

OPERATION MANUAL

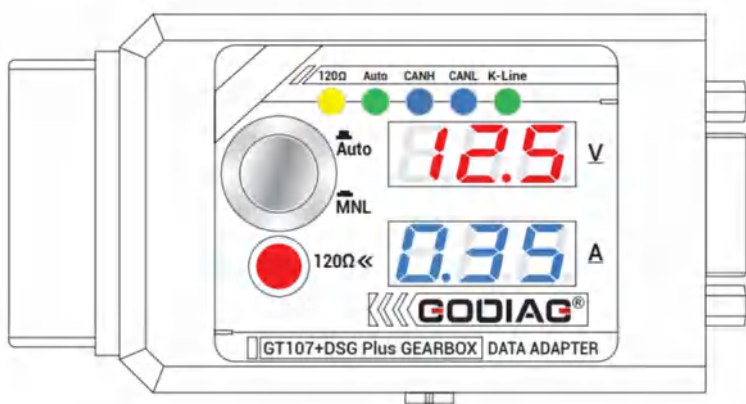

Gearbox Plus Data Adapter

GT107+

1.Content

1.Disclaimer	2
2.Safety Precautions.....	3
3.Product Introduction	4
4.Product Structure.....	6
5.Supported ECU Models.....	7
6.Connection Diagram &Operation Steps.....	8
7. Connection Definition.....	11
8.Precautions.....	15
9.Packing List.....	19
10.Warranty Service.....	19

1.Disclaimer

Please review the following statement carefully:

The statement can help you quickly learn how to use GODIAG products. Please abide by the relevant local laws. If you use the GODIAG equipment illegally, the user shall bear all the risks, and the company will not assume any responsibility.

For the safety of yourself and others, and to avoid damage to equipment and vehicles, please read the safety precautions carefully. Due to the variety of procedures, tools, parts and techniques used in vehicle maintenance, the variability in how personnel operate, and the variety of diagnostic programming applications, this manual cannot predict and provide safety recommendations for every situation.

It is the responsibility of the automotive service technician to get a thorough understanding of the system being tested and to use appropriate service methods and testing procedures reasonably.

When testing, you must use appropriate operating methods to avoid threats to yourself and others in the work area, as well as to avoid damage to the equipment being used or the vehicle being tested.

Before using the equipment, please refer to and follow the safety information and applicable test procedures provided by the vehicle or equipment manufacturer. Please use the equipment in accordance with the instructions in this manual, and read, understand and follow all safety information and instructions in the manual.

2.Safety Precautions

Note for reading and writing ECU data:

1. Connect the DSG gearbox in the studio to read and write data, be sure to use a stable and reliable power supply (12V 4A-5A). Note: Insufficient power supply can cause ECU damage or data loss.

2. If the car battery is connected as the power supply, it must be ensured that the voltage is at 12V and there is enough power in the vehicle battery (to support power for at least 30 minutes). It is recommended that you can start the car first and then connect the device. Note: Insufficient power supply can cause ECU damage or data loss.

3. View the DSG gearbox wiring definition and connect the DSG gearbox.

4. The “Auto” mode and “Manual” mode selection of the GT107+ start switch is selected according to how you want to operate (the switch is popped up to be “Auto”, and the switch is pressed down to be “Manual” . The “Manual” mode is used for PCMFlash software diagnosis. It is recommended to use the “Auto” mode for reading and writing data. Other software uses “Manual” mode.)

5. Since some ECU operations require special attention, please read the following content carefully.

3.Product Introduction

GODIAG GT107+ DSG gearbox Plus data adapter is a DSG gearbox connection adapter.

GODIAG GT107+ DSG gearbox Plus data adapter can help maintenance engineers to read and write data, adjust data or power, clone ECU, diagnose, and repair DSG Gearbox ECU via PCMFlash, PCMTuner, Kessv2 and other devices.

The adapter can display the working voltage and current of the current gearbox ECU, which is convenient for engineers to judge the working condition of the current gearbox ECU. Moreover, the adapter has a BOOT cable and a probe, which is convenient for users to connect to the ECU for reading and writing.

The adapter has automatic and manual selection for PCMFlash software. Please select “automatic” for data reading and writing, and “manual” for diagnosis. For other software kessv2, users need to press the 120 ohm resistance switch, for DQ200, DQ250, DQ500 please select “manual”.

Connect the power cord with battery clips to GT107+, then you can directly read and write DSG gearbox data with the power drawn from the car battery. During the data reading and writing process, the user can clearly check the current communication status through the communication protocol indicator light.

Product Features:

1. The adapter is suitable for connecting VAG series gearbox ECUs, supporting gearbox ECU DQ250, DQ200, VL381, VL300, DQ500, DL501, Benz, BMW...

2. Voltage display: the user can know the current operating voltage of the gearbox ECU. If there is a short circuit or wrong wiring, the voltage will drop severely, which can be used to judge the problem.

3. The current display can display the current working current of the gearbox ECU, which is used to judge the working condition of the gearbox ECU.

4. The communication indicator can display the current CANbus K-Line communication status.

5. Manual and automatic power switch, 120 ohm switch. There are boot mode cable (DB9 DSG gearbox universal conversion jumper) and a probe.

6. Detachable gold-plated DB9 connection interface, users can make professional connection ports by themselves to realize DIY development.

7. Equipped with power cord that has battery clips. Users can draw power from the vehicle battery.

4. Product Structure

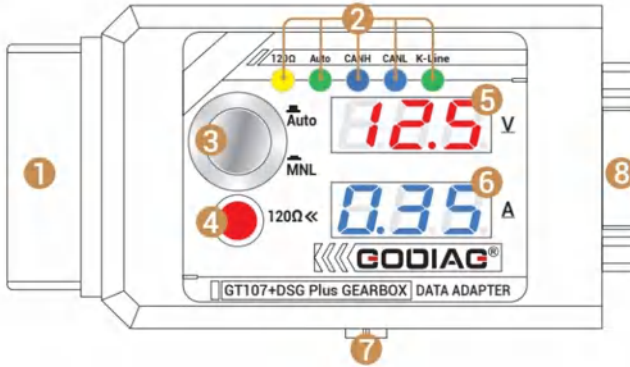

1. OBD2 female interface
2. Indicator light group
3. Automatic /manual power analog ignition switch
4. 120Ω switch
5. Voltage display
6. Current display
7. DC power interface
8. DB9 gold-plated Gearbox ECU cable interface

DB9 definition introduction

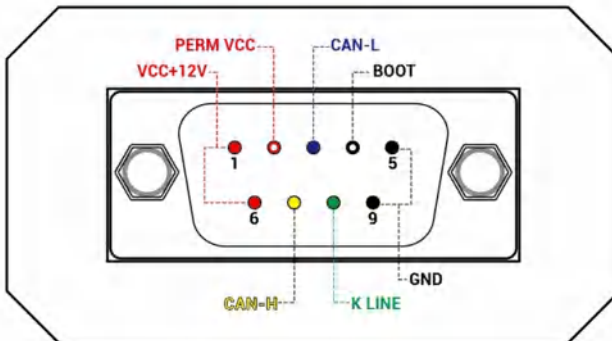

5. Supported ECU Models

GODIAG GT107+ DSG Gearbox Plus Data Adapter Support Connecting:

Renault DC0/DC4 Gen2

Honda LUK UDCT

DQ200 (0AM) [WR/CK]

DQ250C (02E) [RD/WR/CK]

DQ250E/F (02E) [WR/CK]

DQ200MQB/G2 (0CW) [WR/CK]

DQ250MQB (0D9) [WR/CK]

VL300/V30 (01J/0AN) [WR/CK]

VL381 (0AW) [WR/CK]

DL501/G2 (0B5) [WR/CK]

DQ500 (0BH/0BT) [RD/WR/CK] reading when using a direct connection.

DQ200/MQB/G2 Boot (MICRO) [RD/WR/CK]

DQ200/MQB/G2 Boot (EEPROM) [RD/WR]

DQ250E/F/MQB Boot (MICRO) [RD/WR/CK]

DQ250E/F/MQB Boot (EEPROM) [RD/WR]

VL300/V30 BSL (FLASH) [RD/WR/CK]

VL300/V30 BSL (EEPROM) [RD/WR/CK]

VL381 Boot (MICRO) [RD/WR/CK]

VL381 Boot (EEPROM) [RD/WR]

DL501/G2 Boot (MICRO) [RD/WR/CK]

DL501/G2 Boot (EEPROM) [RD/WR]

MERCEDES-BENZ:

722.9---7G tronic

9GT (VGS-NAG3)

VGS (722.8)

BMW EGS 6HP

TEMIC DKG ZF 8HP Gearbox : BMW, JLR, VW/AudiRolls-Royce,
Porsche, Bentley,

AstonMartin, Lamborghini, Maserati, DodgeJeep, Chrysler, etc

BMW 7-dual-clutch (GETAG 7DCT) Gearbox

DQ 400

6.Connection Diagram & Operation Steps

Maintenance Workshop Connection Diagram:

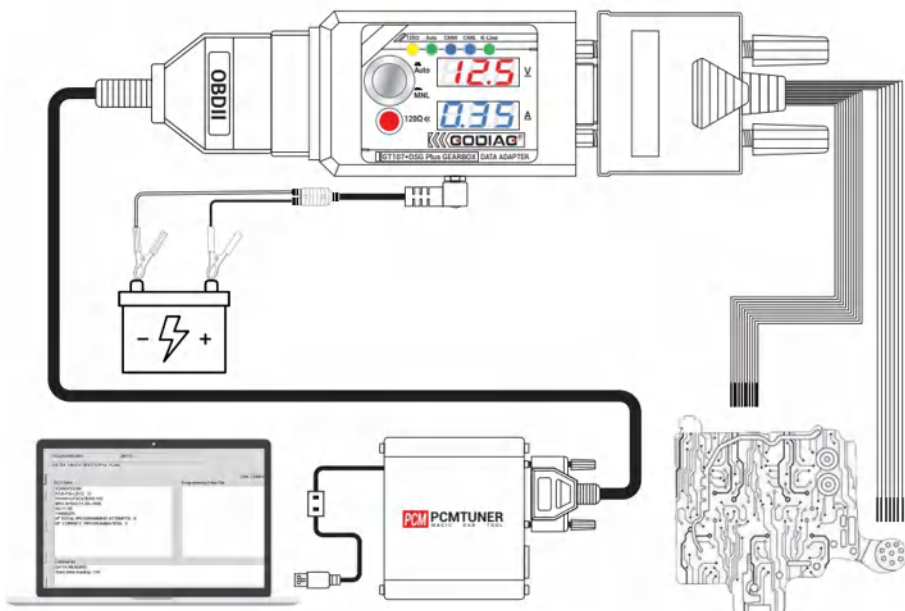

Operation Steps:

1. Connect the Godiag GT107+ to the gearbox ECU according to the gearbox ECU wiring definition. For VAG DQ250, DQ200, VL381, VL300, DQ500, DL501, for Renault DC0/DC4, Gen2, for Honda LUK UDCT.

2. Connect the 12V 2A DC power supply. (The function buttons must be popped up before connecting the power supply.)

3. GODIAG GT107 + analog ignition switch is in “automatic” mode if the ignition switch is not pressed, the voltage and current data of the adapter displays 0V 0A, and it is in “manual” mode, if the ignition switch is pressed, the adapter displays the current working voltage of the power supply, and the current working current of gearbox ECU. (Note: please select the “automatic” or “manual” analog ignition mode, according to the mode required by the device for reading and writing data,)

4. Connect PCMFlash, PCMTuner, J2534passthru.

5. Perform data reading and writing operations.

Car Connection Diagram

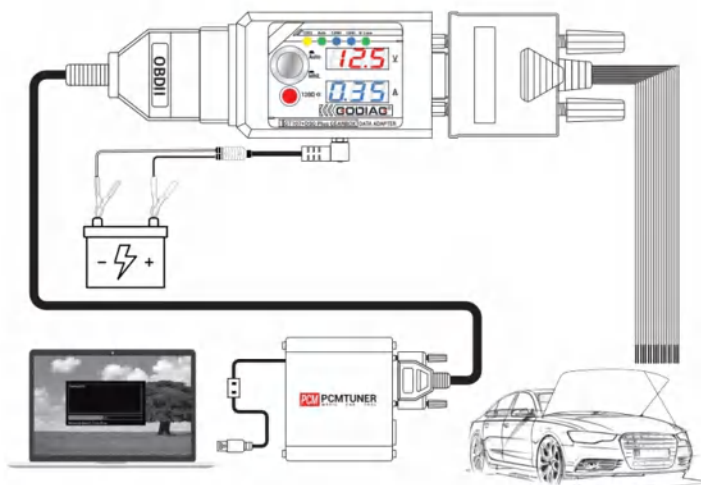

Operation Steps:

1. According to the wiring definition of Gearbox ECU, connect Godiag GT107+ to the gearbox ECU. For VAG DQ250, DQ200, VL381, VL300, DQ500, DL501, for Renault DC0/DC4, Gen2, for Honda LUK UDCT.

2. Connect the 12V 2A DC power supply. (The function buttons must be popped up before connecting the power supply.)

3. GODIAG GT107 + analog ignition switch is in “automatic” mode if the ignition switch is not pressed, the voltage and current data of the adapter displays 0V 0A, and it is in “manual” mode, if the ignition switch is pressed, the adapter displays the current working voltage of the power supply, and the current working current of gearbox ECU. (Note: please select the “automatic” or “manual” analog ignition mode, according to the mode required by the device for reading and writing data,)

4. Connect PCFlash, PCMTuner, J2534passthru.

5. Perform data reading and writing operations.

Workshop Diagnostics or Other Equipment Manual Connection Operation

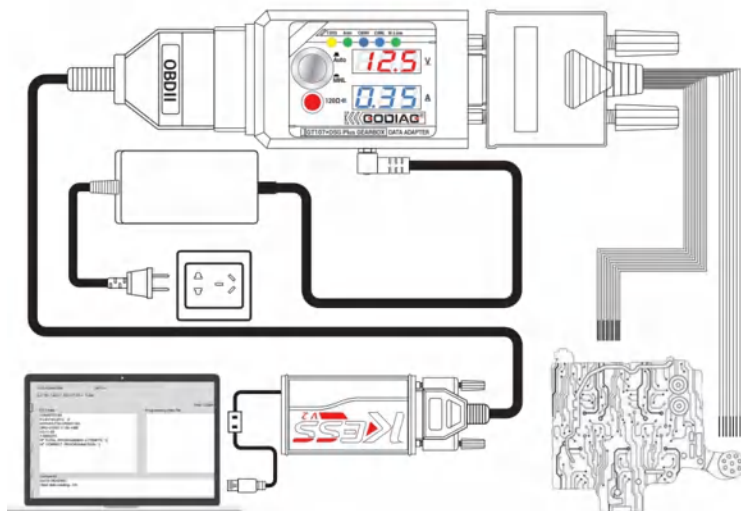

Manual ignition analog switch operation steps:

1. Connect the Godiag GT107+ to the gearbox ECU according to the gearbox ECU wiring definition. For VAG DQ250, DQ200, VL381, VL300, DQ500, DL501, for Renault, DC0/DC4, Gen2, for Honda LUK UDCT, Benz, BMW, gearbox ECU.

2. Connect the 12V 2A DC power supply. (The function buttons must be popped up before connecting the power supply.)

3. GODIAG GT107 + analog ignition switch is in “manual” mode if the ignition switch is pressed, the adapter displays the current working voltage of the power supply, and the current working current of gearbox ECU.

4. Connect OBD2 data reading and writing device or diagnostic device.

5. Perform Gearbox ECU data reading, writing or diagnostic operations.

7.Connection Definition

Gearbox ECU Interface Connection Definition

DQ200(0AM,0CW)

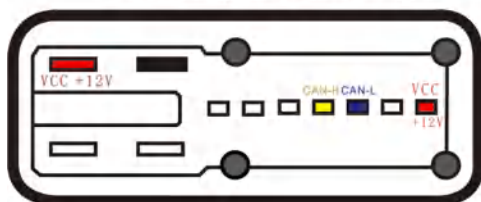

DQ 250 (02E,0D9)

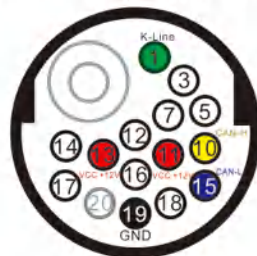

VL381(0AW)

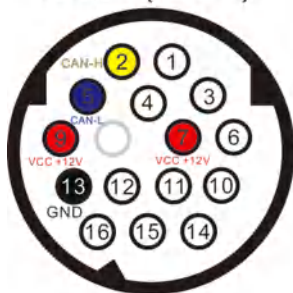

DQ500(0BT,0BH)
DQ380 DQ381

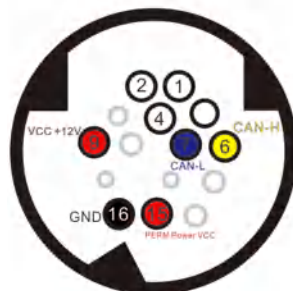

DQ 400

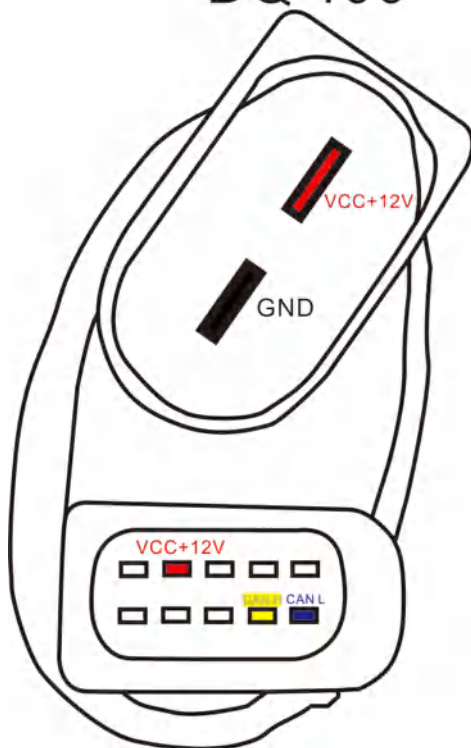

V30 (01J)

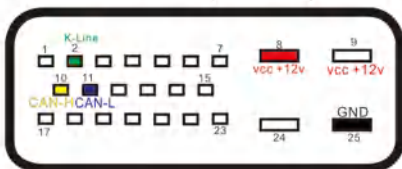

VL 300 (01J)

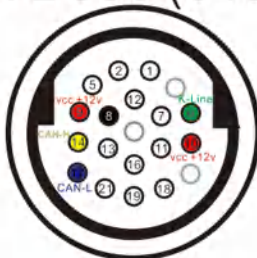

DQ200(0AM,0CW)

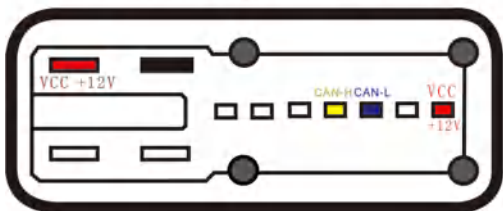

DQ 250 (02E,0D9)

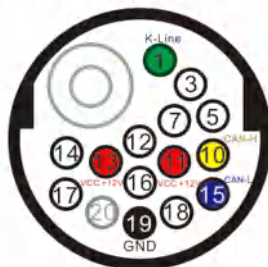

VL381(0AW)

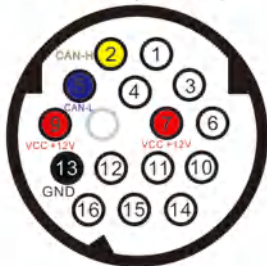

DQ500(0BT,0BH)
DQ380 DQ381

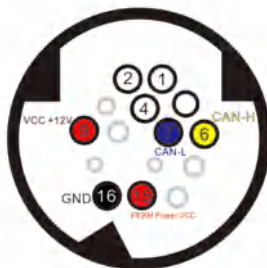

MERCEDES-BENZ

722.9---7G tronic

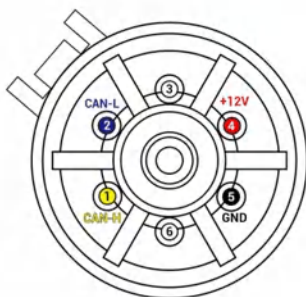

9GT (VGS-NAG3)

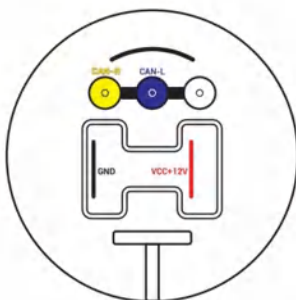

VGS (722.8)

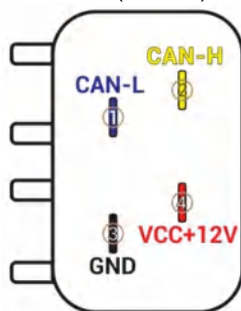

BMW EGS 6HP

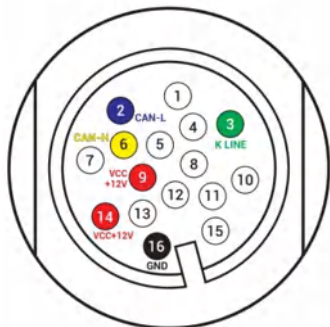

BMW-TEMIC DKG

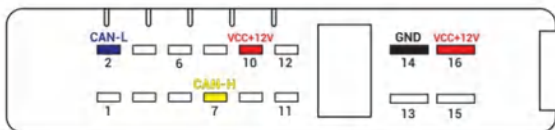

ZF 8HP ZF 8HP gearbox : BMW, JLR, VW/AudiRolls-Royce, Porsche, Bentley, AstonMartin, Lamborghini, Maserati, DodgeJeep, Chrysler, etc

VERSION 1

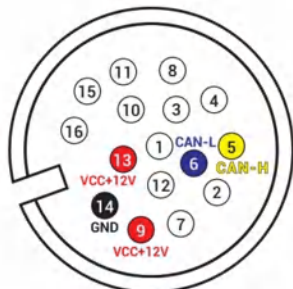

VERSION 2

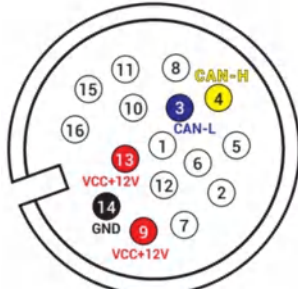

VERSION 3

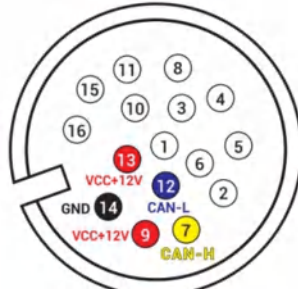

BMW 7-dual-clutch (GETAG 7DCT) gearbox Pinout

VERSION I

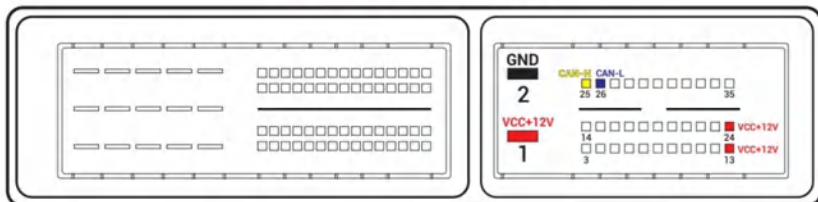

VERSION II

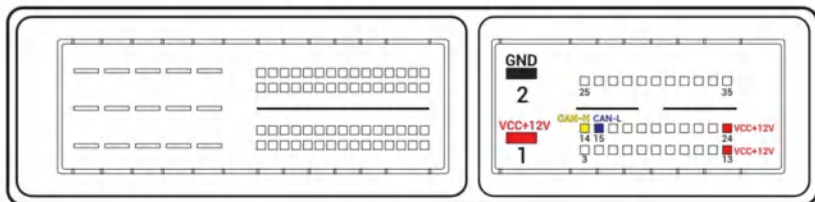

8. Precautions

Precautions for PCMflash or PCMtunerflash to read and write DQ500:

Work BOOT: use a direct connection to the connector of the control UNIT, the switching power supply is carried out either manually (recommended) or by using the scheme of automatic power control, GODIAG GT107 DSG gearbox data adapter (same PowerBox or converted from KESS). In case of manual control, the entrance to the boot mode may not happen on the first attempt.

Read DQ500: only when connected directly!

NOTE: the power supply must be switched manually, while only the ignition must be switched on or off (pin 15), the second contact must be connected constantly.

DQ500(0BT,0BH)

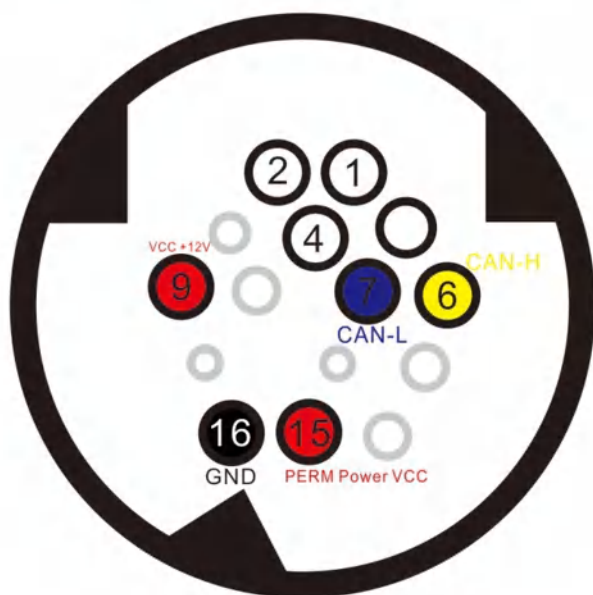

Operation in BSL with VL300 / V30: requires drilling a single hole in the minimum diameter cap in order to insert a probe into it. The probe is connected to the GODIAC GT107+ DSG Gearbox Data Adapter BOOT 1k ohm GND line(included in the GT107+ host). It is mandatory to connect to-line and it is highly recommended to use auto power to quickly “feel” the pin on the board.

The pictures below show the drilling location and the point on the board where the probe should go.

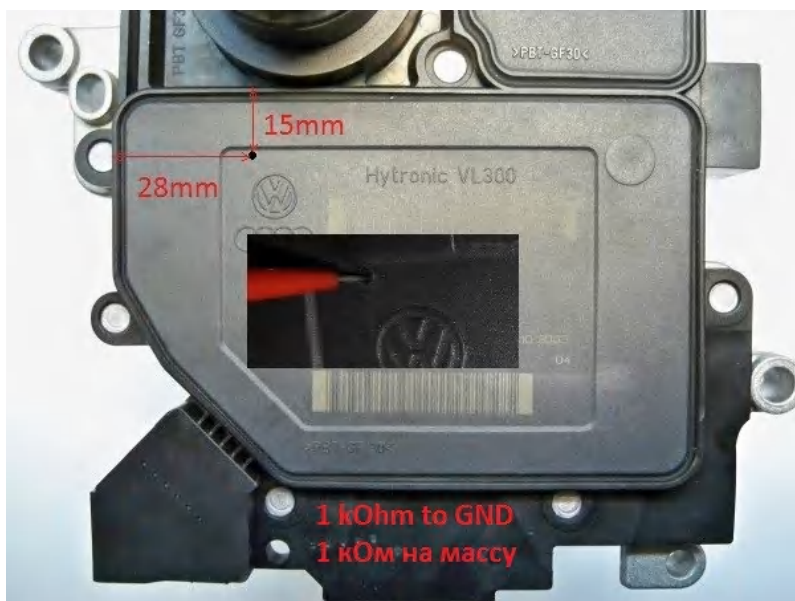
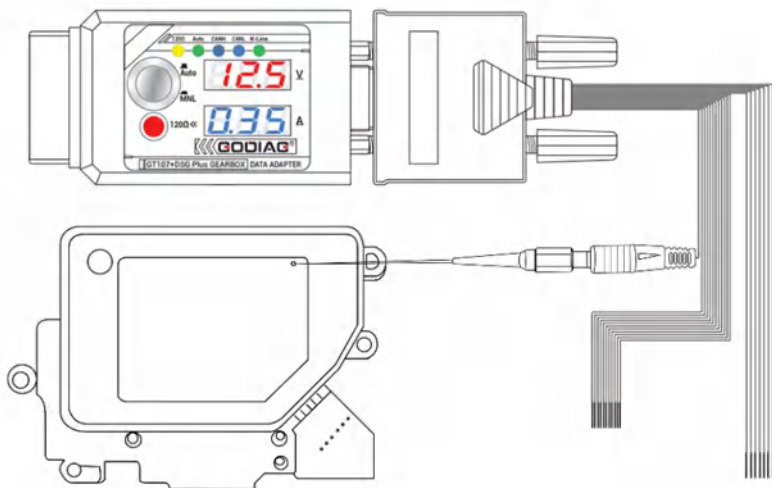

The connection pin picture after disassembling the ECU

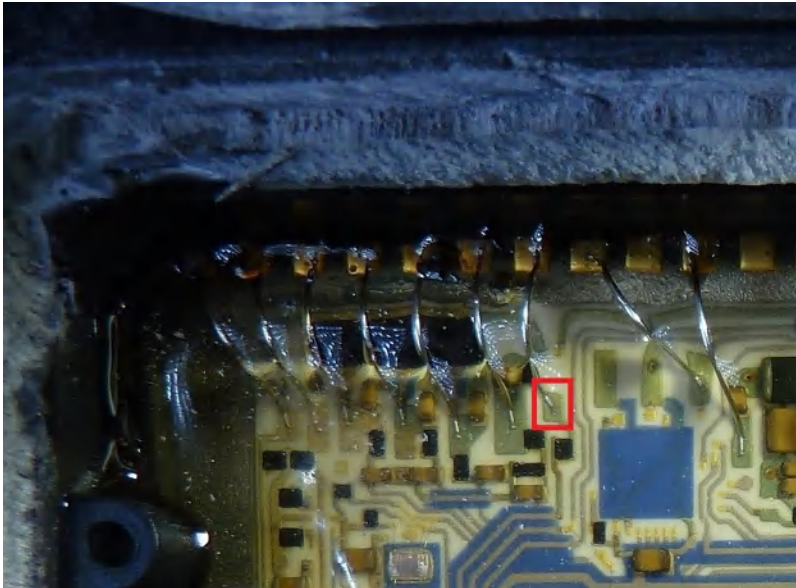
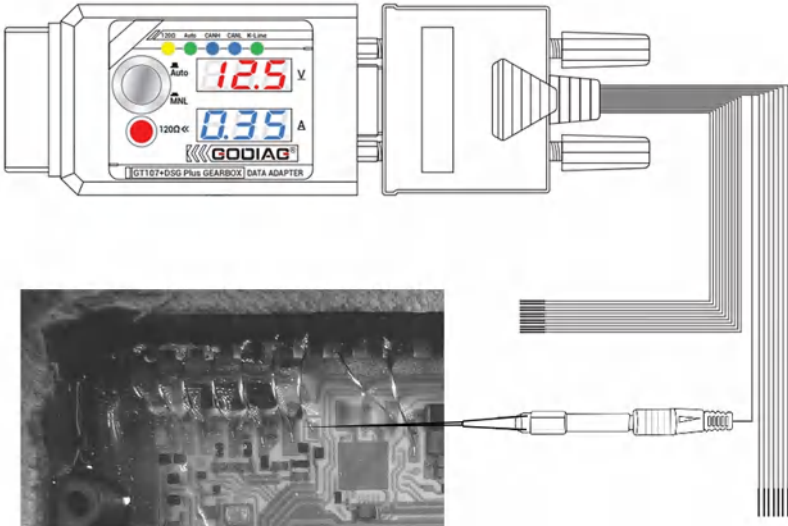

9. Packing List

Package Includes:

1pc x Godiag GT107+ ECU Prog AD

1pc x DB9 DSG Gearbox Universal Conversion Jumper

1pc x Power Cord with Battery Clips

1pc x Probe

1pc x Manual

10. Warranty Service

This product provides one-year warranty service.

This warranty does not apply to damages caused by improper use, accident, flood, lightning, or if the product was altered or repaired by anyone other than the Manufacturer's Service Center.

If the device needs to be repaired, please fill in the service information below:

Contact name

Return address

Phone Number

Concise and Comprehensive Problem Description:

Proof of Purchase

Send the device to the local dealer.

GODIAC®



ABOUT **US**

SHENZHEN SINOY TECHNOLOGY CO.,LTD

🌐 | www.godiag.com

✉ | Sales@GoDiag.com

☎ | +86 18813687743

📍 | Room, 301, Building 1, Bada Industrial Park, No.9 Tangkeng Road, Liuyue Community, Henggang Street, Longgang District, Shenzhen