

Trademarks

Autel®, MaxiSys®, MaxiPRO®, MaxiScan®, MaxiCheck®, MaxiRecorder®, and MaxiPRO® are trademarks of Autel Intelligent Technology Corp., Ltd., registered in China, the United States and other countries. All other marks are trademarks or registered trademarks of their respective holders.

Copyright Information

No part of this manual may be reproduced, stored in a retrieval system or transmitted, in any form or by any means, electronic, mechanical, photocopying, recording, or otherwise without the prior written permission of Autel.

Disclaimer of Warranties and Limitation of Liabilities

All information, specifications and illustrations in this manual are based on the latest information available at the time of printing.

Autel reserves the right to make changes at any time without notice. While information of this manual has been carefully checked for accuracy, no guarantee is given for the completeness and correctness of the contents, including but not limited to the product specifications, functions, and illustrations.

Autel will not be liable for any direct, special, incidental, indirect damages or any economic consequential damages (including the loss of profits).

IMPORTANT

Before operating or maintaining this unit, please read this manual carefully, paying extra attention to the safety warnings and precautions.

For Services and Support

 pro.autel.com
www.autel.com

 1-855-288-3587/1-855-AUTELUS (North America)
0086-755-86147779 (China)

 support@autel.com

For technical assistance in all other markets, please contact your local selling agent.

Safety Information

For your own safety and the safety of others, and to prevent damage to the device and vehicles upon which it is used, it is important that the safety instructions presented throughout this manual be read and understood by all persons operating or coming into contact with the device.

There are various procedures, techniques, tools, and parts for servicing vehicles, as well as in the skill of the person doing the work. Because of the vast number of test applications and variations in the products that can be tested with this equipment, we cannot possibly anticipate or provide advice or safety messages to cover every circumstance. It is the automotive technician's responsibility to be knowledgeable of the system being tested. It is crucial to use proper service methods and test procedures. It is essential to perform tests in an appropriate and acceptable manner that does not endanger your safety, the safety of others in the work area, the device being used, or the vehicle being tested.

Before using the device, always refer to and follow the safety messages and applicable test procedures provided by the manufacturer of the vehicle or equipment being tested. Use the device only as described in this manual. Read, understand, and follow all safety messages and instructions in this manual.

Safety Messages

Safety messages are provided to help prevent personal injury and equipment damage. All safety messages are introduced by a signal word indicating the hazard level.

DANGER

Indicates an imminently hazardous situation which, if not avoided, will result in death or serious injury to the operator or to bystanders.

WARNING

Indicates a potentially hazardous situation which, if not avoided, could result in death or serious injury to the operator or to bystanders.

Safety Instructions

The safety messages herein cover situations Autel is aware of. Autel cannot know, evaluate or advise you as to all of the possible hazards. You must be certain that any condition or service procedure encountered does not jeopardize your personal safety.

 **DANGER**

When an engine is operating, keep the service area **WELL VENTILATED** or attach a building exhaust removal system to the engine exhaust system. Engines produce carbon monoxide, an odorless, poisonous gas that causes slower reaction time and can lead to serious personal injury or loss of life.

 **SAFETY WARNINGS**

- Always perform automotive testing in a safe environment.
- Wear safety eye protection that meets ANSI standards.
- Keep clothing, hair, hands, tools, test equipment, etc., away from all moving or hot engine parts.
- Operate the vehicle in a well-ventilated work area, for exhaust gases are poisonous.
- Put the transmission in **PARK** (for automatic transmission) or **NEUTRAL** (for manual transmission) and make sure the parking brake is engaged.
- Put blocks in front of the drive wheels and never leave the vehicle unattended while testing.
- Be extra cautious when working around the ignition coil, distributor cap, ignition wires and spark plugs. These components create hazardous voltages when the engine is running.
- Keep a fire extinguisher suitable for gasoline, chemical, and electrical fires nearby.
- Do not connect or disconnect any test equipment while the ignition is on or the engine is running.
- Keep the test equipment dry, clean, free from oil, water or grease. Use a mild detergent on a clean cloth to clean the outside of the equipment as necessary.
- Do not drive the vehicle and operate the test equipment at the same time. Any distraction may cause an accident.
- Refer to the service manual for the vehicle being serviced and adhere to all diagnostic procedures and precautions. Failure to do so may result in personal injury or damage to the test equipment.
- To avoid damaging the test equipment or generating false data, make sure the vehicle battery is fully charged and the connection to the vehicle DLC is clean and secure.
- Do not place the test equipment on the distributor of the vehicle. Strong electro-magnetic interference can damage the equipment.

CONTENTS

- Safety Informationii
- Safety Messagesii
- Safety Instructions.....ii
- 1 Using This Manual 1
 - Conventions 1
- 2 General Introduction..... 3
 - MaxiPRO MP808BT Display Tablet4
 - VCI – Vehicle Communication Interface8
 - Other Accessories 10
- 3 Getting Started..... 11
 - Powering Up 11
 - Powering Down..... 15
- 4 Diagnostics 16
 - Establishing Vehicle Communication 16
 - Getting Started 18
 - Vehicle Identification 20
 - Navigation 25
 - Diagnostics Screen Layout..... 25
 - Diagnosis 28
 - Generic OBD II Operations 40
 - Exiting Diagnostics 44
- 5 Service 46
 - Oil Reset Service..... 46
 - Electronic Parking Brake (EPB) Service..... 50
 - Battery Management System (BMS) Service 53
 - Steering Angle Sensor (SAS) Service 56
 - Diesel Particle Filter (DPF) Service 64
- 6 Data Manager 72
 - Operations 72
- 7 Settings 77
 - Unit 77

Language	78
Printing Setting	79
Notification Center	81
Auto Update	82
System Settings	83
About	84
8 Update.....	85
Tablet Update	85
MaxiVCI Mini Update	87
9 VCI Manager.....	88
BT Pairing	88
Update	89
Programmer Update	89
10 Shop Manager.....	90
Vehicle History	91
Workshop Information	93
Customer Manager	94
11 Academy.....	97
12 Remote Desk.....	98
13 MaxiFix.....	100
Navigation	100
Operations	103
14 Support.....	110
Product Registration	110
Support Screen Layout	111
My Account	111
User Complaint	112
Data Logging	114
Communities	115
Training Channels	117
FAQ Database	118
15 Quick Link.....	119
16 Function Viewer.....	120

17 Maintenance and Service	123
Maintenance Instructions	123
Troubleshooting Checklist	124
About Battery Usage	124
Service Procedures	126
18 Compliance Information	129
19 Warranty	132
Limited One Year Warranty	132

1 Using This Manual

This manual contains device usage instructions.

Some illustrations shown in this manual may contain modules and optional equipment that are not included in your system. Contact your sales representative for availability of other modules and optional tools or accessories.

Conventions

The following conventions are used.

Bold Text

Bold text is used to highlight selectable items such as buttons and menu options.

Example:

- Tap **OK**.

Notes and Important Messages

Notes

A **NOTE** provides helpful information such as additional explanations, tips, and comments.

Example:

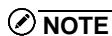

NOTE

New Batteries reach full capacity after approximately 3 to 5 charging and discharging cycles.

Important

IMPORTANT indicates a situation which, if not avoided, may result in damage to the test equipment or vehicle.

Example:



IMPORTANT

Keep the cable away from heat, oil, sharp edges and moving parts. Replace damaged cables immediately.

Hyperlink

Hyperlinks, or links, that take you to other related articles, procedures, and illustrations are available in electronic documents. Blue italic text indicates a selectable hyperlink and blue underlined text indicates a website link or an email address link.

Illustrations

Illustrations used in this manual are samples, the actual testing screen may vary for each vehicle being tested. Observe the menu titles and on-screen instructions to make correct option selection.

2 General Introduction

Featuring the powerful Cortex-A9 processor, and a 7.0 inch LCD capacitive touch screen, based on the Android multitasking operating system, and combined with the ability to quickly read and clear DTCs for all available modules of the majority of the makes and models on the market, the MaxiPRO MP808BT is your ideal auto diagnostic and service tool. MP808BT provides you with superior special functions, including Oil Reset, EPB (Electronic Parking Brake), SAS (Steering Angle Sensor), BMS (Battery Management System), and DPF (Diesel Particulate Filter).

There are two main components of the MP808BT system:

- MP808BT Display Tablet – the central processor and monitor for the system.
- MaxiVCI Mini (Vehicle Communication Interface) – the device for accessing vehicle data.

This manual describes the construction and operation of both devices and how they work together to deliver diagnostic solutions.

MaxiPRO MP808BT Display Tablet

Functional Description

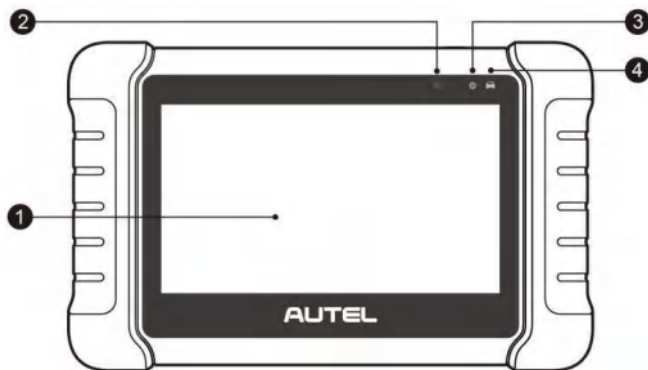

Figure 2-1 Display Tablet Front View

1. 7.0" LCD Capacitive Touchscreen.
2. Ambient Light Sensor – detects ambient brightness.
3. Power LED – indicates battery level & charging or system status.
4. Vehicle Communication LED – flashes green when the Display Tablet is communicating/linking with the vehicle' s system.

The power LED displays green, yellow or red depending on power level and operating state.

A. Green

- Illuminates green when the Display Tablet is charging and the battery level is above 90%.
- Illuminates green when the Display Tablet is powered on and the battery level is above 15%.

B. Yellow

- Illuminates yellow when the Display Tablet is charging and the battery level is below 90%.

C. Red

- Illuminates red when the Display Tablet is powered on and the battery level is below 15%.

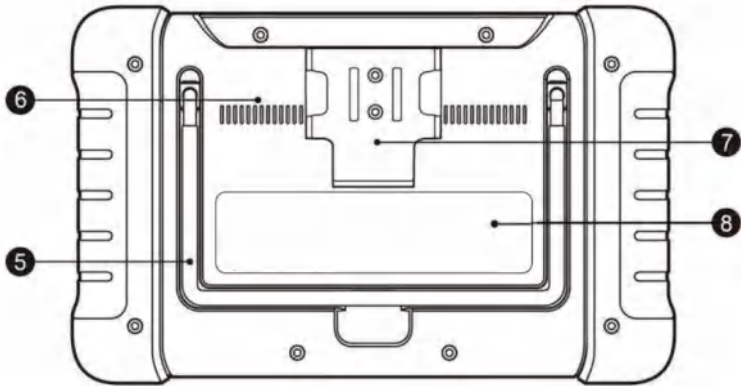

Figure 2-2 Display Tablet Back View

5. Collapsible Stand – extends from the back to allow hands-free viewing of the Display Tablet.
6. Heat Sink
7. MaxiVCI Mini Holder
8. Built-in Battery

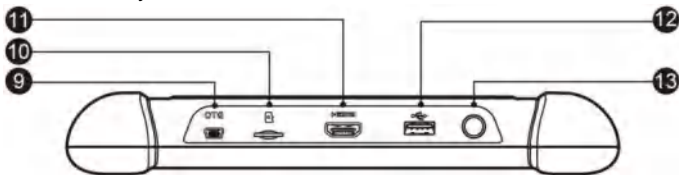

Figure 2-3 Display Tablet Top View

9. Mini USB OTG Port
10. Micro SD Card Slot – holds the micro SD card.
11. HDMI (High-Definition Multimedia Interface) Port
12. USB Port
13. Lock/Power Button – turns the device on & off with long press, or locks the screen with short press.

Power Sources

The tablet can receive power from any of the following sources:

- Internal Battery Pack
- External Power Supply

Internal Battery Pack

The tablet can be powered with the internal rechargeable battery, which if fully charged can provide sufficient power for about 7 hours of continuous operation.

External Power Supply

The tablet can be powered from a wall socket using the USB charging cable and the USB external power adapter. The external power supply also charges the internal battery pack.

Technical Specifications

Table 2-1 Specifications

Item	Description
Recommended Use	Indoor
Operating System	Android™ 4.4.2, KitKat
Processor	Cortex-A9 processor (1.5 GHz)
Memory	64GB
Display	7-inch LCD capacitive touchscreen with 1024 x 600 resolution
Connectivity	<ul style="list-style-type: none"> ● Mini USB 2.0 ● USB 2.0 ● Wi-Fi ● HDMI Type A ● Micro SD card (supports up to 32GB)
Sensors	Light sensor for brightness auto changing

Item	Description
Audio input/output	<ul style="list-style-type: none"> ● Input: N/A ● Output: buzzer
Power and Battery	<ul style="list-style-type: none"> ● 3.7 V/5000 mAh lithium-polymer battery ● Charges via 5 VDC power supply
Tested Battery Life	Around 7 hours of continuous use
Battery Charging Input	5 V/1.5 A
Power Consumption	600 mA (LCD on with default brightness, Wi-Fi on) @3.7 V
Operating Temp.	0 to 55°C(32 to 131°F)
Storage Temp.	-20 to 60°C (-4 to 140°F)
Operating Humidity	5% - 95% non-condensing
Dimensions (W x H x D)	237.8 mm (9.4") x 148.6 mm (5.9") x 35.5 mm (1.4")
Net Weight	788 g (2.42 lb.)
Protocols	ISO9141-2, ISO14230-2, ISO15765, K/L-Line, Flashing Code, SAE-J1850 VPW, SAE-J1850PWM, ISO11898 (Highspeed, Middlespeed, Lowspeed and Singlewire CAN, fault-tolerant CAN), SAE J2610,GM UART,UART Echo Byte Protocol, Honda Diag-H Protocol, TP2.0, TP1.6

VCI – Vehicle Communication Interface

The wireless diagnostic interface MaxiVCI Mini is a small vehicle communication interface (VCI) used to connect to a vehicle's data link connector (DLC) and connect wirelessly with the tablet for vehicle data transmission.

Functional Description

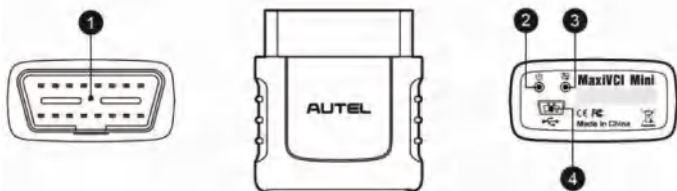

Figure 2-4 MaxiVCI Mini Views

1. Vehicle Data Connector (16-Pin) – connects the MaxiVCI Mini to the vehicle's 16-pin DLC directly.
2. Power LED – refer to [Table 2-2 Power LED on the Front Panel](#) on page 8 for details.
3. Connection LED – refer to [Table 2-3 Connection LED on the Front Panel](#) on page 9 for details.
4. USB Port – provides the easiest connection between the device and the tablet via a USB cable.

Table 2-2 Power LED on the Front Panel

LED	Color	Description
Power	Green	Lights solid green when powered on.
	Red	Blinks red when system failure occurs. <i>Note: The power LED briefly lights red each time the device powers on and then lights green when the device is ready.</i>

Table 2-3 Connection LED on the Front Panel

LED	Color	Description
Connection	Green	<ul style="list-style-type: none"> • Lights solid green when the device is successfully connected via the USB cable but is not communicating with the vehicle. • Blinks green when the device is successfully connected via the USB cable and is communicating with the vehicle.
	Blue	<ul style="list-style-type: none"> • Lights solid blue when the device is successfully connected via BT but is not communicating with the vehicle. • Blinks blue when the device is successfully connected via BT and is communicating with the vehicle.

Technical Specifications





Table 2-4 Specifications

Item	Description
Communications	<ul style="list-style-type: none"> • BT V.2.1 + EDR • USB 2.0
Wireless Frequency	2.4 GHz
Input Voltage Range	12 VDC to 24 VDC
Supply Current	150 mA @ 12 VDC
Operating	0°C to 50°C (ambient)
Storage	-20°C to 70°C (ambient)
Dimensions (L x W x H)	47 mm (1.7") x 23 mm (0.9") x 51 mm (2.0")
Weight	33.1g (0.07 lb.)

Power Sources

The MaxiVCI Mini operates on 12-volt vehicle power, which is received through the vehicle's DLC. The unit powers on whenever it is connected to the vehicle's DLC.

Other Accessories

	MaxiVCI Mini Connects to the vehicle's DLC and provides wireless connection between the tablet and the vehicle.
	USB Cable (for test) 2 m
	USB Cable (for charging) 90 cm
	USB External Power Adapter Together with the mini USB cable, connects the tablet to the external DC power port for power supply.

3 Getting Started

Ensure the tablet is sufficient charged or is connected to the external power supply (see [Power Sources](#) on page 10).

NOTE

The images and illustrations depicted in this manual may differ slightly from the actual ones.

Powering Up

Long press the Lock/Power button on the top right side of the tablet to power on the unit. The power LED light will illuminate green. The system boots up and displays the lock screen. Slide the Lock icon to the left to enter the MaxiPRO Job Menu or slide to the right to unlock.

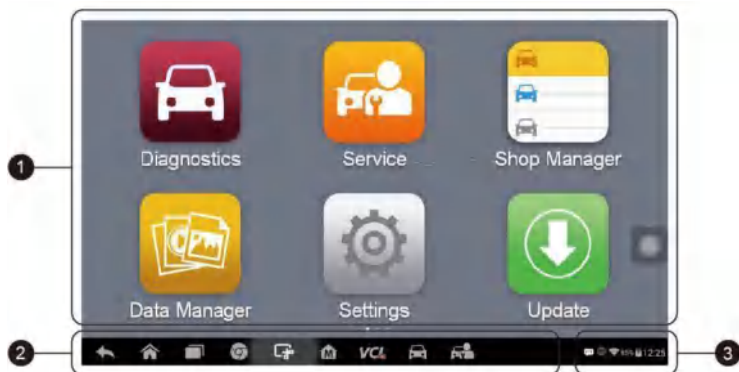

Figure 3-1 Sample MaxiPRO MP808BT Job Menu

1. Application Buttons
2. Locator and Navigation Buttons
3. Status Icons

NOTE







The tablet screen is locked by default when first powered on. It is recommended to lock the screen to protect the information in the system and reduce the power consumption.





The touch screen navigation is menu driven enabling quickly access to functions and features by tapping on options headings and answering dialog windows. Detailed descriptions of the menu structures are found in the application chapters.

Application Buttons

Descriptions of the tool applications are displayed in the table below.

Table 3-1 Applications



Button	Name	Description
	Diagnostics	Accesses diagnostic functions menu. See Diagnostics on page 16.
	Service	Accesses special functions menu. See Service on page 46.
	Shop Manager	Allows you to edit and save workshop information and customer data, as well as reviewing test vehicle history records. See Shop Manager on page 90.
	Data Manager	Accesses the organization system for saved data files. See Data Manager on page 64.
	Settings	Accesses MaxiPRO system settings menu and general tablet menu. See Settings on page 77.
	Update	Checks for the latest update available for the MaxiPRO system, and performs updates. See Update on page 85.
	Support	Launches the Support platform which synchronizes Autel's on-line service base









Button	Name	Description
		station with the MaxiPRO tablet. See Support on page 110 .
	Academy	Accesses technical tutorials and training articles about the device usage and vehicle diagnostic techniques. See Academy on page 97 for details.
	Remote Desk	Configures the unit to receive remote support using the TeamViewer application program. See Remote Desk on page 98 .
	MaxiFix	Launches the MaxiFix platform which provides the most compatible and abundant repair techniques and diagnostics database. See MaxiFix on page 100 .
	Quick Link	Provides associated website bookmarks to allow quick access to product update, service, support and other information. See Quick Link on page 119 .
	Function Viewer	Provides quick search for the supported functions and vehicles of Autel diagnostic tools. See Function Viewer on page 120 .

Locator and Navigation Buttons

Operations of the Navigation buttons at the bottom of the screen are described in the table below:

Table 3-2 Locator and Navigation Buttons

Button	Name	Description
	Locator	Indicates which screen you are on. Swipe the screen left or right to view the previous or next screen.
	Back	Returns to the previous screen.

Button	Name	Description
	Android Home	Returns to Android System's Home screen.
	Recent Apps	Displays a list of applications that are currently in use. Tap an app icon to launch. To remove an app, swipe it to the top or bottom.
	Chrome	Launches the Android built-in browser.
	Screenshot	Takes a screenshot when you want to save the displayed information.
	MaxiPRO Home	Returns to MaxiPRO Job Menu from other operations.
	VCI	Opens the VCI Manager application. The check at the bottom right corner indicates the tablet is communicating with the MaxiVCI Mini. An X will display if the tablet is not connected to VCI.
	Diagnostics Shortcut	Returns to the Diagnostics screen.
	Service Shortcut	Returns to the Service screen.

System Status Icons







As the tablet is working with the Android operating system, you may refer to Android documents for more information.

By up sliding the bottom right corner, a Shortcuts Panel will be displayed, on which you are allowed to set various system settings of the tablet. Operations of each button on the panel are described in the table below:

NOTE

The shortcuts buttons will be highlighted when enabled, and dimmed when disabled.

Table 3-3 System Status Icons

Button	Name	Description
	Calculator	Launches calculator when pressed.
	Clock	Launches clock when pressed.
	BT	Enables/disables BT when pressed.
	Wi-Fi	Enables/disables Wi-Fi when pressed.
	Airplane Mode	Enables/disables Airplane Mode when pressed.
	System Settings	Launches the Android System Settings screen when pressed.

Powering Down

All vehicle communications must be terminated before shutting down the tablet. A warning message displays if you attempt to shut down the tablet while it is communicating with the vehicle. Forcing a shut-down while communicating may lead to ECM problems on some vehicles. Please exit the Diagnostics application before powering down.

➤ To power down the tablet

1. Long press the Lock/Power Button.
2. Tap **Power off** option.
3. Tap **OK**, the tablet will turn off in a few seconds.

Reboot System

In case of system crash, long press the Lock/Power button and tap **Reboot** option to reboot the system.

4 Diagnostics

The Diagnostics application can retrieve ECU information, read & erase DTCs, and view live data. The Diagnostics application can access the electronic control unit (ECU) for various vehicle control systems, including engine, transmission, antilock brake system (ABS), airbag system (SRS).

Establishing Vehicle Communication

The Diagnostics operations require connecting the MaxiPRO MP808BT Diagnostic Platform to the test vehicle through the MaxiVCI Mini. To establish proper vehicle communication to the tablet, please perform the following steps:

1. Connect the MaxiVCI Mini to the vehicle's DLC for both communication and power supply.
2. Connect the MaxiVCI Mini to the tablet via BT pairing.
3. A green check will display atop the VCI navigation button at the bottom bar on the screen. If communication has been established, the MP808BT is ready to start vehicle diagnosis.

Vehicle Connection

The tablet communicates with the vehicle via the BT connection provided by the MaxiVCI Mini.

To connect the MaxiVCI Mini to the test vehicle, simply insert the Vehicle Data Connector on the MaxiVCI Mini into the vehicle's DLC which is generally located under the vehicle dash and the MaxiVCI Mini will be automatically powered on.

NOTE

The vehicle's DLC is not always located under the dash; refer to the vehicle's user manual for DLC location.

VCI Connection

The MaxiVCI Mini Power LED will light solid green when properly connected to the vehicle and ready to establish communication with the tablet.

The wireless diagnostic interface MaxiVCI Mini supports 2 communication methods with the tablet, wireless BT and USB.

BT Connection

BT pairing is recommended as the first choice for the communication between the tablet and the MaxiVCI Mini. The working range for BT communication is about 33 feet (about 10 m), enabling remote vehicle diagnostics.

More than one MaxiVCI Mini to connect to the test vehicles, you can perform vehicle diagnosis on various vehicles conveniently by pairing the tablet separately to each of the MaxiVCI Mini devices connected to the different test vehicles via wireless BT. Without the need to repeat the plugging and unplugging procedure which is unavoidable through traditional wired connection, BT connection saves you more time and provides higher efficiency.

Refer to *BT Pairing* on page 88 for details.

USB Cable Connection

Use the provided USB cable to connect the tablet to the MaxiVCI Mini. A green check will display atop the VCI navigation button at the bottom bar of the screen and the MaxiVCI Mini Connection LED will light solid green when connection between the devices is successful.

NOTE

The USB communication method will take priority over BT communication if both are enabled.

No Communication Message

- A. If the tablet is not connected to the MaxiVCI Mini correctly, an “Error” message may display. This indicates that the tablet cannot access the vehicle control module. In this case, please do the following check-ups:
 - Check if the MaxiVCI Mini is powered up.

- Check if the MaxiVCI Mini is properly positioned.
 - Check if the Connection LED on the MaxiVCI Mini is illuminated for BT or USB.
 - In case of BT connection, check if the network is configured correctly, or if the right MaxiVCI Mini has been paired up with the tablet.
 - ◇ If during the diagnosis process, the communication is suddenly interrupted due to the loss of signal, check if there is any object that causes signal interruption.
 - ◇ Try standing closer to the MaxiVCI Mini to obtain more stable signals and faster communication speed.
 - In case of USB connection, check the cable connection between the tablet and the MaxiVCI Mini.
 - Check if the Power LED on the MaxiVCI Mini is flashing red and if so, it indicates there is a hardware problem with the MaxiVCI Mini, in this case, contact technical support for help.
- B. If the MaxiVCI Mini is unable to establish a communication link, a prompt message displays with check instructions. The following conditions are the possible causes:
- The MaxiVCI Mini is unable to establish a communication link with the vehicle.
 - The system selected for testing is not equipped on the vehicle.
 - There is a loose connection.
 - There is a blown vehicle fuse.
 - There is a wiring fault of the vehicle or the adapter.
 - There is a circuit fault in the adapter.
 - Incorrect vehicle identification was entered.

Getting Started

Ensure a communication link is established between the test vehicle and the tablet via the MaxiVCI Mini.

Vehicle Menu Layout

When the tablet device is properly connected to the vehicle, the platform is ready to start vehicle diagnosis. Tap on the **Diagnostics** application button on the MaxiPRO MP808BT Job Menu to access the Vehicle Menu.



Figure 4-1 Sample Vehicle Menu





1. Top Toolbar Buttons
2. Vehicle Manufacturer Buttons

Top Toolbar Buttons

The operations of the toolbar buttons at the top of the screen are listed and described in the table below:

Table 4-1 Top Toolbar Buttons

Button	Name	Description
	Home	Returns to the MaxiPRO Job Menu.
	VIN Scan	Provides a fast way to identify the test vehicle. See Vehicle Identification on page 20 for details.
	All	Displays all the vehicle manufacturers.
	History	Displays the stored test vehicle history records. See Vehicle History on page 91 for details.
	USA	Displays the USA vehicle menu.

Button	Name	Description
	Europe	Displays the European vehicle menu.
	Asia	Displays the Asian vehicle menu.
	Search	Searches for a specific vehicle make.
	Cancel	Exits the search screen or cancels an operation.

Vehicle Manufacturer Buttons

To begin, select the manufacturer button of the test vehicle, followed by the vehicle mode and year.

Vehicle Identification

The MaxiPRO diagnostic system supports four methods for Vehicle Identification.

1. Auto VIN Scan
2. Manual VIN Input
3. Automatic Selection
4. Manual Selection

Auto VIN Scan

The MaxiPRO diagnostic system features the latest VIN-based Auto VIN Scan function to identify vehicles and scan all the diagnosable ECUs and run diagnostics on the selected system. This function is compatible with 2006 and newer vehicles.

➤ To perform Auto VIN Scan

1. Tap the **Diagnostics** application button from the MaxiPRO Job Menu. The Vehicle Menu displays.
2. Tap the **VIN Scan** button on the top toolbar to open the dropdown list.



Figure 4-2 Sample Auto VIN Screen

3. Select **Auto Detect**. Once the test vehicle is identified, the screen will display the vehicle VIN. Tap **OK** at the bottom right to confirm the vehicle VIN. If the VIN does not match with the test vehicle's VIN, enter VIN manually or tap **Read** to acquire VIN again.
4. Tap **OK** to confirm the vehicle profile or **NO** if the information is not correct.



Figure 4-3 Sample Auto Detect Screen



Figure 4-4 Sample Vehicle Profile Screen

5. The tool establishes communication with the vehicle and reads the control unit information. Choose **Auto Scan** to scan all the test vehicles' available systems or tap **Control Unit** to access a specific system to diagnose.

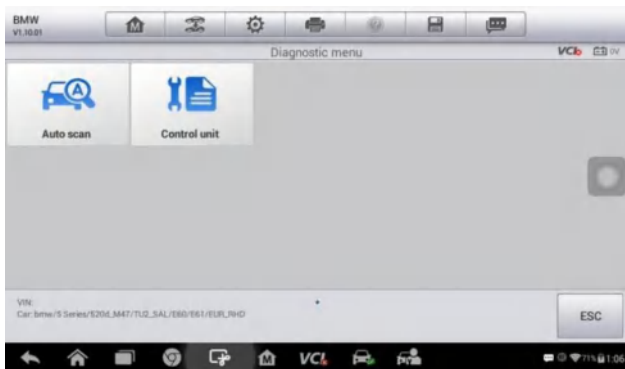

Figure 4-5 Sample Diagnostic Screen

Manual VIN Input

For vehicles not supporting the Auto VIN Scan function, you may manually enter the vehicle VIN.

➤ **To perform Manual VIN Input**

1. Tap the **Diagnostics** application button from the MaxiPRO Job Menu. The Vehicle Menu displays.
2. Tap the **VIN Scan** button on the top toolbar to open the dropdown list.
3. Select **Manual Input**.



Figure 4-6 Sample Diagnostic Screen

4. Tap the input box and enter the correct VIN.
5. Tap **Done**. Once the vehicle is identified, the Vehicle Diagnostics screen displays.
6. Tap **Cancel** to exit Manual Input.

Automatic Selection

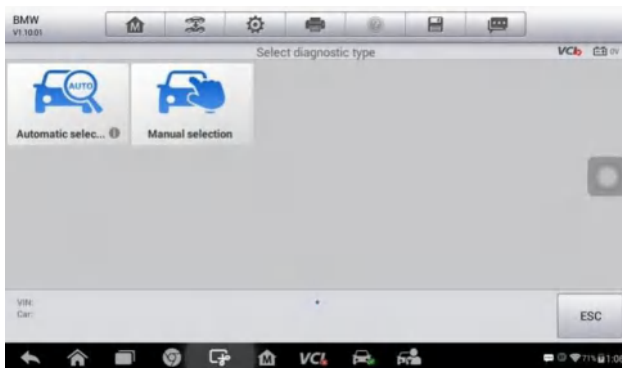

Figure 4-7 Sample Selection Screen

The Auto VIN Scan can be selected after selecting the test vehicle manufacturer.

➤ To perform Automatic Selection

1. Tap the **Diagnostics** application button from the MaxiPRO Job Menu. The Vehicle Menu displays.
2. Tap the manufacturer button of the test vehicle.
3. Tap **Automatic Selection** and the VIN information will be acquired automatically. Follow the on-screen instruction to display the diagnostic screen.

Manual Selection

When the vehicle's VIN is not automatically retrievable through the vehicle's ECU, or the specific VIN is unknown, the vehicle can be manually selected.

This mode of vehicle selection is menu driven, repeat the first two steps from the automatic selection operation and tap **Manual Selection**. Through a series of on-screen prompts and selections, the test vehicle is chosen. If needed, press the **Back** button at the bottom right corner of the screen to return to previous screen.

Navigation

Navigating the Diagnostics interface and selecting test are discussed in this section.

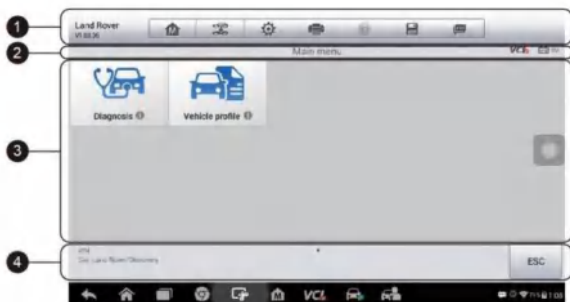

Figure 4-8 Sample Diagnostics Screen

Diagnostics Screen Layout







The diagnostic screens typically include four sections.

1. Diagnostics Toolbar
2. Status Information Bar
3. Main Section
4. Functional Buttons

Diagnostics Toolbar

The Diagnostics Toolbar contains a number of buttons such as print and save. The table below provides a brief description of the operations of the Diagnostics Toolbar buttons.

Table 4-2 Diagnostics Toolbar Buttons

Button	Name	Description
	Home	Returns to the MaxiPRO Job Menu.
	Vehicle Swap	Exits the service session of the currently identified test vehicle and returns to the vehicle menu screen.
	Settings	Opens the settings screen. See Settings on page 77 for details.
	Print	Prints a copy of the displayed data. See Printing Setting on page 79 for details.
	Help	Displays operations instructions or tips.
	Save	Saves the current page. See Data Manager on page 64 for details.
	Data Logging	Records the communication data and ECU information of the test vehicle. See Data Logging on page 114 for details.

➤ **To print data in Diagnostics**

1. Tap the **Diagnostics** application button from the MaxiPRO Job Menu. The **Print** button on the diagnostic toolbar is available throughout the Diagnostics operations.
2. Tap **Print**. A drop-down menu displays. Tap **Print This Page** to print a screen shot copy of the current screen.
3. A temporary file will be created and sent to the connected computer for printing.
4. When the file is transferred successfully, a confirmation message displays.

➤ **To submit Data Logging reports in Diagnostics**

1. Tap the **Diagnostics** application button from the MP808BT Job Menu. The **Data Logging** button on the diagnostic toolbar is available throughout the Diagnostics operations.
2. Tap the **Data Logging** button. The button displays blue during the active recording process.
3. Tap the **Data Logging** button again to end recording. A submission form will display for inputting of the report information.

4. Tap the **Send** button to submit the report form via the Internet. A confirmation message displays when the report has been successful sent.

Status Information Bar

The Status Information Bar at the top of the Main Section displays the following items:

1. Menu Title – displays the menu heading of the Main Section.
2. Voltage Icon – displays the vehicle's voltage status.

Main Section

The Main Section of the screen varies according to the stage of operations. The Main Section can display vehicle identification selections, the main menu, test data, messages, instructions and other diagnostic information.

Functional Buttons

The displayed Functional Buttons vary depending on the stage of operations. Functional Buttons can be used to navigate menus, to save or clear diagnostic data, to exit scanning and to perform a number of other control functions. The use of these buttons will be discussed in detail in the following sections of the corresponding test operations.

Screen Messages

Screen messages appear when additional input is needed before proceeding. There are three main types of on-screen messages: Confirmation, Warning, and Error.

Confirmation Messages

This type of messages usually displays as an "Information" screen, to inform the user that a selected action cannot be reversed or when an action has been initiated and confirmation is needed to continue.

When a user-response is not required to continue, the message displays briefly.

Warning Messages

This type of messages displays a warning that a selected action may result in an irreversible change or loss of data. An example of this type of message is the “Erase Codes” message.

Error Messages

Error messages display when a system or procedural error has occurred. Examples of possible errors include a disconnection or communication interruption.

Making Selections

The Diagnostics application is a menu driven program that presents a series of choices. As a selection is made, the next menu in the series displays. Each selection narrows the focus and leads to the desired test. Tap the screen to make menu selections.

Diagnosis

The Diagnostics application enables a data link to the electronic control system of the test vehicle for vehicle diagnosis. The application performs functional tests, retrieves vehicle diagnostic information such as trouble and event codes and live data from various vehicle control systems such as engine, transmission, ABS.

There are two options available when accessing the Diagnosis section:

1. Auto Scan – starts auto scanning for all the available systems on the vehicle.
2. Control Units – displays a selection menu of all available control units of the test vehicle.

After a selection is made and the tablet establishes communication with the vehicle, the corresponding function menu or selection menu displays.

Auto Scan

The Auto Scan function performs a comprehensive scanning over all the ECUs in the vehicle's ECU to locate systems faults and retrieve DTCs. An example of Auto Scan interface is pictured as below:

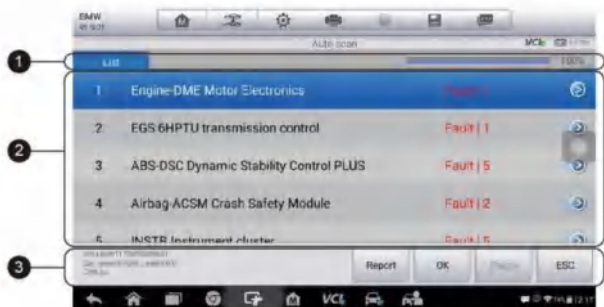

Figure 4-9 Sample Auto Scan Operation Screen

1. Navigation Bar
2. Main Section
3. Functional Buttons

Navigation Bar

List Tab – displays the scanned data in list format.

Progress Bar – indicates the test progress.

Main Section

Column 1 – displays the sequence numbers.

Column 2 – displays the scanned systems.

Column 3 – displays the diagnostic indicators describing test results:

These indicators are defined as follows:

- ❖ **-!-**: Indicates that the scanned system may not support the code reading function, or there is a communication error between the tablet and the control system.
- ❖ **-?-**: Indicates that the vehicle control system has been detected, but the tablet cannot accurately locate it.

- ✧ **Fault(s) | #:** Fault(s) indicates there is/are detected fault code(s) present; “#” indicates the number of the detected faults.
- ✧ **Pass | No Fault:** Indicates the system has passed the scanning process and no fault has been detected.

Column 4 – to perform further diagnosis or testing on a specific system item, tap the  button to the right of that item. A Function Menu screen will display.

Functional Buttons

A brief description of the Auto Scan’s Functional Buttons’ operations are displayed in the table below.

Table 4-3 Functional Buttons

Name	Description
Report	Displays the diagnostic data in the report form.
Quick Erase	Deletes codes. A warning message screen will display to inform you of possible data loss when this function is selected.
OK	Confirms the test result. Continues to the system diagnosis after required system is selected by tapping the item in the Main Section.
Pause	Suspends scanning and it will change to Continue button after tapping.
ESC	Returns to the previous screen or exits Auto Scan.

Control Units

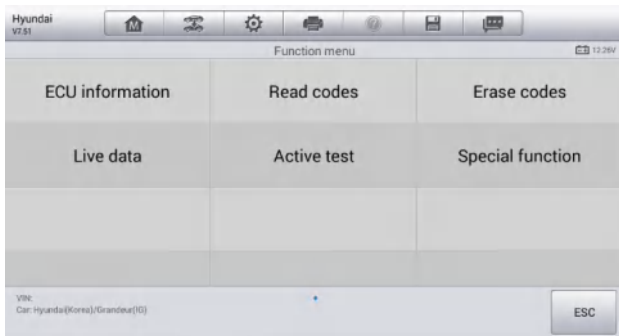

Figure 4-10 Sample Function Menu

Manually locate a required control system for testing through a series of choices. Follow the menu driven procedures and make proper selections; the application guides the user to the proper diagnostic function menu based on selections.

The Function Menu options vary slightly for different vehicles. The function menu may include:

- ECU Information – provides the retrieved ECU information in detail. An information screen opens upon selection.
- Read Codes – displays detailed information of DTC records retrieved from the test vehicle's ECU.
- Erase Codes – erases DTC records and other data from the test vehicle's ECU.
- Live Data – retrieves and displays live data and parameters from the test vehicle's ECU.

NOTE

Toolbar functions such as saving and printing of test results can be performed throughout diagnostic testing. Data logging and access to help information are also available.

➤ **To perform a diagnostic function**

1. Establish communication with the test vehicle.
2. Identify the test vehicle by selecting from the menu options.
3. Select the **Diagnosis** section.

4. Locate the required system for testing by **Auto Scan** or through menu driven selections in **Control Units**.
5. Select the desired diagnostic function from the **Function Menu**.

ECU Information

This function retrieves and displays the specific information for the tested control unit, including unit type, version numbers and other specifications.

The sample ECU Information screen displays as below:

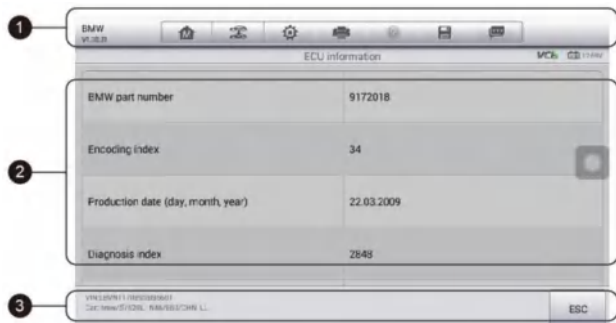

Figure 4-11 Sample ECU Information Screen

1. Diagnostics Toolbar Buttons – see [Table 4- 2 Diagnostics Toolbar Buttons](#) on page 26 for detailed descriptions of the operations for each button.
2. Main Section – the left column displays the item names; the right column shows the specifications or descriptions.
3. Functional Button – **ESC** (a **Back**) button is available; tap it to exit after viewing.

Read Codes

This function retrieves and displays the DTCs from the vehicle's control system. The Read Codes screen varies for each vehicle being tested. On some vehicles, freeze frame data can also be retrieved for viewing. The sample Read Codes screen displays as below:

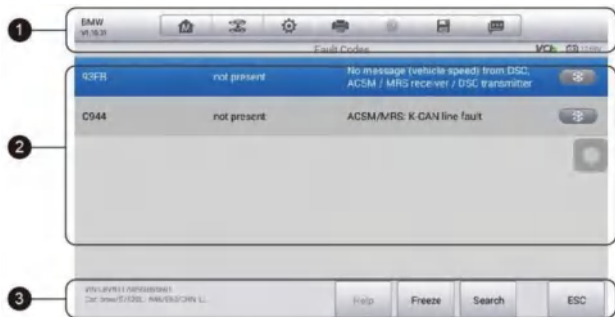

Figure 4-12 Sample Read Codes Screen

1. Diagnostics Toolbar Buttons – see [Table 4- 2 Diagnostics Toolbar Buttons](#) on page 26 for detailed descriptions of the operations for each button.
2. Main Section
 - Code Column – displays the retrieved codes from the vehicle.
 - Status Column – indicates the status of the retrieved codes.
 - Description Column – detailed descriptions for the retrieved codes.
 - Snowflake Icon – only displays when freeze frame data is available for viewing; selecting this icon will display a data screen, which looks behaves similar to the Read Codes screen.
3. Functional Button
 - Help – tap to view fault code information, including fault description, condition for fault identification and driver information.
 - Freeze Frame – tap to view the freeze frame.
 - Search – tap to search for related fault code information on Google.
 - ESC – tap to return to the previous screen or exit the function.

Erase Codes

After reading the retrieved codes and making appropriate vehicle repairs, use this function to erase vehicle codes.

➤ **To erase codes**

1. Tap **Erase Codes** from the Function Menu.
2. A warning message displays to advise of data loss if this function is completed.
 - a) Tap **Yes** to continue. A confirming screen displays when the operation is successfully done.
 - b) Tap **No** to exit.
3. Tap **ESC** on the confirming screen to exit Erase Codes.
4. Perform the Read Codes function again to check if codes have been erased successfully.

Live Data

When this function is selected, the screen displays the data list for the selected module. The items available for any control module vary by vehicle. The parameters display in the order that they are transmitted by the ECM, so expect variation between vehicles.

Gesture scrolling allows for quick movement through data list. Using one or two fingers, simply swipe the screen up or down to locate the data you want. The figure below shows a typical Live Data screen:

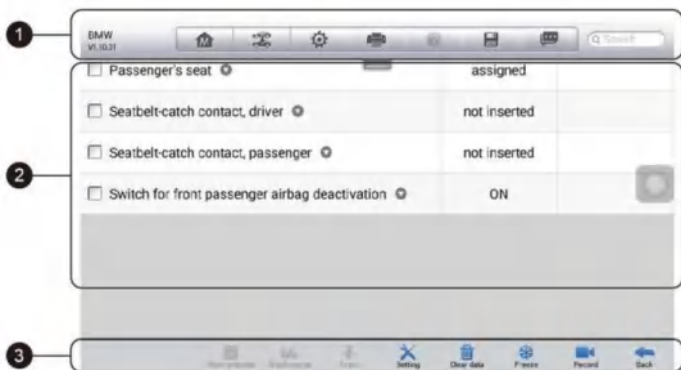

Figure 4-13 Sample Live Data Screen

1. Diagnostics Toolbar Buttons – tap the drop-down button at the top center of the screen and the toolbar buttons will display. See on [Table](#)

[4- 2 Diagnostics Toolbar Buttons](#) page 26 for detailed descriptions of the operations for each button.

2. Main Section

- Name Column – displays the parameter names.
 - a) Check Box – tap the check box on the left side of the parameter name to make item selection. Tap the check box again to deselect the item.
 - b) Drop-down Button – tap the drop-down button on the right side of the parameter name to open a sub menu, providing data display mode options.
- Value Column – displays the values of the parameter items.
- Unit Column – displays the unit for the parameters.
 - To change the unit mode, tap the **Setting** button on the top toolbar and select a required mode. See [Unit](#) on page [77](#) for more information.

Display Mode

There are four types of display modes available for data viewing. Select the proper mode for the diagnostic purpose.

Tap the drop-down button on the right side of the parameter name to open a sub menu. There are four buttons to configure the data display mode, and one Help button on the right for access to additional information.

Each parameter item displays the selected mode independently.

- 1) Analog Gauge Mode – displays the parameters in the form of an analog meter graph.
- 2) Text Mode – this is the default mode which displays the parameters text, displaying in list format.

 **NOTE**

Status parameters, such as a switch reading, can primarily be viewed in text form such as ON, OFF, ACTIVE, and ABORT. Whereas, value parameter, such as a sensor reading, can be displayed in text mode and additional graph modes.

3) Waveform Graph Mode – displays the parameters in waveform graphs.

When this mode is selected, three control buttons display on the right side of the parameter item for manipulation of display status.

- Text Button – resumes Text Display Mode.
- Scale Button – changes the scale values that are displayed below the waveform graph. There are four scales available: x1, x2, x4 and x8.
- Zoom-in Button – tap once to display the selected data graph in full screen.

- ◇ Edit Button – tap this button to open an edit window, on which you can set the waveform color and the line thickness displayed for the selected parameter item.

- ◇ Scale Button - changes the scale values, which are displayed below the waveform graph. There are four scales available: x1, x2, x4 and x8.

- ◇ Zoom-out Button – exits full screen display.

4) Digital Gauge Mode – displays the parameters in form of a digital gauge graph.

Full Screen Display – this option is only available in the waveform graph mode, and primarily in Graph Merge status for data comparison. Under this mode, there are three control buttons available on the top right side of the screen.

➤ **To edit the waveform color and line thickness in a data graph**

1. Select one to three parameter items to display in Waveform Graph mode.
2. Tap the **Zoom-in Button** on the right to display the data graph in full screen.
3. Select a parameter item on the left column.

4. Select a desired sample color from the middle column.
 5. Select a desired sample line thickness from the right column.
 6. Repeat step 3-5 to edit the waveform for each parameter item.
 7. Tap **Done** to save the setting and exit, or tap **Cancel** to exit without saving.
3. Functional Buttons

The operations of available functional buttons on Live Data screen are described below:

Back – returns to the previous screen or exits the function.

Record – starts recording the retrieved live data; the recorded data is then stored as a video clip in the Data Manager application for future review. This function can be triggered automatically at preset threshold value or values may be set manually. The triggering mode and record duration can be configured in the Setting mode of Live Data.

Freeze Frame – displays the retrieved data in freeze frame mode.

- Previous Frame – displays previous frame of the freeze data.
- Next Frame – advances to the next frame in the freeze data.

Clear Data – clears all previously retrieved parameter values at a cutting point.

To Top – moves a selected data item to the top of the list.

Graph Merge – tap this button to merge selected data graphs (for Waveform Graph Mode only). This function is useful for comparison between different parameters.

 **NOTE**

In this mode, Graph Merge can only display up to three parameter items.

- To cancel Graph Merge mode, tap the drop-down button on the right side of the parameter name, and select a data display mode.

Show – tap this option to switch between the two options; one displays the selected parameter items, the other displays all the available items.

Setting – tap this button to access setting menu to set the trigger mode, recording duration and threshold values for data recording, and define other control settings.

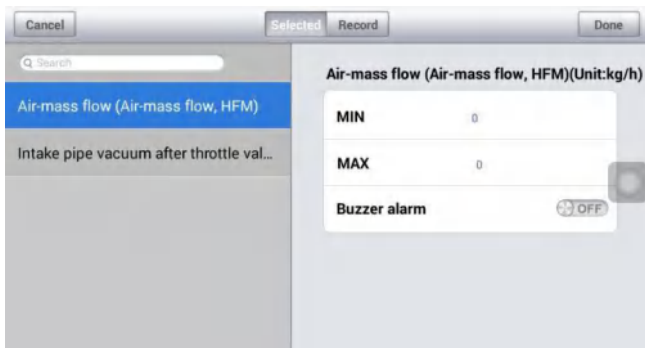

Figure 4-14 Sample Setting Mode in Live Data

There are four navigation buttons on top of the **Setting** mode screen.

- **Selected Button** – displays the configuration screen to set the threshold values, an upper limit and a lower limit, for triggering the buzzer alarm. This function is only applied to the Waveform Graph display mode.
 - a) **MIN** – tap to display virtual keyboard and enter the required lower limit value.
 - b) **MAX** – tap to display virtual keyboard and enter the required upper limit value.
 - c) **Buzzer Alarm** – switches the alarm on and off. The alarm function makes a beep sound as a reminder whenever the data reading reaches the preset minimum or maximum point.

➤ **To set threshold limits for the parameter values**

1. Tap the **Setting** functional button at the bottom of the Live Data screen.
2. Tap the **Selected** navigation button.
3. Select a parameter item on the left column, or enter the item name in the Search bar.
4. Tap on the right side of the **MIN** button, and enter the required minimum value.
5. Tap on the right side of the **MAX** button, and enter the required maximum value.
6. Tap the **ON/OFF** button on the right side of the Buzzer Alarm button to turn it on or off.

7. Tap **Done** to save the setting and return to the Live Data screen; or tap **Cancel** to exit without saving.

If the threshold limits are successfully set, two horizontal lines will display on each of the data graphs (when Waveform Graph Mode is applied) to indicate the alarm point. The threshold lines are displayed in different colors from the waveform of the parameters.

● **Record Button** – displays the configuration screen for Record Setting, to set the trigger type, duration and trigger point for the data recording function.

a) **Trigger Type** – sets the trigger mode for data recording, Manual and Auto. There are four options available:

- 1) **Manual** – manually starts and stops data recording.
- 2) **DTC** – auto triggers data recording when any DTC is detected.
- 3) **DTC Check Mode** – auto triggers data recording when certain pre-selected DTC types are detected.
- 4) **Parameter** – auto triggers data recording when any parameter value reaches the preset threshold.

b) **Duration** – sets the recording time (for Auto trigger mode only).

c) **Trigger Point** – reserves a relative percentage of a record length before the data recording start point for reference (for Auto trigger mode only).

➤ **To perform setting for live data record**

1. Tap the **Setting** functional button at the bottom of the Live Data screen.
2. Tap the **Record** navigation button.
3. Tap the ⊖ button on the right of **Trigger Type** bar and select the required trigger mode.
4. Tap the ⊖ button on the right of **Duration** bar and select a length of time.
5. Tap the ⊖ button on the right of **Trigger Point** bar and select a relative percentage of a record length to be reserved before the data recording start point.

6. Tap **Done** to save the setting and return to the Live Data screen; or tap **Cancel** to cancel without saving and exit Setting.

- **Done** Button - confirms and saves the setting, and returns to the Live Data screen.
- **Cancel** Button – cancels the setting operation, and returns to the Live Data screen.

Generic OBD II Operations

This option presents a quick way to check for DTCs, isolate the cause of an illuminated malfunction indicator lamp (MIL), check monitor status prior to emissions certification testing, verify repairs, and perform a number of other services that are emissions-related. The OBD direct access option is also used for testing OBD II/EOBD compliant vehicles that are not included in the Diagnostics database.

The diagnostics toolbar buttons at the top of the screen function the same as those available for specific vehicle diagnostics. See [Table 4- 2 Diagnostics Toolbar Buttons](#) on page 26 for details.

General Procedure

➤ To access the OBD II/EOBD diagnostics functions

1. Tap the **Diagnostics** application button from the MaxiPRO Job Menu. The Vehicle Menu displays.
2. Tap the **EOBD** button. There are two options to establish communication with the vehicle.
 - Auto Scan – when this option is selected, the diagnostic tool attempts to establish communication using each protocol in order to determine the one from which the vehicle is broadcasting.
 - Protocol – when this option is selected, the screen opens a sub menu listing various protocols. A communication protocol is a standardized way of data communication between an ECM and a diagnostic tool. Global OBD may use several different communication protocols.

3. Select a specific protocol under the **Protocol** option. Wait for the OBD II Diagnostic Menu to display.

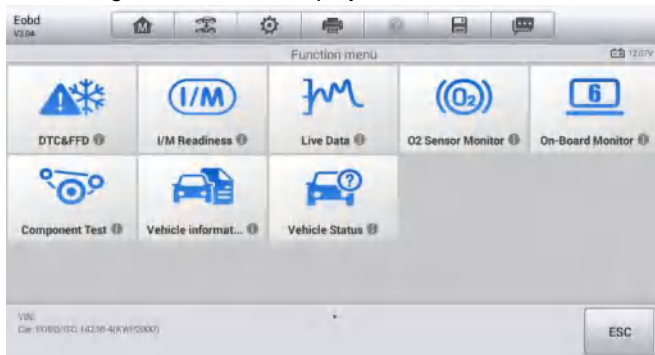

Figure 4-15 Sample OBD II Diagnostic Menu

NOTE

Tapping the button displayed beside the function name opens a bubble with additional function information.

4. Select a function option to continue.

- **DTC & FFD**
- **I/M Readiness**
- **Live Data**
- **On-Board Monitor**
- **Component Test**
- **Vehicle Information**
- **Vehicle Status**

NOTE

Not all functions are supported by all vehicle.

Function Descriptions

This section describes the various functions of each diagnostic option:

DTC & FFD

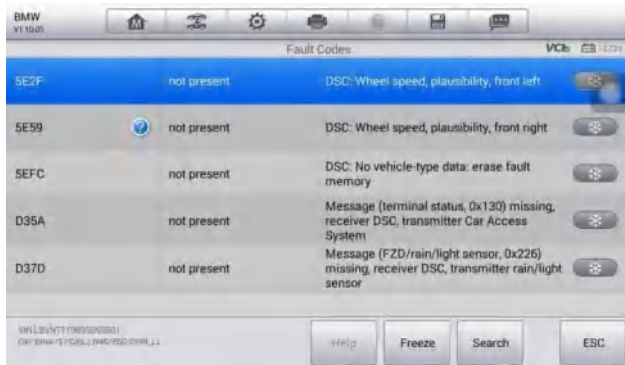

Figure 4-16 Sample DTC & FFD Screen

When this function is selected, the screen displays a list of Stored and Pending Codes. A snowflake button will display on the right side of the DTC item when the Freeze Frame data is available for viewing. Tap **Clear DTC** to erase codes.

●Stored Codes

Stored codes are the current emission-related DTCs from the ECM of the vehicle. OBD II/EOBD Codes have a priority according to their emission severity, with higher priority codes overwriting lower priority codes. The priority of the code determines the illumination of the MIL and the codes erase procedure. Manufacturers rank codes differently, so expect to see differences between makes.

●Pending Codes

These are codes that were generated during the last drive cycle, but before the DTC actually sets, two or more consecutive drive cycles are needed. The intended use of this service is to assist the service technician after a vehicle repair and after clearing diagnostic information, by reporting test results after a driving cycle.

- a) If a test failed during the drive cycle, the DTC associated with that test is reported. If the pending fault does not occur again within 40 to 80 warm-up cycles, the fault is automatically cleared from memory.
- b) Test results reported by this service do not necessarily indicate a faulty component or system. If test results indicate another failure after additional driving, then a DTC is set to indicate a faulty component or system, and the MIL is illuminated.

●Freeze Frame

Typically, the stored frame is the last DTC that occurred. Certain DTCs that have a greater impact on vehicle emission, have a higher priority. In these cases, the top prioritized DTC is the one for which the freeze frame records are retained. Freeze frame data includes a “snapshot” of critical parameter values at the time the DTC is set.

●Clear DTC

This option is used to clear all emission related diagnostic data such as DTCs, freeze frame data and manufacturer-specific enhanced data from the vehicle’s ECM.

A confirmation screen displays when the clear codes option is selected to prevent accidental loss of data. Select **Yes** to continue or **No** to exit.

I/M Readiness

This function is used to check the readiness of the monitoring system. It is an excellent function to use prior to having a vehicle inspected for state emissions compliance. Select I/M Readiness to display a sub menu with two choices:

- Since DTCs Cleared** – displays the status of monitors since the last time the DTCs are erased.
- This Driving Cycle** – displays the status of monitors since the beginning of the current drive cycle.

Live Data

This function displays the real time PID data from ECU. Displayed data includes analog inputs and outputs, digital inputs and outputs, and system status information broadcast on the vehicle data stream.

Live data can be displayed in various modes, see [Live Data](#) on page 34 for detailed information.

On-Board Monitor

Use this option to view the results of On-Board Monitor tests. The tests are useful after servicing or after erasing a vehicle's control module memory.

Component Test

This service enables bi-directional control of the ECM so that the diagnostic tool is able to transmit control commands to operate the vehicle systems. This function is useful in determining whether the ECM responds to a command well.

Vehicle Information

The option displays the vehicle identification number (VIN), the calibration identification, and the calibration verification number (CVN), and other information of the test vehicle.

Vehicle Status

This option is used to check the current condition of the vehicle, including communication protocols of OBD II modules, retrieved codes amount, status of the Malfunction Indicator Light (MIL), and other additional information.

Exiting Diagnostics

The Diagnostics application remains open as long as there is an active communication with the vehicle. You must exit the diagnostics operation to stop all communications with the vehicle before closing the Diagnostics application.

NOTE

Damage to the vehicle electronic control module (ECM) may occur if communication is disrupted. Make sure all connections, such as USB cable and wireless connection, are properly connected at all times during testing. Exit all tests before disconnecting the test connection or powering down the tool.

To exit the Diagnostics application

1. From an active diagnostic screen, tap the **Back** or **ESC** functional button to exit a diagnostic session step-by-step.
2. Or tap the **Vehicle Swap** button on the diagnostics toolbar to return to the Vehicle Menu screen.
3. From the Vehicle Menu screen, tap the **Home** button on the top toolbar; or tap the **Back** button on the navigation bar at the bottom of the screen.
4. Or tap the **Home** button on the diagnostics toolbar to exit the application directly and go back to the MaxiPRO Job Menu.

Now, the Diagnostics application is no longer communicating with the vehicle and it is safe to open other MaxiPRO applications, or exit the MaxiPRO Diagnostic System and return to the Android System's Home screen.

5 Service

The Service section is specially designed to provide quick access to the vehicle systems for various scheduled service and maintenance tasks. The typical service operation screen is a series of menu driven executive commands. Follow on-screen instructions to select appropriate execution options, enter correct values or data, and perform necessary actions. The application will display detailed instructions to complete selected service operations.

The most commonly performed service functions include:

- Oil Reset Service
- EPB Service
- BMS Service
- SAS Service
- DPF Service

After entering each special function, the screen will display two application choices: **Diagnosis** and **Hot Functions**. **Diagnosis** enables the reading and clearing of codes which are sometimes necessary after completing certain special functions. **Hot Functions** consists of sub functions of the selected special function.

Oil Reset Service

Perform reset for the Engine Oil Life system, which calculates an optimal oil life change interval depending on the vehicle driving conditions and climate. The Oil Life Reminder must be reset each time the oil is changed, so the system can calculate when the next oil change is required.



IMPORTANT

Always reset the engine oil life to 100% after every oil change.

NOTE

All required work must be carried out before the service indicators are reset. Failure to do so may result in incorrect service values and cause DTCs to be stored by the relevant control module.

NOTE

For some vehicles, the scan tool can reset additional service lights such as maintenance cycle and service interval. On BMW vehicles for an example, service resets include engine oil, spark plugs, front/rear brakes, coolant, particle filter, brake fluid, micro filter, vehicle inspection, exhaust emission inspection and vehicle check.

All software screens shown in this manual are examples, actual test screens may vary for each vehicle being tested. Observe the menu headings and on-screen instructions to make correct selections.

➤ **To perform oil reset functions**

1. Tap the **Service** application button from the MaxiPRO Job Menu.
2. Tap **Oil Reset** button. The vehicle manufacturer screen displays. Tap **VIN Scan** or the vehicle make to acquire vehicle VIN information and tap **Yes** to confirm. See [Vehicle Identification](#) on page 20 for detail.
3. Tap the desired function in the Oil Reset function list. The list may vary by test vehicle.



Figure 5-1 Sample Oil Function List

4. Follow the step-by-step on-screen instruction to complete the service. Using **CBS vehicle date correction** as an example.

5. Tap **CBS vehicle date correction** on the Oil Reset function list to start the operation. The screen will display the date and time and ask for confirmation. If the displayed date and time are correct, tap **Yes** to confirm. If not, tap **No** and go to the Settings menu to set the correct date and time.

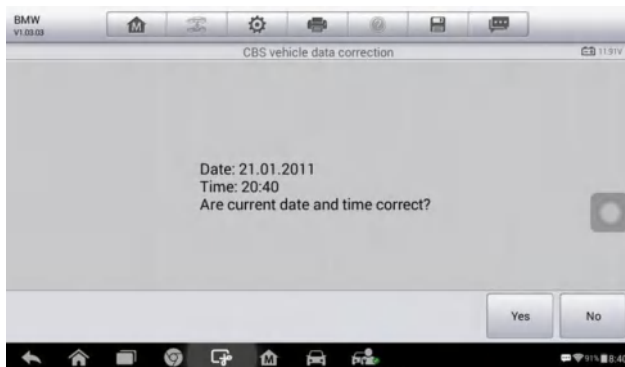

Figure 5-2 Sample Oil Reset Service Screen 1

6. The available items will display in a table of four columns: CBS value, availability, service counter and forecast.
7. Tap on the value you want to reset and then tap the **Correction** button on the right bottom of the screen.

CBS value	availability	service counter	forecast
Engine oil	0 %	0	0 km
Front Brake	16 %	25	19000 km
Rear Brake	20 %	0	205000 km

Figure 5-3 Sample Oil Reset Service Screen 2

8. The tool will display a function list menu as below. Press the corresponding number button to perform the desired function. Tap **ESC** to exit.

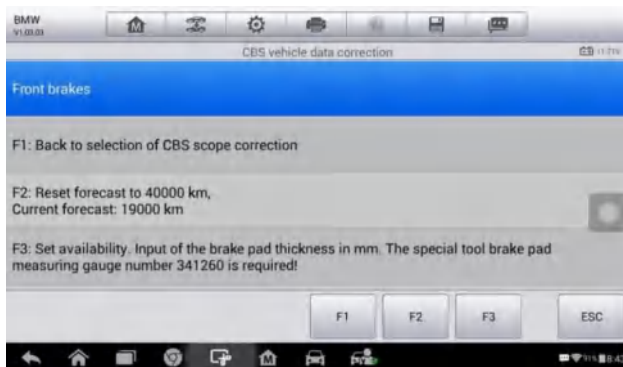

Figure 5-4 Sample Oil Reset Service Screen 3

9. When the reset is done, the screen will display “Service function finished”. Tap Continue to exit.

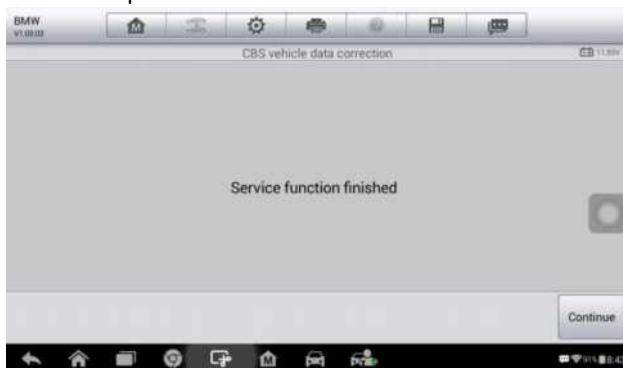

Figure 5-5 Sample Oil Reset Service Screen 4

Electronic Parking Brake (EPB) Service

This function has a multitude of usages to maintain the electronic braking system safely and effectively. The applications include deactivating and activating the brake control system, assisting with brake fluid control, opening and closing brake pads, and setting brakes after disc or pad replacement, etc.

EPB Safety

It may be dangerous to perform Electronic Parking Brake (EPB) system maintenance, so before you begin the service work, please keep these rules in mind.

- ✓ Ensure that you are fully familiar with the braking system and its operation before commencing any work.
- ✓ The EPB control system may be required to be deactivated before carrying out any maintenance/diagnostic work on the brake system. This can be done from the tool menu.
- ✓ Only perform maintenance work when the vehicle is stationary and on level ground.
- ✓ Ensure that the EPB control system is reactivated after the maintenance work has been completed.

NOTE

Autel accepts no responsibility for any accident or injury arising from the maintenance of the Electronic Parking Brake system.

➤ To perform EPB functions

1. Tap the **Service** application button from the MaxiPRO Job Menu.
2. Tap **EPB** button. The vehicle manufacturer selection screen will display. Tap **VIN Scan** or the vehicle manufacturer to acquire vehicle VIN information and tap **Yes** to confirm. See [Vehicle Identification](#) on page 20 for detail.
3. Tap the desired service in the EPB function list. The list may vary for different vehicles being tested.

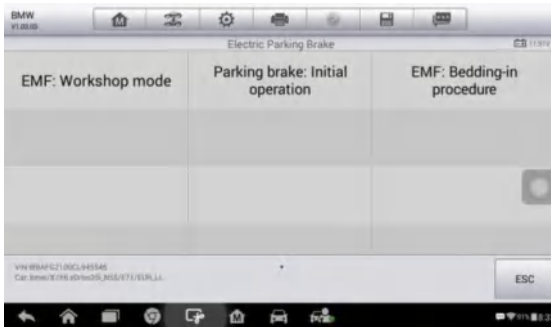

Figure 5-6 Sample EPB Function List

4. Follow the step-by-step on-screen instruction to complete the service. Using **Parking brake: Initial operation** as an example.
5. Press **ESC** button to exit.

Parking brake: Initial operation

This service function would start up the parking brake. It must be conducted after the following operation:

- Terminal 15 OFF
- Terminal 15 ON
- Press brake pedal forcefully
- Keep brake pedal pressed
- Apply parking brake (pull button)
- Release parking brake button (press)

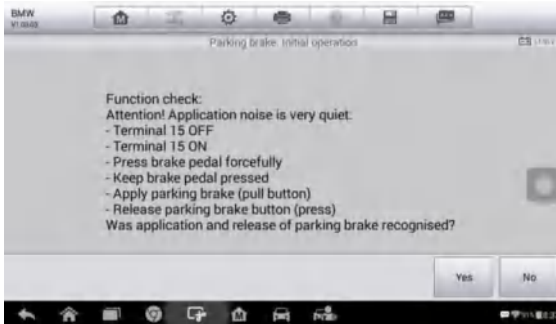
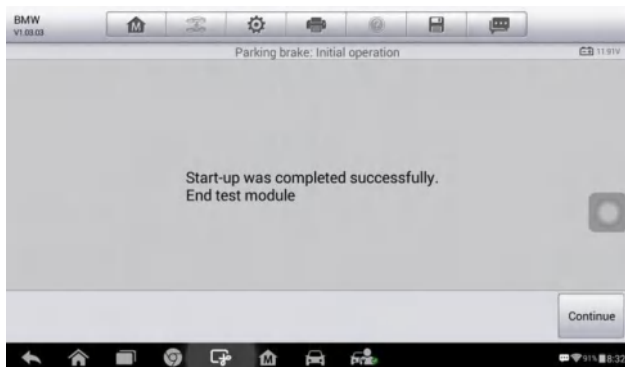

Figure 5-7 Sample Parking brake: Initial operation

Screen 1

- 1) Tap **Yes** to proceed with this service function or the **No** button at the bottom left to exit.
- 2) When the operation is successfully completed, a “Completed successfully” message will display on the screen, press **Continue** to exit.



**Figure 5-8 Sample Parking brake: Initial operation
Screen 2**

Battery Management System (BMS) Service

The Battery Management System (BMS) allows the scan tool to evaluate the battery charge state, monitor the close-circuit current, register the battery replacement, and activate the rest state of the vehicle.

NOTE

1. This function is not supported by all vehicles. The screens shown in this section are examples.
 2. The sub functions and actual test screens of the BMS vary by vehicle, please follow the on-screen instructions to make correct option selection.
-

The vehicle may use either a sealed lead-acid battery or an AGM (Absorbed Glass Mat) battery. Lead acid battery contains liquid sulphuric acid and can spill when overturned. AGM battery (known as VRLA battery, valve regulated lead acid) also contains sulphuric acid, but the acid is contained in glass mats between terminal plates.

It is recommended that the replacement aftermarket battery has the same specifications, such as capacity and type, as the existing battery. If the original battery is replaced with a different type of battery (e.g. a lead-acid battery is replaced with an AGM battery) or a battery with a different capacity (mAh), the vehicle may require reprogramming of the new battery type, in addition to performing the battery reset. Consult the vehicle manual for additional vehicle-specific information.

Register Battery Replacement

This option displays the mileage reading when the last battery was replaced, registers the battery replacement after replacing a new battery and informing the power management system that a new battery has been installed.

If the battery change is not registered, the power management system will not function properly, which may not provide the battery with enough charging power to operate the vehicle or limit the functionality of vehicle's electrical systems.

Using the **BMW** as an example.

➤ To register the battery exchange

1. Tap the **Service** application button from the MaxiPRO Job Menu.

2. Tap **BMS** button and wait for the vehicle manufacturer screen. You can tap **VIN Scan** or the vehicle make to acquire vehicle VIN information and tap **Yes** to confirm. See [Vehicle Identification](#) on page 20 for detail.
3. Tap **Register battery exchange** in the **Battery** function list. The list may vary by test vehicle.

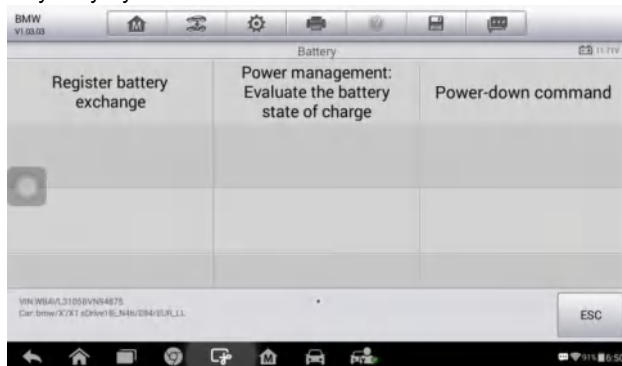

Figure 5-9 Sample BMS Function List

4. Tap on the desired function to complete. In our example, tap **F1 Register battery replacement**.

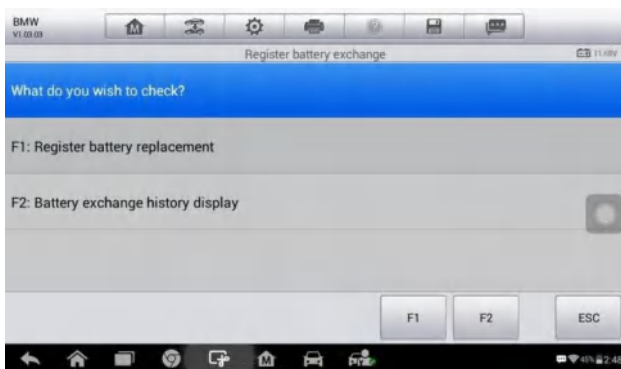

Figure 5-10 Sample BMS Screen 1

5. Read carefully the information on the screen and scroll through list to view all functions.

There are four functions listed:

F1 Enter battery replacement: Same capacity

F2 Enter battery replacement: Higher/lower capacity

F3 Enter battery replacement: Changing from the normal lead-acid battery (white housing) to AGM battery (black housing)

ESC End service function.

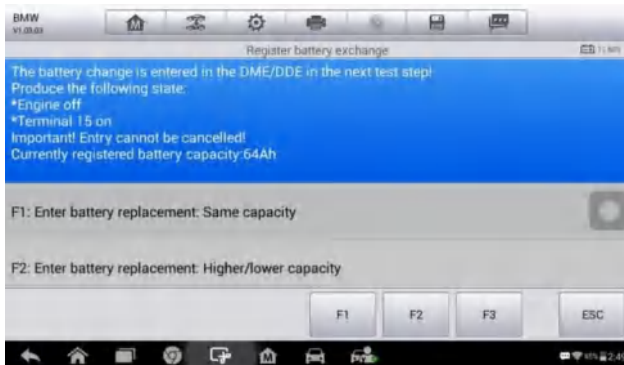

Figure 5-11 Sample BMS Screen 2

Take the second function as an example.

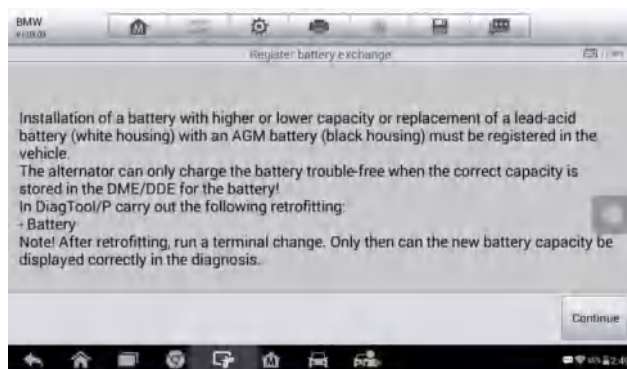

Figure 5-12 Sample BMS Screen 3

6. Read carefully the information on the screen and tap **Continue** to the next screen.
7. Follow the on-screen instructions to input the data matrix code of the newly installed battery which should be on the label of the battery. Tap **OK** to continue.

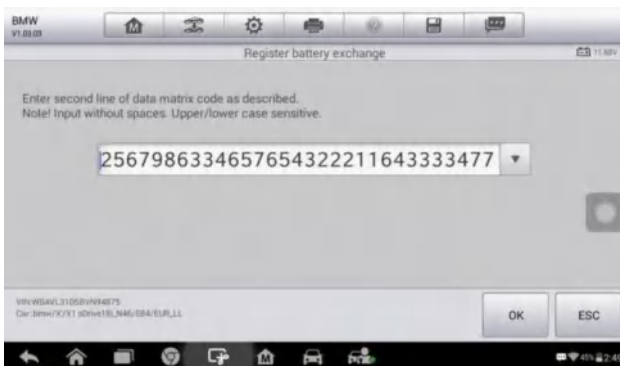

Figure 5-13 Sample BMS Screen 4

8. When the battery exchange is successfully entered, tap Continue to complete the operation.



Figure 5-14 Sample BMS Screen 5

Steering Angle Sensor (SAS) Service

Steering Angle Sensor Calibration permanently stores the current steering wheel position as the straight-ahead position in the steering angle sensor EEPROM. Therefore, the front wheels and the steering wheel must be set exactly to the straight-ahead position before calibration. In addition, the vehicle identification number is also read from the instrument cluster and stored permanently in the steering angle sensor EEPROM. On successful completion of calibration, the steering angle sensor fault memory is automatically cleared.

Calibration must always be carried out after the following operations:

- Steering wheel replacement
 - Steering angle sensor replacement
 - Any maintenance that involves opening the connector hub from the steering angle sensor to the column
 - Any maintenance or repair work on the steering linkage, steering gear or other related mechanism
 - Wheel alignment or wheel track adjustment
 - Accident repairs where damage to the steering angle sensor or assembly, or any part of the steering system may have occurred
-

 **NOTE**

1. AUTEL accepts no responsibility for any accident or injury arising from servicing the SAS system. When interpreting DTCs retrieved from the vehicle, always follow the manufacturer's recommendation for repair.
 2. All software screens shown in this manual are examples, actual test screens may vary for each test vehicle. Pay attention to the menu titles and on-screen instructions to make correct option selections.
 3. Before starting the procedure, make sure the vehicle has ESC button. Look for the button on dash.
-

Using **BMW** as an example.

1. Tap the **Service** application button from the MaxiPRO Job Menu.
2. Tap **SAS** button and wait for the vehicle manufacturer screen. You can tap **VIN Scan** or the vehicle make to acquire vehicle VIN information and tap **Yes** to confirm. See [Vehicle Identification](#) on page 20 for detail.
3. Tap the desired function in the **SAS** function list. The list may vary by test vehicle.



Figure 5-15 Sample SAS Function Menu

Steering Angle Sensor adjustment

This function allows users to perform steering angle sensor calibration and clear records. The function options vary by vehicles.

- 1) Tap **Steering Angle Sensor adjustment** from the SAS function menu to enter the function screen.
- 2) The steering angle must be calibrated after following jobs:
 - Replacement of steering column switch cluster
 - Encoding of DSC control unit
 - Adjustment work on steering geometry
 - Working on steering and/or front axle

Tap **continue** to the next step.

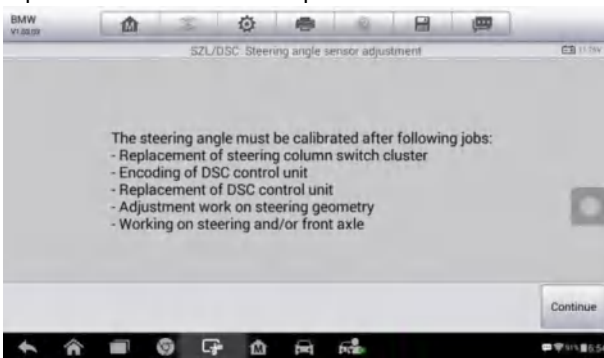

Figure 5-16 Sample SAS Function Screen 1

- 3) The run flat indicator must be additionally initialized after adjusting the steering angle sensor on completion of the following work:
- Encoding of DSC control unit
 - Replacement of DSC control unit
- Tap **continue** to proceed.

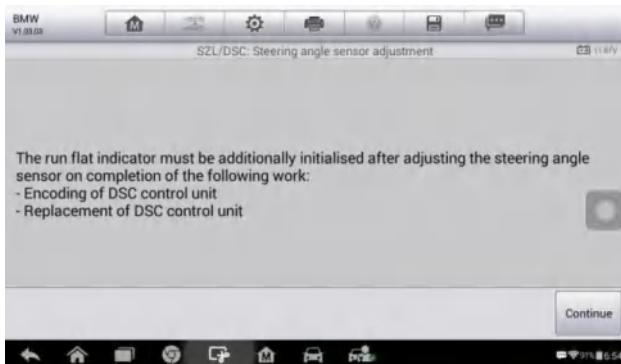

Figure 5-17 Sample SAS Function Screen 2

- 4) Read the complete information carefully and tap **Yes** to the next step, tap **No** to exit.

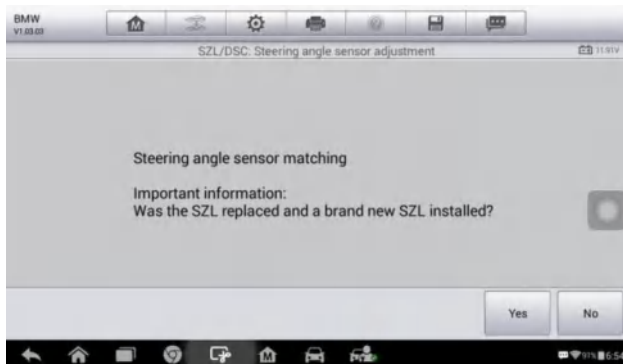

Figure 5-18 Sample SAS Function Screen 3

- 5) Follow the step-by-step on-screen instruction to continue.

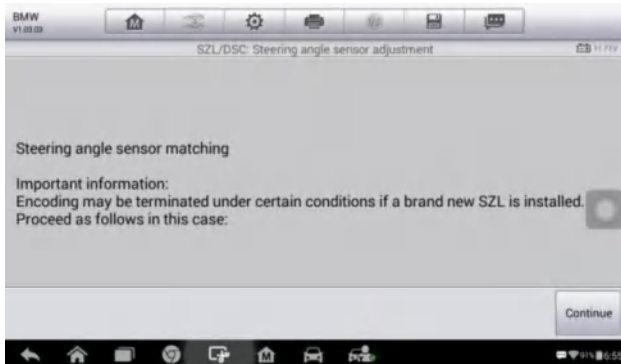

Figure 5-19 Sample SAS Function Screen 4

- 6) Read the complete information carefully and tap **Yes** to end the test module or tap **No** to continue.

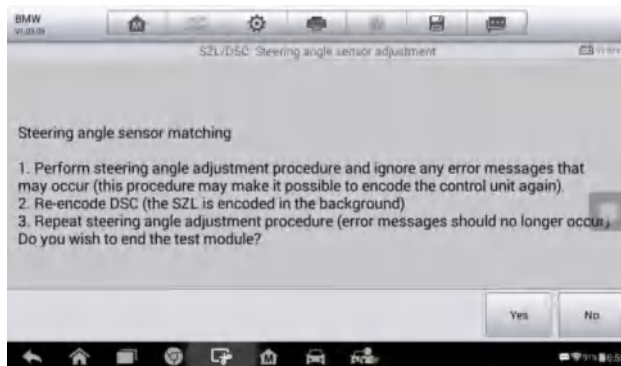

Figure 5-20 Sample SAS Function Screen 5

- 7) Exactly set front wheels to straight-ahead position. The steering wheel must be positioned horizontally. Tap **Continue** to the next step.

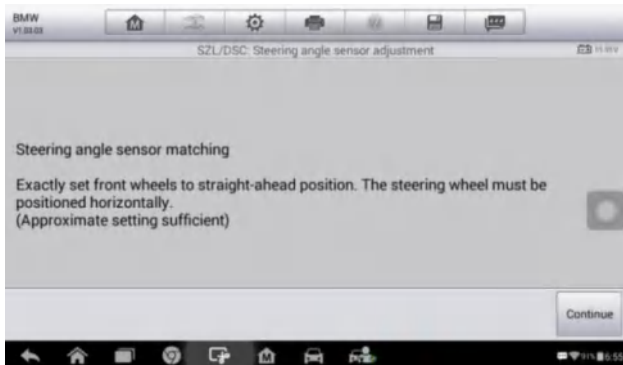

Figure 5-21 Sample SAS Function Screen 6

- 8) Read the attention carefully and tap **Continue** to the next step.

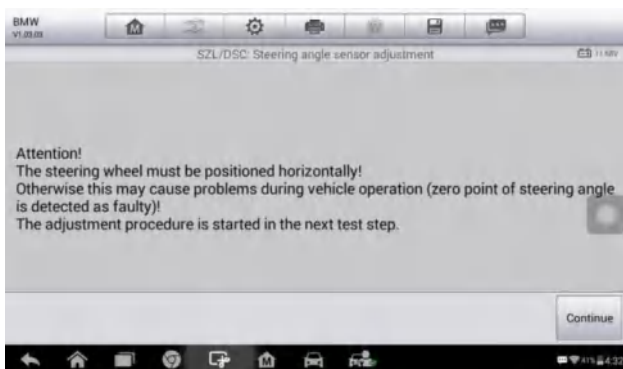

Figure 5-22 Sample SAS Function Screen 7

- 9) The adjustment procedure is started in this step, please wait until the “Adjustment was successful” message displayed. Tap **Continue** to proceed.

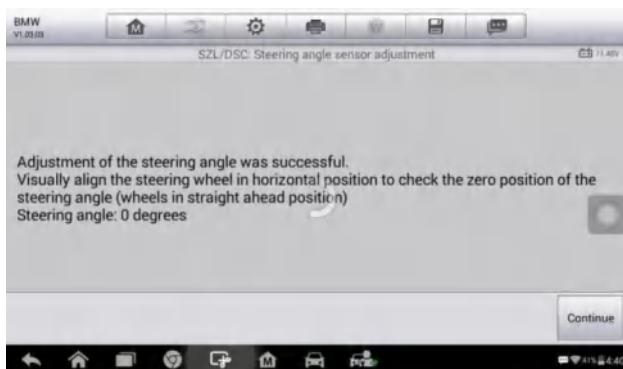

Figure 5-23 Sample SAS Function Screen 8

- 10) Confirm the degrees of the steering angle and then tap **Yes** to continue.

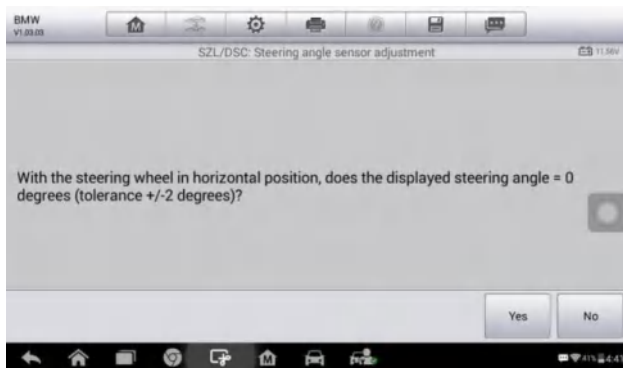

Figure 5-24 Sample SAS Function Screen 9

- 11) Adjustment of the steering angle was carried out correctly. Tap **Continue** to end the test module.

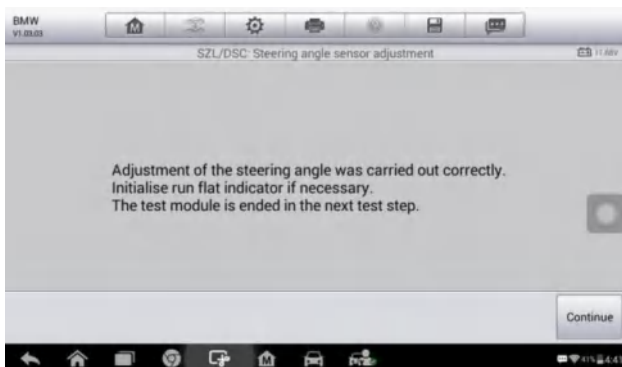

Figure 5-25 Sample SAS Function Screen 10

Diesel Particle Filter (DPF) Service

The Diesel Particle Filter (DPF) function manages DPF regeneration, DPF component replacement teach-in and DPF teach-in after replacing the engine control unit.

The ECM monitors driving style and selects a suitable time to employ regeneration. Cars driven a lot at idling speed and low load will attempt to regenerate earlier than cars driven more with high load and speed. In order for regeneration to take place, a prolonged high exhaust temperature must be obtained.

In the event of the car being driven in such a way that regeneration is not possible, i.e., frequent short journeys, a diagnostic trouble code will eventually be registered in addition to the DPF light and “Check Engine” indicators displaying. A service regeneration can be requested in the workshop, using the diagnostic tool.

Before performing a forced DPF regeneration using the tool, check the following items:

- The fuel light is not on.
- No DPF-relevant faults are stored in system.
- The vehicle has the correct spec engine oil.
- The oil for diesel is not contaminated.

! IMPORTANT

Before diagnosing a problem vehicle and attempting to perform an emergency regeneration, it is important to obtain a full diagnostic log and read out relevant measured value blocks.

🔧 NOTE

1. The DPF will not regenerate if the engine management light is on, or there is a faulty EGR valve.
2. The ECU must be re-adapted when replacing the DPF and when topping up the fuel additive Eolys.
3. If the vehicle needs to be driven in order to perform a DPF service, a second person is needed for the function. One person should drive

the vehicle while the other person observes the screen on the Tool. Do not attempt to drive and observe the scan tool at the same time. This is dangerous and puts your life and the lives of other motors and pedestrians at risk.

1. Tap the **Service** application button from the MaxiPRO Job Menu.
2. **DPF** button and wait for the vehicle manufacturer screen. You can tap **VIN Scan** or the vehicle make to acquire vehicle VIN information and tap **Yes** to confirm. See [Vehicle Identification](#) on page 20 for detail.
3. Tap the desired function in the **DPF** function list. The list may vary by test vehicle.

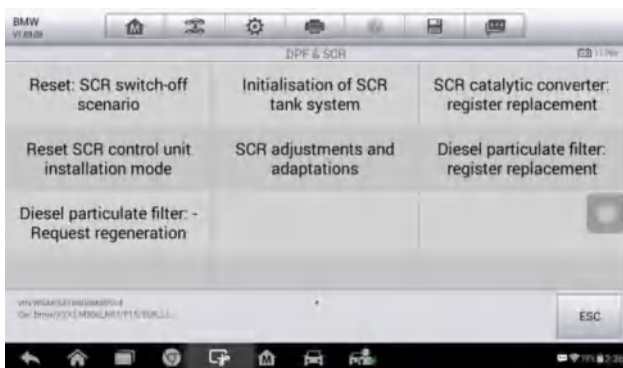

Figure 5-26 Sample DPF Service Function Menu

4. Follow the step-by-step on-screen instruction to complete the service. Using **Diesel particulate filter: -Request regeneration** as an example.

Diesel particulate filter: -Request regeneration

1. Tap **Diesel particulate filter: -Request regeneration** from the service functions menu.

2. Read the Note carefully and tap **Continue** to the next step.

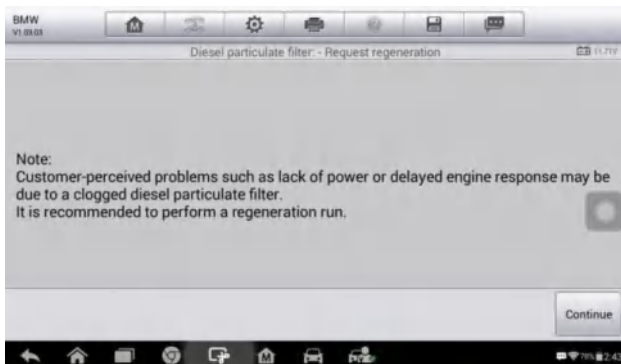

Figure 5-27 Sample DPF Function Screen 1

3. A series of instruction screens display for users to perform the **Request regeneration** step by step.

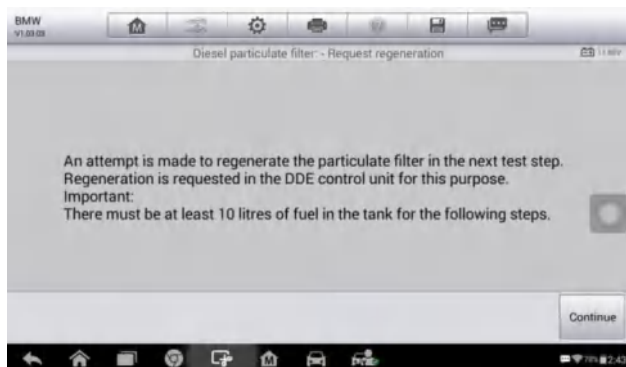

Figure 5-28 Sample DPF Function Screen 2

4. The particulate filter can only be regenerated by driving the vehicle and it requires approximately 45 minutes. Tap **Continue** to the next step.



Figure 5-29 Sample DPF Function Screen 3

5. The tool will display a function list menu as below. Press the corresponding number button to perform the desired function. Tap **F1** to perform **Request regeneration** or tap **ESC** to end this procedure.

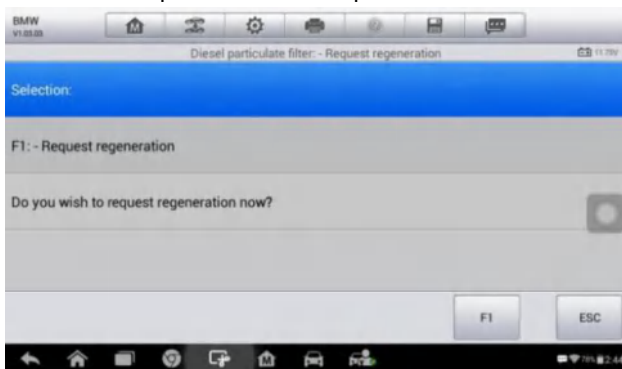

Figure 5-30 Sample DPF Function Screen 4

6. When performed successfully, a “Regeneration was successfully requested” message will display on the screen. Tap **Continue** to the next step.



Figure 5-31 Sample DPF Function Screen 5

7. Switch off the ignition and tap **Continue** to the next step.



Figure 5-32 Sample DPF Function Screen 6

8. Turn on ignition again and start engine. Read the notes on the screen carefully and then tap **Continue** to the next step.

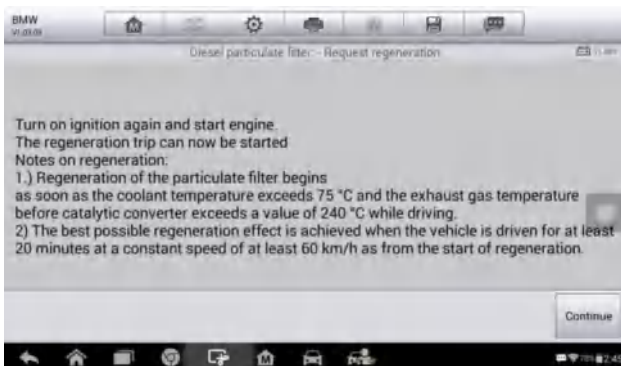

Figure 5-33 Sample DPF Function Screen 7

9. Read the information carefully and then tap **Continue** to the next step.

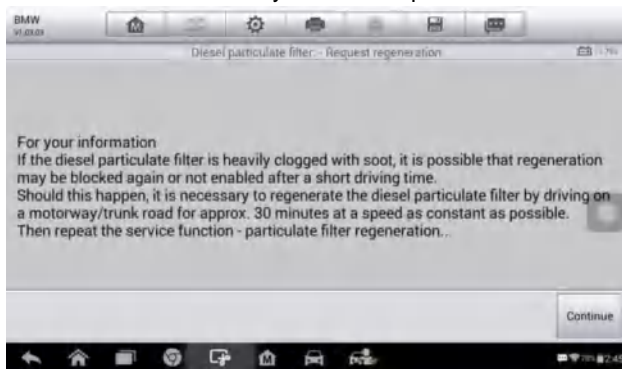

Figure 5-34 Sample DPF Function Screen 8

10. The current regeneration status is shown in the following step. Read the information carefully and then tap **Continue** to the next step.

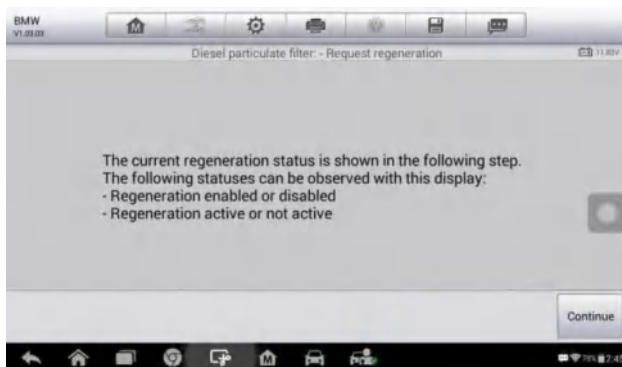

Figure 5-35 Sample DPF Function Screen 9

11. A series of instruction screens display for users to perform the particle filter regeneration step by step. Follow the onscreen instructions and tap **Continue** button until the tool displays the regeneration status as below.

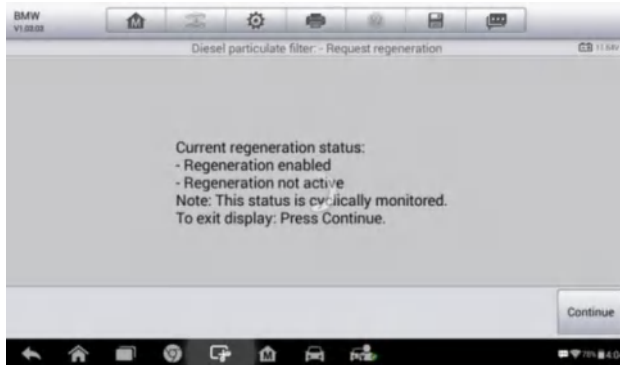

Figure 5-36 Sample DPF Function Screen 10

12. Tap **F1** to continue display the status of current regeneration or tap **ESC** to exit.



Figure 5-37 Sample DPF Function Screen 10

6 Data Manager

The **Data Manager** application is used to store, print, and review the saved files. Most operations are controlled through the toolbar.

Selecting the Data Manager application opens the file system menu. Different file types are sorted separately under different options, there are five types of information files to be viewed or played back.

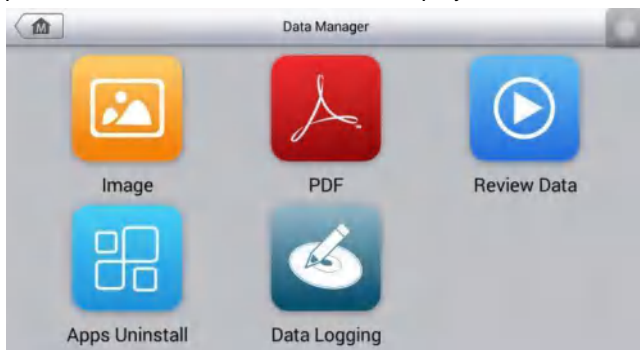

Figure 6-1 Sample Data Manager Main Screen

Operations

Data Manager Operations are based on toolbar controls. Details are explained in the following sections.

Image Files

The Image section contains all captured screenshot images.



Figure 6-2 Sample Image Screen

1. **Toolbar Buttons** – used to edit, print and delete the image files. See the following table for detailed information.
2. **Main Section** – displays the stored images.

Table 6-1 Toolbar Buttons in Image Screen

Button	Name	Description
	Back	Returns to the previous screen.
	Enter Edit	Tap this button to display the editing toolbar. Print, delete or view image information.
	Cancel	Tap this button to close the editing toolbar or cancel file search.
	Search	Quickly locates the image file by entering the vehicle name, test path, file name or file info.
	Info	Tap this button to display the details.
	Print	Tap this button to print the selected image.
	Delete	Tap this button to delete the selected image.

➤ **To edit image information**

1. Select **Data Manager** application from the MaxiPRO Job Menu.
2. Select **Image** to access the image database.
3. Select an image to display in full screen.
4. Tap the screen to display the editing toolbar.
5. Tap the **Info** button to display image information.
6. Tap the **Edit** button on the top right corner of the window. The editing screen displays.
7. Edit the image information by entering the new file name, and file information.
8. Tap **Done** to save the information and exit, or tap **Cancel** to exit without saving.

 **NOTE**

The printer driver program must be installed in order for the tablet's Wi-Fi printer capabilities can be used.

➤ **To install the printer driver program**

1. Please download the **Maxi PC Suite** from www.autel.com > Support > Downloads > Autel Update Tools, and install to your windows-PC. The Maxi PC Suite consists of Autel Printer, MaxiSys Pinter and PC Suite.
2. Double click on **Setup.exe** item.
3. Select the installation language and the printer driver installation wizard will load momentarily.
4. Follow the wizard instructions on the screen and click **Next** to continue.
5. Click on **Install** and the printer driver program will be installed onto the computer.
6. Click on **Finish** to complete the installation procedure.

➤ **To delete selected images**

1. Select **Data Manager** application from the MaxiPRO Job Menu.
2. Select **Image** to access the JPG database.
3. Tap the **Enter Edit** button to display the editing toolbar.

4. Select the images that need to be deleted by tapping the thumbnail images, the selected thumbnail displays a tick icon at the bottom right corner.
5. Tap the **Delete** button, and then **Delete Selected**, then the selected images will be deleted.

PDF Files

The PDF section stores and displays all saved data PDF files. Select a PDF file from the database to display.

The standard Adobe Reader application is used for file viewing and editing, please refer to the associated Adobe Reader manual for detailed instructions.

Review Data

The Review Data section allows playback of the recorded data frames of live data streams.

On the Review Data main screen, select a record file to playback.



Figure 6-3 Sample Data Playback Screen

1. Drop-down Toolbar – tap the button at the top center of the screen to open the Drop-down Toolbar.
2. Main Section – displays the recorded data frames.
3. Navigation Toolbar – controls data playback.

Use the Navigation Toolbar buttons to playback the record data from frame to frame.

Tap **Back** to exit data playback.

Apps Uninstall

This section manages the firmware applications installed on the MaxiPRO Diagnostics System. Select this section to open a management screen, on which you all the available vehicle diagnostic application can be reviewed.

Tap on the vehicle manufacturer icon that you wish to delete. The selected icon will display a blue check at the upper right corner. Tap the **Delete** button on the top bar to delete the firmware from the system database.

Data Logging

The Data Logging section allows you to launch Support platform directly to view all records of all sent or unsent (saved) data loggings on the diagnostic system. For more details, please refer to [Data Logging](#) on Page 114.

7 Settings

Tap the **Settings** button to adjust the default setting and view information about the MaxiPRO system. There are seven options available for the MaxiPRO system settings:

- **Unit**
- **Language**
- **Printing Setting**
- **Notification Center**
- **Auto Update**
- **About**
- **System Settings**

This section describes the procedures to adjust the device's system settings.

Unit

This option allows you to adjust the measurement unit for the diagnostic system.

➤ **To adjust the unit setting**

1. Tap the **Settings** application on the MaxiPRO Job Menu.
2. Tap the **Unit** option on the left column.
3. Select the appropriate measurement unit, Metric or English. A tick icon will display to the right of the selected unit.
4. Tap the **Home** button on the top left corner to return to the MaxiPRO Job Menu. Or select another setting option for system setup.



Figure 7-1 Sample Unit Setting Screen

Language

This option allows you to adjust the display language for the MaxiPRO system.

➤ **To adjust the language setting**

1. Tap the **Settings** application on the MaxiPRO Job Menu.
2. Tap the **Language** option on the left column.



Figure 7-2 Sample Language Setting Screen

3. Select the appropriate language. A check will display to the right of the selected language.
4. Tap the **Home** button on the top left corner to return to the MaxiPRO Job Menu, or tap another setting to adjust.

Printing Setting

Configure this option to enable the tablet to print through a specified Wi-Fi network connection.

➤ **To setup the printer connection**

1. Tap the **Settings** application on the MaxiPRO Job Menu.
2. Tap the **Printing Setting** option on the left column.
3. Tap the **Print via Network** item to activate the printing function, which enables the device to send files to the printer through the networked PC via Wi-Fi connection.
4. Tap the **Home** button on the top left corner to return to the MaxiPRO Job Menu, or tap another setting to adjust.

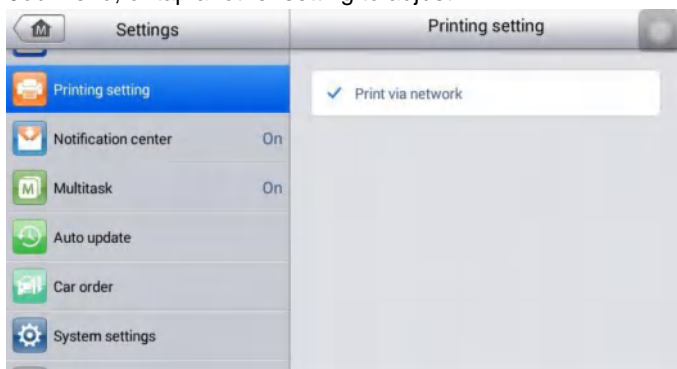

Figure 7-3 Sample Printing Setting Screen

Printing via APP

MP808BT provides the most convenient printing method, printing via APP.

To realize this function, please make sure a Wi-Fi printer is available and then purchase a Wi-Fi printer APP and install it onto your tablet.

By a simple click on the Print button of a saved file on the tablet, the file will be printed automatically.

Printing via PC

If the Wi-Fi printer is not available, you can also use your windows-PC to print the data on the tablet. Follow the instructions below to realize this function.

➤ To install the printer driver program to a computer

1. Download the **Maxi PC Suite** from www.autel.com and install to your windows-PC.
2. Double click on **Setup.exe** item.
3. Select the installation language and the wizard will load momentarily.
4. Follow the instructions on the screen and click **Next** to continue.
5. Click on **Install** and the printer driver program will be installed onto the computer.
6. Click on **Finish** to complete the installation.

NOTE

The MaxiSys Printer runs automatically after the installation. The computer, printer and the tablet must be connected to the same network.

➤ To perform printing through the computer

1. Run the **MaxiSys Printer** program on the computer.
2. Click **Test Print** to make sure the printer is working successfully.
3. Tap the **Print** button on the toolbar. A temporary document will be created and sent to the computer for printing and the received document automatically when the **Auto Print** option is selected.
4. Tap the **Print** button on the toolbar of the tablet. A test document will be sent to the computer.
 - ✧ If the **Auto Print** option in the MaxiSys Printer is selected, the MaxiSys Printer will print the received document automatically.
 - ✧ If the **Auto Print** option is not selected, click **Open PDF File** button to view all the temporary files. Select the file(s) to print and click **Print**.

Notification Center

This option allows you to turn the Notification Center function on or off. The Notification Center function configures the MaxiPRO tablet to receive regular on-line messages from the server for system update notifications or other service information via the Internet. It is highly recommended to keep this function ON all the time, to ensure notifications of updates are received. Internet access is required for receiving on-line messages.

➤ **To enable the Notification Center function**

1. Tap the **Settings** application on the MaxiPRO Job Menu.
2. Tap the **Notification Center** option on the left column.
3. Tap the **ON/OFF** button to enable or disable the Notifications function. If the function is enabled the button turns blue, or if disabled the button turns gray.

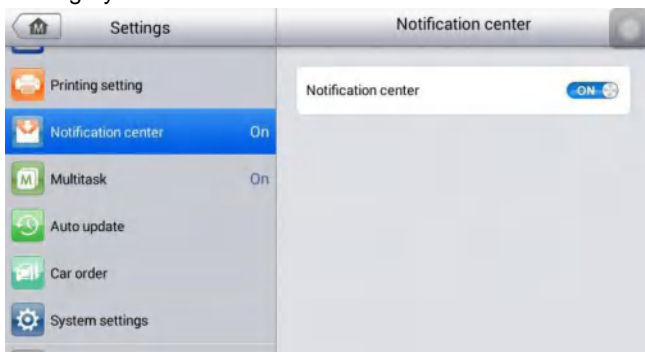

Figure 7-4 Sample Notification Screen

4. Tap the **Home** button on the top left corner to return to the MaxiPRO Job Menu or choose another setting to adjust.

When the Notification Center function is turned on, and new messages are received by the MaxiPRO device, a notification message displays on the MaxiPRO Job Menu. Press on the message bar and drag it down, and the received messages are shown in the list. Swipe up or down to view if the message list populates additional screen.

Tap a specific message to launch the corresponding application. For example, tap on an Update notification message and the Update application will launch.

Auto Update

The Auto Update allows the tool to automatically update the OS, the MaxiPRO system, and the Vehicle coverage software. Each can be configured to update automatically at specified times. Tap the **ON/OFF** button and set the desired automatic update time.

➤ **To set auto system or vehicle update**

1. Tap the **Settings** application on the MaxiPRO Job Menu.
2. Tap the **Auto Update** option on the left column. The three auto update items display on the right.

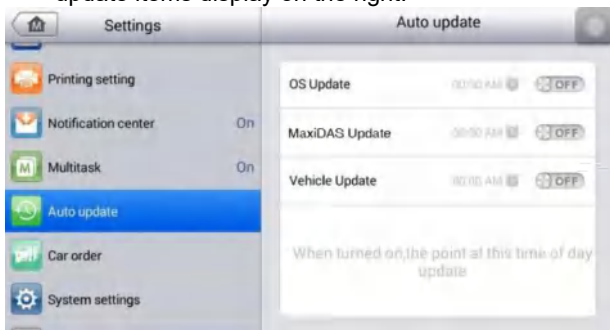

Figure 7-5 Sample Auto Update Screen

3. Select the update type to schedule. Toggle the button to ON.
4. To set download time, use the + and – button or tap on the numbers and the manual input screen will display. Tap Done to complete the time setting.

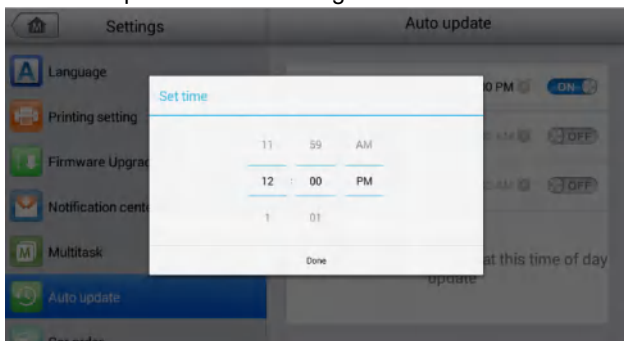

Figure 7-6 Sample Set Time Screen

NOTE

The tool must be connected to the Internet at the time download is scheduled.

To connect the MaxiVCI Mini to the test vehicle, simply insert the Vehicle Data Connector on the MaxiVCI Mini into the vehicle's DLC which is generally located under the vehicle dash and the MaxiVCI Mini will be automatically powered on.

System Settings

Access the Android system setting interface to adjust background system settings including wireless and network settings, sound and display screen settings and system security settings.

➤ **To enable the App Switcher function**

1. Tap the **Settings** application on the MaxiPRO Job Menu.
2. Tap the **System settings** option on the left column.

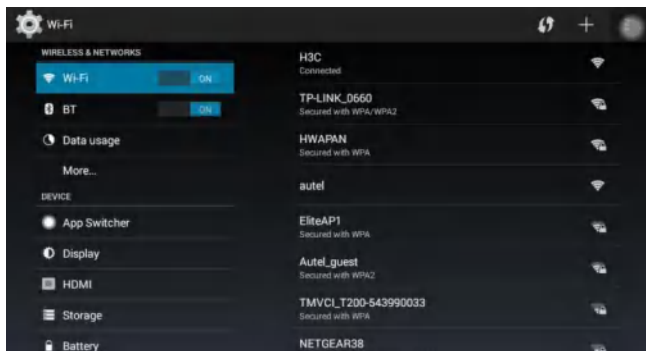

Figure 7-7 Sample System Settings Screen

3. Tap the **App Switcher** option on the left column.
4. Check the box beside “Always show the App Switcher” on the right side of the screen, then the App Switcher icon will display.

Short pressing the App Switcher icon opens a control panel:

- Tap a specific app shortcut button to access selected application screen.

- Long press a specific app shortcut button to display the app menu. The shortcut can be altered here.
- Press and drag the App Switcher icon to alter the icon position on the screen.

Refer to Android documentation for additional information about Android system settings.

About

About displays information regarding the MaxiPRO diagnostic device including the product name, version, hardware, and serial number.

- **To check the MaxiPRO product information in About**
 1. Tap the **Settings** application on the MaxiPRO Job Menu.
 2. Tap the **About** option on the left column. The product information screen displays on the right.
 3. Tap the **Home** button on the top left corner to return to the MaxiPRO Job Menu or select another setting to adjust.

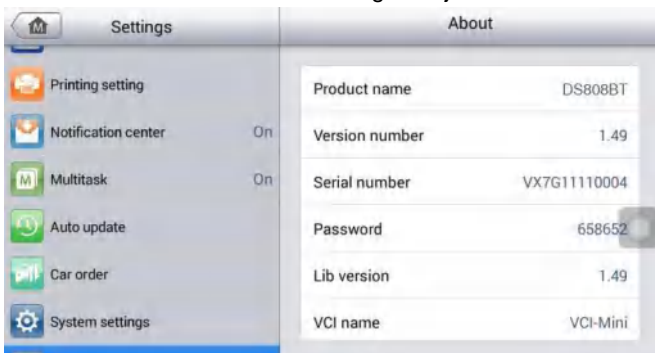

Figure 7-8 Sample About Screen

8 Update

This chapter describes the update operation for both the MP808BT tablet and the MaxiVCI Mini. The software and firmware updates of the tablet can be completed on the tablet via Internet, while the updates for MaxiVCI Mini can be completed either via the connection with the tablet or via the connection with a PC.

Tablet Update

The Update application on the tablet downloads the latest released software. The updates improve the MaxiPRO applications' capabilities, typically by adding new tests, new model coverage or by adding enhanced applications.

Software Update

The tablet automatically searches for available updates for all of the MaxiPRO software when it is connected to the Internet. Any updates that are found can be downloaded and installed on the device. This section describes update procedures in the MaxiPRO System. A notification message displays if an update is available when the Notifications Center function is enabled in the Settings application (See [Notification Center](#) page 81 for details).

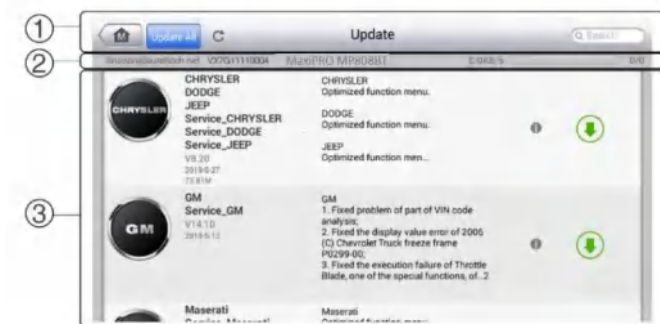

Figure 8-1 Sample Update Screen

1. Navigation and Controls
 - Home Button – returns to the MaxiPRO Job Menu.
 - Update All – updates all available updates.
 - Diagnostics Tab – displays all available vehicle diagnostic software.
 - Search Bar – search specific update item by inputting the file name, for example: enter a vehicle manufacturer.
2. Status Bar
 - Left Side – displays the MaxiPRO device model information and serial number.
 - Right Side – displays an update progress bar indicating the completion status.
3. Main Section
 - Left Column – displays vehicle buttons and update software version information; tap the **About** button to display a function list with additional software update details.
 - Middle Column – displays a brief introduction about the new changes to the software operation or capabilities. Tap **i** button to open an information screen to view more details, and tap the dim area around to close the window.
 - Right Column – according to the operation status of each software item, the button displays differently.
 - a) Tap **Update** to update the selected item.
 - b) Tap **Pause** to suspend the updating procedure.
 - c) Tap **Continue** to go on updating the suspended update.

Firmware Update

No separate update button exists to update tablet's firmware. The firmware update package will be downloaded together with the software package. An update firmware message will display.

MaxiVCI Mini Update

Update via Display Tablet

Before updating the VCI software, ensure the tablet's connection to the Internet is stable.

➤ To update the MaxiVCI Mini software

1. Power on the tablet.
2. Using a USB cable, connect the MaxiVCI Mini to the tablet.
3. Tap the **VCI Manager** application on the MaxiPRO Job Menu of the tablet.
4. Select **Update** from the connection mode list.
5. The current version and the latest version of the VCI software will be displayed after a few seconds. Click **Update Now** to update the VCI software if available.

Update via PC

1. Down the Maxi PC Suite from www.autel.com > Support > Downloads > Autel Update Tools, and install it onto your windows-PC.
2. Using a USB cable, connect the MaxiVCI Mini to a PC.
3. Launch the **PC Suite** on the PC which is installed after the installation of **Maxi PC Suite** and click MaxiVCI Mini icon in the Device Selection window.
4. The PC will automatically recognize the MaxiVCI Mini.
5. Click **Update** to complete the update if an update is available.

9 VCI Manager

This application pairs the tablet with the MaxiVCI Mini, checks the communication status and update the VCI software.

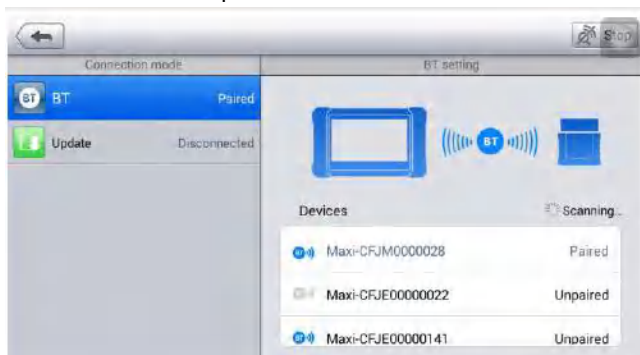

Figure 9-1 Sample VCI Manager Screen

1. Connection Mode – there are three connection modes available for selection. The connection state is displayed alongside.
 - BT Paring – when paired to a wireless device, the connection state displays as Paired; otherwise it displays as Unpaired.
 - Update (for VCI software only) – when the MaxiPRO tablet and the MaxiVCI Mini are connected by a USB cable, this function is used to update VCI software via Internet.
2. BT Setting

The BT Setting screen displays the types and product serial numbers for all the devices available for pairing. Tap a required device to start pairing. The BT status icon displayed to the left of the device name indicates the received signal strength.

BT Pairing

The MaxiVCI Mini needs to be connected to a vehicle, so that it is powered during the synchronization procedure. Ensure the tablet has sufficient battery life or is connected to an external power supply.

➤ **To pair the MaxiVCI Mini with the Tablet**

1. Power on the tablet.
2. Insert the 16-pin vehicle data connector of the MaxiVCI Mini to the vehicle data link connector (DLC).
3. Tap the **VCI Manager** application on the MaxiPRO Job Menu of the tablet.
4. Select **BT** from the connection mode list.
5. Tap the **Scan** button at the top right corner. Now the device starts searching for available pairing units.
6. The device name may display as Maxi suffixed with a serial number. Select the appropriate device for pairing.
7. When pairing is successfully done, the connection status displayed to the right of the device name is shown as **Paired**.
8. Once paired, the VCI button on the system Navigation bar at the Connection LED on the MaxiVCI Mini illuminates solid blue. This signifies that the tablet is connected to the MaxiVCI Mini, and is ready to perform vehicle diagnosis.
9. Tap the paired device again to unpair it.
10. Tap the **Home** button on the top left to return to the MaxiPRO Job Menu.

NOTE

A MaxiVCI Mini can be paired to only one tablet at a time, and once it's paired, the device will not be discoverable to other devices.

Update

Please refer to [Update via Display Tablet](#) on page [87](#) for details.

Programmer Update

Coming soon.









10 Shop Manager



The **Shop Manager** application manages the workshop information, customer information records, and test vehicle history records. There are three main functions available:

- **Vehicle History**
- **Workshop Information**
- **Customer Manager**

The operations of these functions of the Shop Manager application are mainly manipulated by the toolbar buttons, which are listed and described in the table below:

Table 10-1 Top Toolbar Buttons in Shop Manager

Button	Name	Description
	Back	Returns to the previous screen.
	Diagnostics	Tap this button to access vehicle Diagnostics menu.
	Enter Edit	Displays the editing toolbar to print or delete the selected file.
	Delete	Deletes the selected vehicle record.
	Search	Enters the vehicle name or test path to retrieve the vehicle record.
	Cancel	Cancels edit or file search.
	Edit	Edits information for the displayed file.
	Add Account	Creates a new customer account file.
	History Notes	Opens a note form. Audio, video, image and text files may be attached.

Button	Name	Description
	Vehicle History	Displays the Vehicle History which the corresponding test vehicle records.
	Done	Completes editing and saves the file.

Vehicle History

This function stores test vehicle history records, including vehicle information and the retrieved DTCs from previous diagnostic sessions. All information is displayed in summarized details. Tap on a record to resume a diagnostic session on a “stored vehicle”.

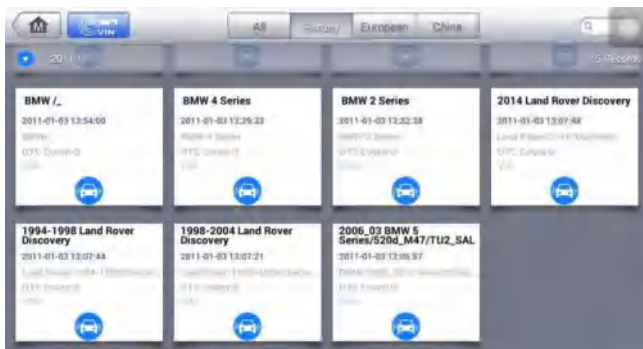

Figure 10-1 Sample Vehicle History Screen

- **To activate a test session for the recorded vehicle**
 1. Tap the **Shop Manager** application on the MaxiPRO Job Menu.
 2. Select **Vehicle History**
 3. Tap the **Diagnostics** button at the bottom of the thumbnail of a vehicle record item.
 4. Or tap the vehicle record thumbnail to view record.
 5. A Historical Test record sheet displays. Check the recorded information of the recorded test vehicle and tap the Diagnostics button on the upper right corner.

- The vehicle's Diagnostics screen displays. Now a new diagnostic session is activated, see [Diagnostics](#) on page 16 for detailed instructions on vehicle diagnostic operations.

Historical Test Record

The Historical Test record sheet is a detailed data form that includes general vehicle information such as vehicle year, make and model. The form also includes retrieved DTC from previous test and all information manually inputted by the technician.

The screenshot shows a mobile application interface titled "Historical Test". At the top, it displays "Vehicle Title: Ford Mustang". Below this, there are several sections:

- Vehicle Info:** Includes fields for Year (2008), Make (Ford), Model (Mustang), SubModel, and Engine. To the right, there are fields for VIN, License, Odometer/ Mileage, and Color.
- Service Record:** Includes a Technician field and a large text area for Technician Notes.
- Customer Info:** Includes First Name and Last Name (John) fields, and an "Add to Customer" button with a right-pointing arrow.
- DTC:** A table with columns for Status, Descriptions, and System. The current entry shows "No data".
- Activate:** A button with a circular icon.

Overlaid on the top right of the form are two buttons: "Print" and "Delete".

Figure 10-2 Sample Historical Test Record Sheet

- **To edit the Historical Test record sheet**
1. Tap the **Shop Manager** application on the MaxiPRO Job Menu.
 2. Select **Vehicle History**.
 3. Select the specific vehicle history record thumbnail from the main section. The Historical Test record sheet displays.
 4. Tap the **Edit** button to start editing.
 5. Tap on each item to input the corresponding information or add attaching files or images.



NOTE

The vehicle VIN number, or license and the customer information account are correlated by default. Adding one of the information will automatically associate the other item in the record sheet, provided that the later one exists.

6. Tap **Add to Customer** to supplement the Historical Test record sheet to an existing customer account, or add a new associated account with the test vehicle record. See [Customer Manager](#) on page 94 for more information.
7. Tap **Done** to save the updated record sheet, or tap **Cancel** to exit without saving.

Workshop Information

The Workshop Information form allows you to edit, input and save the detailed workshop information, such as shop name, address, phone number and other remarks, which when printing vehicle diagnostic reports and other associated test file, will display as the header of the printed documents.

The screenshot shows a mobile application interface for entering workshop information. The form is titled "Workshop information" and has a back arrow in the top left corner. The fields are arranged as follows: "Shop name" (single line), "Address" (multi-line), "Zip code" (single line), "City" (single line), "State" (single line), "Tel" (single line), "Fax" (single line), "Manager name" (single line), "Manager title" (single line), "Email" (single line), and "Website" (single line).

Figure 10-3 Sample Workshop Information Sheet



To edit the Workshop Information sheet

1. Tap the **Shop Manager** application on the MaxiPRO Job Menu.
2. Select **Workshop Information**.
3. Tap the **Edit** button on the top toolbar.
4. Tap on each field to input the appropriate information.

5. Tap **Done** to save the updated workshop information sheet, or tap **Cancel** to exit without saving.

Customer Manager



Use the Customer Manager function to create and edit customer accounts and correlate with the associated test vehicle history records.

➤ **To create a customer account**

1. Tap the **Shop Manager** application on the MaxiPRO Job Menu.
2. Select **Customer Manager**.
3. Tap the **Add Account** button. An empty information form displays, tap each field to input the appropriate information.

🕒 **NOTE**

Required fields are noted.

4. Tap the  photo frame beside the Name chart to add a photo. A sub menu displays, select **Take Photo** to take a new photo for the account, or select **Choose Photo** to choose from an existing image.
5. Some customers may have more than one vehicle for service; you can always add new vehicle information to the account to be correlated. Tap **Add New Vehicle Information**, and then fill in the vehicle information. Tap the  button to cancel adding.
6. Tap **Done** to save the account, or tap **Cancel** to exit without saving.

➤ **To edit a customer account**

1. Tap the **Shop Manager** application on the MaxiPRO Job Menu.
2. Select **Customer Manager**.
3. Select a customer account by tapping the corresponding name card. A Customer Information sheet displays.
4. Tap the **Edit** button on the top toolbar to start editing.
5. Tap on the input field where needs to be altered or supplemented, and enter updated information.
6. Tap **Done** to save the updated information, or tap **Cancel** to exit without saving.

➤ **To delete a customer account**

1. Tap the **Shop Manager** application on the MaxiPRO Job Menu.
2. Select **Customer Manager** and select a customer account by tapping the corresponding name card. A Customer Information sheet displays.
3. Tap the **Edit** button on the top toolbar to start editing.
4. Tap the **Delete Customer Information** button. A confirmation message displays.
5. Tap **OK** to confirm the command, and the account is deleted. Tap **Cancel** to cancel the request.

History Notes

Use the History Notes function to add audio and video records, text notes and photos for the associated customer account.

➤ **To access History Notes**







1. Tap the **Shop Manager** application on the MaxiPRO Job Menu.
2. Select **Customer Manager** or **Vehicle History**.
3. Select a customer account by tapping the corresponding name card. A Customer Information sheet displays (if **Customer Manager** is selected). Or, select a vehicle history record item to open the Historical Test record sheet (if **Vehicle History** is selected).
4. Tap the **History Notes** button on the top bar. Now the History Notes screen displays.



10-4 Sample History Notes Screen

1. **Functional Buttons** – navigates and makes various controls of the function.
2. **Main Section** – displays the note list on the left column and the detail information of the selected note on the right column.

Table 10-2 Function Buttons in History Notes

Button	Name	Description
	Back	Returns to the previous screen.
	Delete	Deletes the selected note.
	Search	Quickly locates the required note by entering the note title.
	Cancel	Cancels edit or file search.
	Edit	Tap this button to open an edit window to edit notes.
	Add Notes	Adds new note to History Notes.
	Save	Saves notes.

➤ **To add a note in History Notes**

1. Access History Notes.
2. Tap the **Add Notes** button. An edit window displays.
3. Tap on the Title bar to input a note title.
4. Tap on the blank space below to edit a text note or remark.
5. Select a function button on the top to add files in any form you choose.
6. Tap **Save** to save the note; tap **Discard** or **Cancel** to exit without saving.

11 Academy

Autel provides various tutorial articles and technical bulletins produced by top-notch technicians and product experts. Please view the materials that are saved on the tablet or view technical articles from our online forum by clicking the links displayed under this application.

12 Remote Desk

The Remote Desk application launches the TeamViewer Quick Support program, which is a simple, fast and secure remote control screen. You can use the application to receive ad-hoc remote support from Autel's support center, colleagues, or friends, by allowing them to control your MaxiPRO tablet on their PC via the TeamViewer software.

If you think of a TeamViewer connection as a phone call, the TeamViewer ID would be the phone number under which all TeamViewer Clients can be reached separately. Computers and mobile devices that run TeamViewer are identified by a globally unique ID. The first time the Remote Desk application is started, this ID is generated automatically based on the hardware characteristics and will not change later on.

Make sure the tablet is connected to the Internet before launching the Remote Desk application, so that the tablet is accessible to receive remote support from the third party.

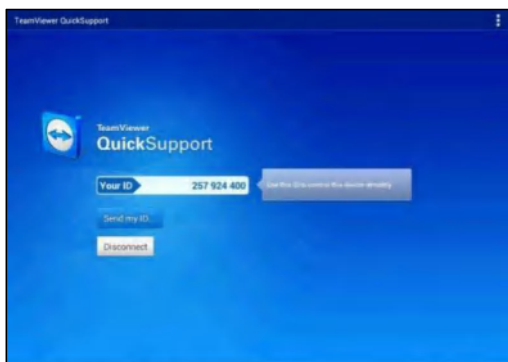

Figure 12-1 Sample Remote Desk Screen

- **To receive remote support from a partner**
 1. Power on the tablet.
 2. Tap the **Remote Desk** application on the MaxiPRO Job Menu. The TeamViewer screen displays and the device ID is generated and shown.

3. Your partner must install the Remote Control software to his/her computer by downloading the TeamViewer full version program online (<http://www.teamviewer.com>), and then start the software on his/her computer at the same time, in order to provide support and take control of the tablet remotely.
4. Provide your ID to the partner, and wait for him/her to send you a remote control request.
5. A popup displays to ask for your confirmation to allow remote control on your device.
6. Tap **Allow** to accept, or tap **Deny** to reject.

Refer to the associated TeamViewer documents for additional information.

13 MaxiFix

The MaxiFix application launches the on-line troubleshooter database, which not only provides you virtually all common diagnostic trouble code (DTC) database for most vehicles, but also serves as a forum allowing you to network with other MaxiPRO users, and gives you access to a vast database of repair and diagnostic tips along with proven filed fixes.

While the MaxiFix database keeps growing with daily troubleshooting resources and the advisory reports from the MaxiPRO users from all over the world.

Information in the MaxiFix database is organized into a series of diagnostic tips that are designed to quickly lead you to the root cause of a particular problem on the test vehicle.

Navigation

You need to register the device to your online account before launching the MaxiFix platform, see [Product Registration](#) on page 110 for details.



Figure 13-1 Sample MaxiFix Home Page

The MaxiFix screen layout consists of three main areas:

1. The Header – the tool bar across the top of the screen which allows you to select vehicles and perform searches.

2. The Main Screen – located at the center of the screen displaying content based on the vehicle attributes and keywords specified. The tabs on the main screen vary in accordance with the section selected on the Navigation Menu, allowing you to switch between functions.
3. The Navigation Menu – the main menu at the bottom of the screen, which provides you access to different sections of MaxiFix.

The Header

The Header at the top of the screen features:

- A Select Vehicle button to open the vehicle identification window, and vehicle information bar, for example “2014 > Hyundai > Accord Coupe > L4-2.4L (K24W1)”.
- A search field to find relevant information by entering keywords, codes, or problems.

Select Vehicle Button

The **Select Vehicle** button on the Header allows you to specify the vehicle which you want to research on MaxiFix, by selecting each of the vehicle attribute from a sequence of option lists. This feature helps to filter out the searches that allow only the information that applies to the identified vehicle to display.

NOTE

All attributes must be specified to make a complete vehicle selection for the most efficient search results.

➤ To select a vehicle

1. If you haven't already done so, click the **Select Vehicle** button on the Header.
2. Select the **year** of the vehicle from the list.
3. Select the **make** of the vehicle from the list.
4. Select the **model** of the vehicle from the list.
5. Select the **submodel** of the vehicle from the list.
6. Select the **engine** of the vehicle from the list.

After completing the vehicle selection procedure, the identified vehicle is shown on the Header.

Terminology

MaxiFix Tip

A MaxiFix Tip provides practical information of real fix of a specific vehicle repair issue with detailed descriptions. It is combined with proven fix and vehicle specific data, and filed into an all-in-one information source to provide you with quick and easy repair solutions.

On MaxiFix community you can find Tips or share your own Tip with the community.

➤ **To search for a MaxiFix Tip**

1. Select a Vehicle:
 - a) Click **Select Vehicle** on the Header at the top of the page.
 - b) Select the **year** of the vehicle from the list.
 - c) Select the **make** of the vehicle from the list.
 - d) Select the **model** of the vehicle from the list.
 - e) Select the **submodel** of the vehicle from the list.
 - f) Select the **engine** of the vehicle from the list.

After completing the vehicle selection procedure, the identified vehicle is shown on the Header.

2. Enter a Search Term.

MaxiFix has an exclusive one-stop lookup that helps you find all of MaxiFix resources by one click. Simply enter a search term into the search bar on the Header to begin the search.

3. Proven Results!

The powerful MaxiFix database gives you proven results! The typical MaxiFix Tips combine actual workshop fixes and data which may include:

- a) OBD II Fault Codes description and reference — helps in diagnostic assessment by making clear the nature of an automotive problem so that beginner and advanced technicians can make effective repairs.

- b) Real Fix Tips – provides repair tips from actual shop practices and are presented in an easy to understand Complaint, Cause, Correction format.

If you still can't find the information you want, you can ask the MaxiFix community for help by clicking **Ask** on the Navigation Menu at the bottom of the screen.

Adopted!

The **Adopted!** icon that displays at the top right side of a Tip page indicates that the related Tip has been adopted by at least 1 technician in the community. If a tip has helped you to solve a repair problem, you are encouraged to give an Adopted! count to the tip. Each member is allowed to click the “Adopted!” once for a tip, and each click will add 1 count to the total number of “Adopted!” The “Adopted!” count helps you easily identify which tips are really helpful for repairing vehicle issues. You can also post a comment about how the tip has helped you as reference to other members.

Operations

The Navigation Menu is at the bottom of the screen. Selecting the items on the Navigation Menu allows you to switch between the main sections on MaxiFix. These main sections include:

- Home – shows all questions and allows you to specify questions about one or multiple makes.
- Search Fix – allows you to search for information from all available resources on MaxiFix, including: Open Questions, Tips, and Real Fixes, and displays search results.
- Ask – allows you to ask a question in the community.
- My MaxiFix – shows all your posts including Questions and Fixes in the community, and allows you to view your personal profile, select your vehicle preference, and share your tips.
- My Messages – shows a list of message notifications which is relevant to your activities in the Question section.
- **Support** – opens the FAQ page, or a message box for contacting Customer Service by email.

Home

Home is the first option on the Navigation Menu at the bottom of the screen. Tapping it opens your MaxiFix home page. There is a list of questions posted on the community, and you can scroll down the page to the bottom and view more questions by tapping **View More**. Click on any question and you will be linked to the detailed page in the Ask section.

You can configure your main screen to display questions only related to the vehicle makes you are interested in, by clicking the “Filter” button on the main page of Home, and select the desired vehicle makes. This filter can be canceled anytime by clicking the “Remove All Filters” button, and the default setting will be restored to display questions about all vehicle makes.

Search Fix Features

Search Fix, the second option on the Navigation Menu at the bottom of the screen, presents search results for the specified vehicle. Search results are listed in various categories:

- **All** – includes all search results, including related Questions, Tips, and Real Fixes to your search.
- **Questions** – presents a list of open Question discussed in the community that may be pertinent to your search.
- **Tips** – presents a list of Tips that directly correlate to your search criteria. Select a Tip from the list to open and review the complete Tip.
- **Real Fixes** – presents a list of Tips that have been collected from actual shop repair orders and are presented in an easy-to-understand Complaint, Cause, and Correction format.

Ask

Ask, the third option on the Navigation Menu at the bottom of the screen, allows you to ask a question about a particular vehicle repair issue in the community.

➤ **To ask a MaxiFix Question**

1. Click **Select Vehicle** on the Header to specify the vehicle you are asking about.

2. Click **Ask** on the Navigation Menu at the bottom of the screen to open the Ask page.
3. On the **Ask** page find **Ask for Help**, fill in the following sections to ask a question.

The Ask page has four sections:

- Subject – this is where you enter a brief subject for the question.
- My Question – asks a clear and concise question that you want to ask the community. Be sure to be descriptive and concise when asking your question.
- Problem Description – describes how the vehicle is behaving.
- Repair History – includes any previous diagnostic tests that you performed, including the results of the tests. Also list any parts that were replaced during previous diagnostic work.

Tap **Cancel** to cancel your question and return to the Ask page.

Tap **Submit** to post your question to the community.

Tap **Attach File** to include images or reference files with your question.

You are requested to select one Adopted Answer from all of the responses and then close the question. For details, please refer to [My Messages](#) on page 107.

My MaxiFix

My MaxiFix, the fourth option on the Navigation Menu at the bottom of the screen, opens your personal MaxiFix page. To access the features on My MaxiFix page you can select from the tabs:

- My Questions – opens a list with links to the opened questions that you have posted to the community.
- My Cases – opens a list with links to the closed questions and tips that you have contributed to the community.
- Marked Posts – opens a list with links to Tips and discussions that you are actively participating in.

- **My Profile** – allows you to view your Autel account information including: your Autel ID, personal information, MaxiFix score, phone number and register time, and edit your portrait.
- **Vehicle Preference** –used to set up a list of preferred vehicles. The preferred list allows you to limit the choices that displayed on the **Select Vehicle** list to specific years, and makes. Click **Set Year** or **Set Make** to set your preferred models. The preferred makes will also be displayed in the **Filter** options on the Home page.
- **Share a Tip** – allows you to share your personal repair experience with the community.

Click **My MaxiFix** on the Navigation Menu at the bottom of the screen, to display all questions and tips that you have contributed to the community.

Create a Tip

A “Tip” is a concise and complete description of the fix for a particular vehicle repair issue.

➤ **To create a new MaxiFix Tip**

1. Select **My MaxiFix** from the Navigation Menu.
2. Select **Select Vehicle** from the Header and enter the identifying attributes of the vehicle you are writing the Tip about.
3. On the My MaxiFix page find **Share a Tip**; click this link to open the **My Tips** page.
4. Enter the Tip subject in the **Subject** field.
5. Compose your Tip in the **Description** field. Include as much information as possible, while keeping the information concise and to the point. A Tip should provide accurate information that is reader-friendly.

Use the **Cancel** button at the right-side bottom of the page to cancel your tip and return to the My MaxiFix page.

Or use the **Submit** button at the right-side bottom of the page to contribute your tip to the community.

Use the **Attach File** button at the left-side bottom of the page to include images or other supporting data with your question.

View Profile Information

You can view your personal profile by clicking on your account ID or “My Profile” in My MaxiFix section or edit portrait where applicable, and visit other community members’ profile by clicking their portrait. Information included in your profile determines how you are presented to the community, and what type of information will be sent to you from the community.

My Messages

My Messages, the fifth option on the Navigation Menu at the bottom of the screen, shows a list of message notification which is relevant to your activities in the Question section. A notification icon will appear on the top-right corner of “My Messages” if there is any new or unread message in the Question section. The number on the notification icon indicates the total number of the new and unread messages. The displayed number will be reduced correspondingly after viewing. The message notification will appear under the following two conditions:

1. Your question or answer is replied by other MaxiFix community members.
2. Your answer is marked as the “Adopted!” by the MaxiFix community member who asked the question.

Tap **My Messages**, select and open the message you want to read from the list. If your problem is solved according to the reply, you should select one Adopted Answer and close the question. If your answer is marked as “Adopted!”, the prompt “Adopted! + 4” will be displayed permanently.

Tap **Clear** to delete all message notifications.

Select “Adopted Answers”

Members are requested to select one Adopted Answer from all of the responses on “My Messages” page before closing a question. The community members who provided the Adopted Answer are rewarded with scores for their contribution.

About Adopted Answer:

- Only one answer can be selected as “Adopted Answer”.

- Answers can only be rated by the MaxiFix member who asked the question.

Close a Question

When a repair question that you've posted to the community is resolved, you are encouraged to write down the case as a way to share a good solution. This will help the other MaxiFix members to find useful information for practical fix.

To close a question, you need to select the question's response message from the message list on **My Messages** page first, then tap **Adopted Answer** and select **Close Question**. Tap the **Cancel** button to cancel your submission and return to My Messages page. It is strongly recommended to share your repair solutions before closing a question. Your question will be converted to a MaxiFix Community Tip after closing.

Score Rewarding System

1. A score of 4 is awarded if your answer is selected as the "Adopted Answer".
2. A score of 3 is awarded when you close a question.
3. A score of 2 is awarded if your closed question is marked as "Adopted!" by no less than 20 community members.
4. A score of 1 is awarded if your answer is selected as the "Adopted Answer" for a closed question which is marked as "Adopted!" by no less than 20 community members.
5. A score of 1 is awarded to each of the first three respondents.

Support

Support, the last option on the Navigation Menu at the bottom of the screen, opens a page that provides two ways to gain support from MaxiFix:

1. A message form to contact the administrator of MaxiFix.
2. A Frequently Asked Questions (FAQ) link that answers the most frequent questions from MaxiFix community members.

If you wish to contact the administrator of MaxiFix site, please use the contact form. Select **Support** from the Navigation Menu to open the comment

window. To allow the administrator to respond to your question or issue, the following information should be provided:

- Your name
- A contact email address
- A contact phone number

14 Support

This application launches the Support platform which synchronizes Autel's on-line service base station with the tablet. In order to synchronize the device to your on-line account, you need to register the product through the Internet when you use it for the first time. The Support application is connected to Autel's service channel and on-line communities which provides the quickest way for problem solutions, allowing you to submit complaints or sent help requests to obtain direct services and supports.

Product Registration

Register your MaxiPRO Diagnostic Device to access the Support platform and download update.

➤ **To register the diagnostic device**

1. Visit the website: <http://pro.autel.com>.
2. If you already have an Autel account, sign in with your account ID and password.
3. If you are a new member to Autel, click on the **Create Autel ID** button on the left side of the screen to create an ID.
4. Enter the required information in the input fields, and click **Get Verification Code** button to get a verification code for email validation.
5. The online system will automatically send a verification code to the registered email address. Input the code in the Verification code field and complete other required fields. Read through Autel's Terms and Conditions and click on **Agree**, and then click **Create Autel ID** at the bottom. A product registration screen will display.
6. The device's serial number and password is located in the *About* section of the Settings application screen will display.
7. Select your product model, enter the product serial number and password on the Product Registration screen, and click **Submit** to complete the registration procedure.

Support Screen Layout

The Support application interface is navigated via four simple buttons on the top navigation bar, operation of each is described below in turn from left to right:

- Home Button – returns to the MaxiPRO Job Menu.
- Back – returns to the previous screen, each press takes you back one step.
- Forward – each press moves forward one screen until you've reached the last screen visited.
- Refresh – reloads and updates the screen.



Figure 14-1 Sample Support Application Screen

The main section of the Support screen is divided into two sections. The narrow column on the left is the main menu; select one subject from the main menu to display the corresponding functional interface on the right.

My Account

The My Account screen displays the comprehensive information of the user and the product, which is synchronized with the on-line registered account, including User Info, Device Info, Update Info and Service Info.

Personal Info

The User Info and Device Info are both included under the Personal Info section.

- User Info - displays detailed information of your registered on-line Autel account, such as your Autel ID, Name, Address and other contact information, etc.
- Device Info – displays the registered product information, including the Serial Number, Registration Date, Expire Date, and Warranty Period.

Update Info

The Update Info section displays a detailed record list of the product's software update history, including the product serial number, software version or name, and the update time.

Service Info

The Service Info section displays a detailed record list of the device's service history information. The device's serial number and a detailed repair report, such as the fault type, changed components, or system reinstallation, will be listed.

User Complaint

The User Complaint screen allows you to establish a new complaint case, as well as to view historical complaint records.

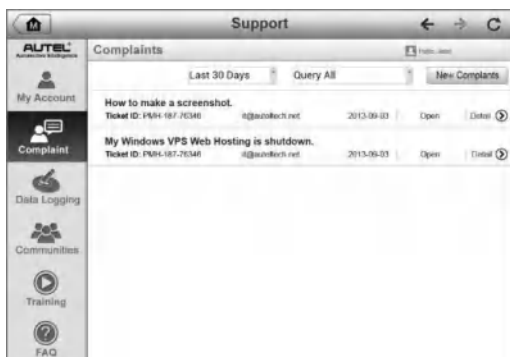

Figure 14-2 Sample Complaint Screen

The User Complaint screen consists of two parts.

1. Option Bar

- Period Filter – displays only the complaint records within the defined period on the list.
- Status Filter – displays the corresponding complaint records according to the selected case status.
- New Complaint Button – starts a new complaint case.

2. Complaint List

The complaint list normally displays all the complaint records of all time and all status by default. The summary information for each complaint item includes the Subject Name, Ticket ID, User's Account ID, Date, and the Case Status.

There are four case status types:

- Open – indicates the complaint case has been started but not processed.
- Suspended – indicates the complaint case is being processed.
- Waiting Customer Reply – indicates the complaint has been replied by the service personnel, and requires feedback from the customer.
- Closed – indicates the complaint case has been processed, resolved, and closed.

To view the detailed complaint session, tap the  button on the right side of the case item.

➤ **To establish a new complaint session**

1. Register the product online.
2. Tap the **Support** application on the MaxiPRO Job Menu. The device information is automatically synchronized with the online account.
3. Tap **Complaint** on the Main Menu.
4. Tap the **New Complaint** button at the upper right corner. A selection menu with a category of service channels displays.
5. Select a target service channel and click **Next** to continue. A standard complaint form displays, on which you are allowed to enter detailed information, such as personal information, vehicle information, and device information, you can also attach image or PDF files with the form.

6. Enter in each input field the appropriate information. In order to settle the complaint more efficiently, it is recommended to fill out the complaint form as completely as possible.
 7. Select the required processing time on the last section according to the urgency of the case.
 8. Tap **Submit** to send the completed form to Autel's online service center, or tap **Reset** to refill it. The submitted complaints will be carefully read and handled by the service personnel, and the respond speed may depend on the processing time you've required.
- **To make a reply in a complaint session**
1. Register the product online.
 2. Tap the **Support** application on the MaxiPRO Job Menu. The device information is automatically synchronized with the online account.
 3. Tap **Complaint** on the Main Menu.
 4. Select an existing complaint case item on the record list by tapping the ⊖ button on its right side. The screen displays the complaint session details.
 5. Tap the **Post Reply** button on the upper right side after viewing, to make a reply. An edit screen displays.
 6. Input the content in the input field, and if necessary, upload an attaching file.
 7. Tap **Submit** to post the reply.
 8. Tap the **States** selection drop-down menu to reset a case state.
 9. Tap the **Update** button to commit the newest update.

Data Logging

The Data Logging section keeps records of all **Feedback** (submitted), **Not Feedback** (but saved) or **History** (up to the latest 20 test records) data loggings on the diagnostic system. The support personnel receive and process the submitted reports through the Support platform, and send back problem solutions within 48 hours. Support personnel will answer your questions directly.

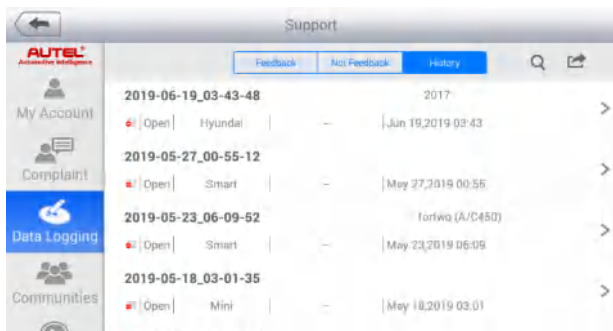

Figure 14-3 Sample Data Logging Screen

- **To make a reply in a Data Logging session**
 1. Tap on the **Feedback** tag to view a list of submitted data loggings.
 2. Select a specific item to view the latest update.
 3. Tap on the input field at the bottom of the screen, and enter texts. Or tap the Audio button to record a voice message or camera button to include an image.
 4. Tap **Send** to send message to the technical center.

Communities

The Communities section launches and synchronizes with the Technical Forums on Autel's official website www.autel.com, where you are allowed to discuss technical topics or share information with, as well as ask for technical advices or offer technical supports to all other members in Autel's online support communities.

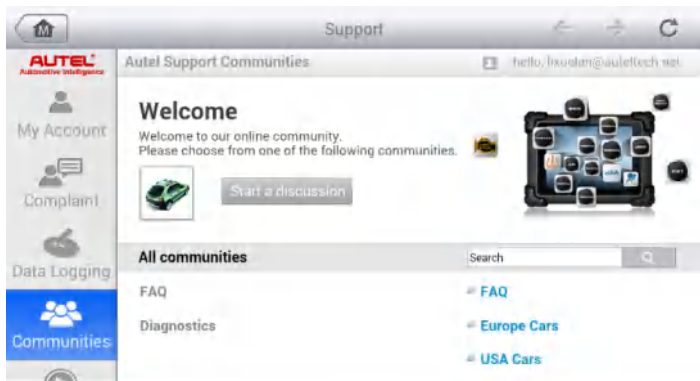

Figure 14-4 Sample Communities Home Screen

➤ **To start a discussion**

1. Tap **Start a discussion** on the Communities Home screen. A list of the major forums is displayed.
2. Select the appropriate device heading. For example, if you are going to ask a question about the MaxiPRO tablet, tap **MaxiPRO** to start a discussion.
3. Enter your topic and the discussion content in the appropriate input field.
4. Select a category or edit tags for the discussed post. This will help other members with similar interest to find your post.
5. Tap **OK** to submit the post.

➤ **To join and reply to a discussion post**

1. Select a forum group, whether by the product or the features, on the Communities Home screen. A list of the latest posts is displayed.
2. Select a specific category on the Categories menu to better pinpoint the topics you are most interested with.
3. Tap the ⊖ button on the right side of the topic item to view the discussion. The posts contents are displayed.
4. Browse through all the posts by sliding the screen up and down. Tap **Go to original post** when reaching the end of the discussion to return to the first post.

5. Tap **Reply** to reply a specific post, or tap **Reply to original post** to join and continue the whole discussion.
6. Enter your comment in the input field, and tap **OK** to submit your post.

User Profile

The User Profile section allows you to set personal Avatar, check your member status and other information, as well as to review your personal posts in the communities.

Tap the Avatar image on the Communities screen to open the User Profile.

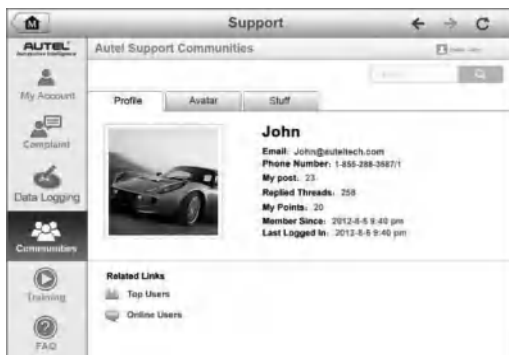

Figure 14-5 Sample User Profile Screen

- Profile – displays the user’s personal information and member status. The **Related links** allow you to check the Top Users (ranked according to their points and levels) in the communities, as well as to find out other online users.
- Avatar – allows you to select an image to set as your personal Avatar to be displayed in the communities.
- Stuff – displays all the discussions you’ve posted at various forums in a list.

Training Channels

The Training section provides quick links to Autel’s online video accounts. Select a video channel by the language to see all the available online tutorial videos from Autel for various technical supports, such as product usage techniques and vehicle diagnostics practice.

FAQ Database

The FAQ section provides you comprehensive references for questions frequently asked and answered about the use of Autel's online member account, and shopping and payment procedures.

- Account – displays questions and answers about the use of Autel's online user account.
- Shopping & Payment – displays questions and answers about online product purchase and payment methods or procedures.

15 Quick Link

The Quick Link application provides convenient access to Autel's official website and to additional in automotive service sites.

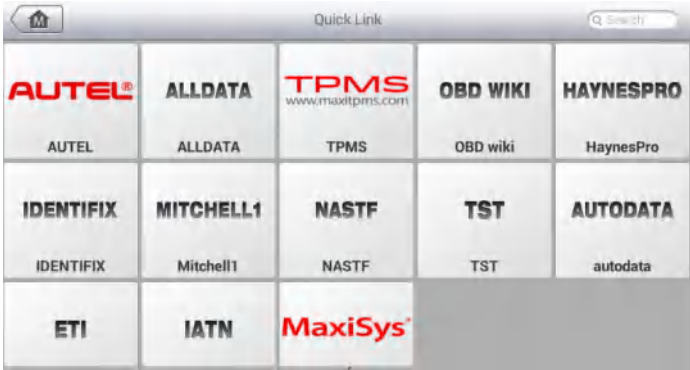

Figure 15-1 Sample Quick Link Screen

➤ To open a quick link

1. Tap the **Quick Link** application on the MaxiPRO Job Menu. The Quick Link application screen displays.
2. Select a website thumbnail from the main section. The Chrome browser is launched and the selected website is opened.

16 Function Viewer

The Function Viewer allows you to search the functions supported by our tools and the software version information. There are two ways of searching, either by searching the tool and the vehicle or searching the functions.

➤ To Search by the vehicle

1. Tap the **Function Viewer** application on the MaxiPRO Job Menu. The Function Viewer application screen displays.
2. Tap the tool name on the top left to drop down the tool list, tap the one you want to search.

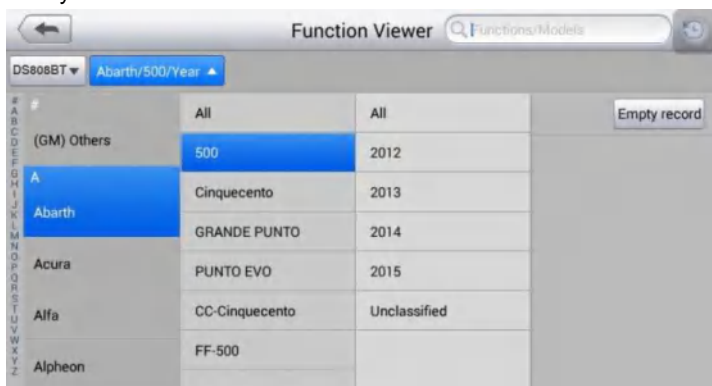

Figure 16-1 Sample Function Viewer Screen 1

3. Tap the vehicle brand, model, and year you want to search.
4. All the functions support by the selected tool for the selected vehicle displays with three column, function, sub function, and version.

Year	System	Sub system	Capacity	Function	Sub function	Version
/	/	CONTINENTAL Airbag (EP)	1.4 TURBO 16V	ECU Info.	/	Above Abarth_V1.01
/	/	CONTINENTAL Airbag (EP)	1.4 TURBO 16V	Erase Codes	/	Above Abarth_V1.01
/	/	CONTINENTAL Airbag (EP)	1.4 TURBO 16V	Live Data	/	Above Abarth_V1.01
/	/	CONTINENTAL Airbag (EP)	1.4 TURBO 16V	Read Codes	/	Above Abarth_V1.01
/	/	DELPHI (EP) 2 Power Steering	1.4 TURBO 16V	ECU Info.	/	Above Abarth_V1.01

Figure 16-2 Sample Function Viewer Screen 2

➤ **Search by the functions**

1. Tap the **Function Viewer** application on the MaxiPRO Job Menu. The Function Viewer application screen displays.
2. Tap the tool name on the top left to drop down the tool list, tap the one you want to search.
3. Type in the function you want to search to the top right search column. All the vehicles with this function will be listed with 8 columns, the Brand, Model, Year, System, Sub system, Function, Sub function, and Version.

🔪 **NOTE**

Fuzzy search is supported, type in part of the function you want to search can also find you all the related.

Brand	Model	Year	System	Sub system	Function	Sub function	Version
Chery	Arrizo 5	/	Immobilizer System	Chery Self-developed...	Special functions	Reset ECM	Above Chery_V...
Chery	Arrizo 7	/	Immobilizer System	Chery Self-developed...	Special functions	Reset ECM	Above Chery_V...
Chery	E3	/	Immobilizer System	Chery Self-developed...	Special functions	Reset ECM	Above Chery_V...
Chery	Tiggo 3X	/	Immobilizer System	Chery Self-developed...	Special functions	Reset ECM	Above Chery_V...
Chery	Tiggo 7	/	Immobilizer System	Chery Self-developed...	Special functions	Reset ECM	Above Chery_V...

Figure 16-3 Sample Function Viewer Screen 3

17 Maintenance and Service

Maintenance Instructions

Follow these guidelines to maintain your tool and ensure its optimum performance.

- Use a soft cloth and alcohol or a mild window cleaner to clean the touch screen of the tablet.
- Do not use any abrasive cleansers, detergent, or automotive chemicals to the tablet.
- Maintain the devices in dry conditions and keep them within normal operating temperatures.
- Dry your hands before using the tablet. The touch screen of the tablet may not work if the touch screen is moist, or if you tap the touch screen with wet hands.
- Do not store the devices in humid, dusty or dirty areas.
- Check the housing, wiring, and connectors for dirt and damage before and after each use.
- At the end of each work day, wipe the device housing, wiring, and connectors clean with a damp cloth.
- Do not attempt to disassemble your tablet or the MaxiVCI Mini.
- Do not drop or cause severe impact to the devices.
- Use only authorized battery chargers and accessories. Any malfunction or damage caused by the use of unauthorized battery charger and accessories will void the limited product warranty.
- Ensure that the battery charger does not come in contact with conductive objects.
- Do not use the tablet beside microwave ovens, cordless phones and some medical or scientific instruments to prevent signal interference.

Troubleshooting Checklist

- A. When the tablet does not work properly:
- Ensure the tablet has been registered online.
 - Ensure the system software and diagnostic application software are properly updated.
 - Ensure the tablet is connected to the Internet.
 - Check all cables, connections, and indicators to see if the signal is being received.
- B. When battery life is shorter than usual:
- This may happen when you are in an area with low Wi-Fi signal strength. Turn off your device when not in use.
- C. When the tablet cannot be turned on:
- Ensure the tablet is connected to a power source or the battery is charged.
- D. When you are unable to charge the tablet:
- Your charger maybe out of order. Contact your nearest dealer.
 - You may be attempting to use the device in an overly hot/cold temperature. Try changing the charging environment.
 - Your device may have not been connected to the charger properly. Check the connector.

NOTE

If your problems persist, please contact Autel's technical support personnel or your local selling agent.

About Battery Usage

Your tablet is powered by a built-in Lithium-ion Polymer battery. This means that, unlike other forms of battery technology, you can recharge your battery while some charge remains without reducing your tablet's autonomy due to the "battery memory effect" inherent in those technologies.

 **DANGER**

1. The built-in Lithium-ion Polymer battery is factory replaceable only; incorrect replacement or tampering with the battery pack may cause an explosion.
 2. Do not use a damaged battery charger.
-

- Do not disassemble or open crush, bend or deform, puncture or shred.
- Do not modify or remanufacture, attempt to insert foreign objects into the battery, expose to fire, explosion or other hazard.
- Make sure to use the charger and USB cables only that come together in the package. If you use the other charger and USB cables, you might incur malfunction or failure of the device.
- Only use the charging device that has been qualified with device per the standard. Use of an unqualified battery or charger may present a risk of fire, explosion, leakage, or other hazard.
- Avoid dropping the tablet. If the tablet is dropped, especially on a hard surface, and the user suspects damage, contact support.
- Move the tablet closer to your network's base station to improve battery life.
- The battery recharging time varies depending on the remaining battery capacity.
- Battery life inevitably shortens over time.
- Since over charging may shorten battery life, remove the tablet from its charger once it is fully charged. Unplug the charger, once charging is complete.
- Leaving the tablet in hot or cold places, especially inside a car in summer or winter, may reduce the capacity and life of the battery. Always keep the battery within normal temperatures.

Service Procedures

This section introduces information for technical support, repair service, and application for replacement or optional parts.

Technical Support

If you have any question or problem on the operation of the product, please contact us (see the following contact info) or your local distributor.

AUTEL CHINA HQ

- Phone: 0086-755-8614 7779
- Website: www.autel.com
- Email: support@autel.com
- Address: 7th, 8th, 10th floor, Building B1, Zhiyuan, Xueyuan Road, Xili, Nanshan, Shenzhen, 518055, China

AUTEL NORTH AMERICA

- Phone: 855-AUTEL-US (855-288-3587) Monday-Friday 9am-6pm EST
- Website: www.autel.com
- Email: ussupport@autel.com
- Address: Suite 200, 175 Central Avenue, Farmingdale, New York, USA. 11735

AUTEL EUROPE

- Phone: 0049 (0) 61032000520
- Website: www.autel.eu
- Email: sales.eu@autel.com/support.eu@autel.com
- Address: AdalperostraÙe 82, 85737 Ismaning, Germany

AUTEL SOUTH AMERICA

- Phone: (+507) 308-7566
- Website: www.autel.com/es
- Email: sales.latin@autel.com/latsupport@autel.com

- Address: Office 103, Building 3845, International Business Park, Veracruz, Panamá Pacífico, Panamá

AUTEL AUSTRALIA

- Phone: 03 9480 2978 / +61 476293327
- Website: www.autel.com.au
- Email: sales@autel.com.au
- Address: 155 Islington Street, Melbourne, Collingwood, VIC

Repair Service

If it becomes necessary to return your device for repair, please contact us first and then download the repair service form from www.autel.com, and fill it in. The following information must be included:

- Contact name
- Return address
- Telephone number
- Product name
- Complete description of the problem
- Proof-of-purchase for warranty repairs
- Preferred method of payment for non-warranty repairs

NOTE

For non-warranty repairs, payment can be made with Visa, Master Card, or with approved credit terms.

Send the device to your local agent, or to the below address:

8th Floor, Building B1, Zhiyuan, Xueyuan Road, Xili, Nanshan, Shenzhen, 518055, China

Other Services

You can purchase the optional accessories directly from Autel's authorized tool suppliers, and/or your local distributor or agent.

Your purchase order should include the following information:

- Contact information
- Product or part name
- Item description
- Purchase quantity

18 Compliance Information

FCC Compliance

FCC ID: WQ8-1610MX808

This device complies with Part 15 of the FCC rules and Industry Canada's license-exempt RSSs. Operation is subject to the following two conditions:

1. This device may not cause harmful interference.
2. This device must accept any interference received, including interference that may cause undesired operation.

Cet appareil est conforme aux CNR exempts de licence d'Industrie Canada. Son fonctionnement est soumis aux deux conditions suivantes:

1. Ce dispositif ne peut causer des interférences; et
2. Ce dispositif doit accepter toute interférence, y compris les interférences qui peuvent causer un mauvais fonctionnement de l'appareil.

 **WARNING**

Changes or modifications not expressly approved by the party responsible for compliance could void the user's authority to operate the equipment.

 **NOTE**

This equipment has been tested and found to comply with the limits for a Class B digital device, pursuant to Part 15 of the FCC Rules. These limits are designed to provide reasonable protection against harmful interference in a residential installation.

This equipment generates uses and can radiate radio frequency energy and, if not installed and used in accordance with the instructions, may cause harmful interference to radio communications. However, there is no guarantee that interference will not occur in a particular installation. If this equipment does cause harmful interference to radio or television reception, which can be determined by turning the equipment off and on, the user is encouraged to try to correct the interference by one or more of the following measures:

- Reorient or relocate the receiving antenna.
- Increase the separation between the equipment and receiver.
- Connect the equipment into an outlet on a circuit different from that to which the receiver is connected.
- Consult the dealer or an experienced radio/TV technician for help.

Changes or modifications not expressly approved by the party responsible for compliance could void the user's authority to operate the equipment.

SAR

The radiated output power of this device is below the FCC radio frequency exposure limits. Nevertheless, the device should be used in such a manner that the potential for human contact is minimized during normal operation.

The exposure standard for wireless devices employs a unit of measurement known as the Specific Absorption Rate, or SAR. The SAR limit set by the FCC is 1.6 W/Kg. Tests for SAR are conducted using standard operating positions accepted by the FCC with the device transmitting at its highest certified power level in all tested frequency bands.

Although the SAR is determined at the highest certified power level, the actual SAR level of the device while operating can be well below the maximum value. This is because the device is designed to operate at multiple power levels so as to use only the power required to reach the network. To avoid the possibility of exceeding the FCC radio frequency exposure limits, human proximity to antenna should be minimized.

RF WARNING STATEMENT

The device has been evaluated to meet general RF exposure requirement. The device can be used in portable exposure condition without restriction.

RoHS COMPLIANCE

This device is declared to be in compliance with the European RoHS Directive 2011/65/EU.

CE COMPLIANCE

This product is declared to conform to the essential requirements of the following Directives and carries the CE mark accordingly:

EMC Directive 2014/30/EU

R&TTE Directive 2014/53/EU

Low Voltage Directive 2014/35/EU

19 Warranty

Limited One Year Warranty

Autel Intelligent Technology Corp., Ltd. (the Company) warrants to the original retail purchaser of this MaxiPRO Diagnostic Device that should this product or any part thereof during normal usage and under normal conditions be proven defective in material or workmanship and results in product failure within 1 year period from the date of purchase, such defect(s) will be repaired, or replaced (with new or rebuilt parts) with Proof of Purchase, at the Company's option, without charge for parts or labor directly related to the defect(s).

The Company shall not be liable for any incidental or consequential damages arising from the use, misuse, or mounting of the device. Some states do not allow limitation on how long an implied warranty lasts, so the above limitations may not apply to you.

This warranty does not apply to:

- 1) Products subjected to abnormal use or conditions, accident, mishandling, neglect, unauthorized alteration, misuse, improper installation or repair or improper storage;
- 2) Products whose mechanical serial number or electronic serial number has been removed, altered or defaced;
- 3) Damage from exposure to excessive temperatures or extreme environmental conditions;
- 4) Damage resulting from connection to, or use of any accessory or other product not approved or authorized by the Company;
- 5) Defects in appearance, cosmetic, decorative or structural items such as framing and non-operative parts.
- 6) Products damaged from external causes such as fire, dirt, sand, battery leakage, blown fuse, theft or improper usage of any electrical source.



IMPORTANT

All contents of the product may be deleted during the process of repair. You should create a back-up copy of any contents of your product before delivering the product for warranty service.
