

# **GODIAC ECU IMMO Prog AD GT105**

OB2 II Breakout Box ECU Connector

Used to short-circuit car OB2 for IMMO activation matching,

ECU programming connection

## **Instructions**

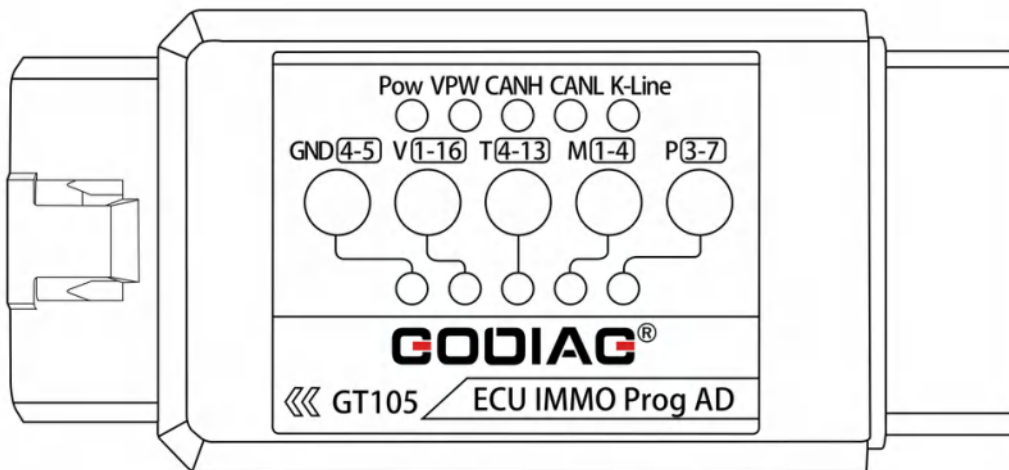

**2.2022**

## 1. Product Introduction

**GODIAG ECU IMMO Prog AD GT105** is a dedicated connection adapter developed for automotive service technicians, IMMO matching technicians and ECU programming engineers. The product is suitable for outdoor work, taking power from the car battery and converting it into a DC12V power supply for 12V charging, programming power, or independent power supply for diagnostic equipment.

The device provides OBD2 independent PIN4 body GND, PIN5 signal GND, which is convenient for some modules to be used for special programming. In addition, with the OBD2 full protocol ECU programming cable, users can also connect the ECU in the studio to adjust the ECU programming power.

The device has PWM+(PIN2), CANH(PIN6), CANL(PIN14), K-line(PIN7) signal communication indicators. When there is data communication, the corresponding protocol indicator will flash. Users can judge the communication status, and also can judge whether the diagnostic programming device can communicate.

### Product Structure

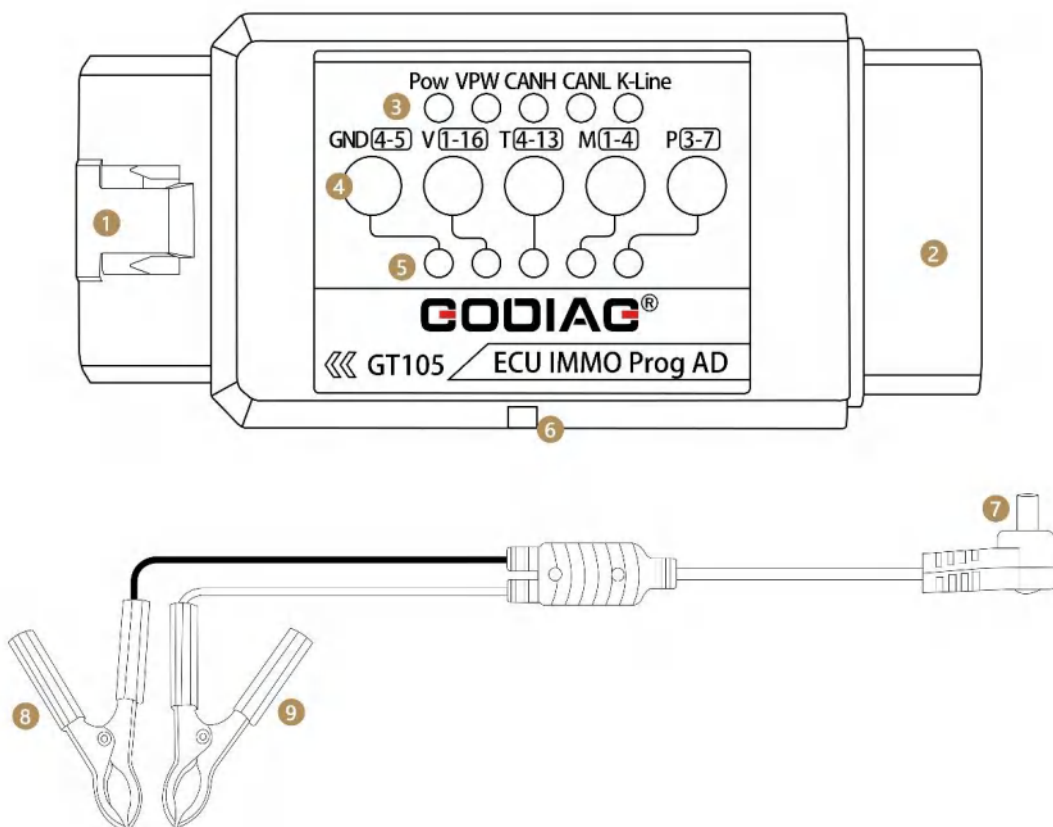

- (1) OBD2 male connector- used to connect the car OBD2 diagnostic interface.
- (2) OBD2 female connector - used to connect diagnostic programming equipment.
- (3) Pow power indicator VPW CANH CANL K-Line protocol indicator. Used to determine whether the device or vehicle is communicating.

- (4) GND4-5, V1-16, T4-13, M1-4, P3-7 function keys.
- (5) GND4-5, V1-16, T4-13, M1-4, P3-7 function keys, corresponding indicator lights.
- (6) DC power input interface.
- (7) Battery to DC output jack
- (8) Battery negative clip
- (9) Battery positive clip

### **Function Introduction**

1. IMMO AD Ford all smart keys lost, VVDI equipment (OBDSTAR, AUTEL) and other IMMO matching equipment. For all-loss matching, you need to disconnect the car battery, connect it to the negative pole of the battery through OBD5, and connect the 16 pin to the positive pole of the 12v battery.

For example: use the Xhorse key tool plus pad to match the new Ford models after 2017. When all the keys are lost, the vehicle is in the alarm state, and the tablet cannot be used to match. If you want to match the keys, you must release the IMMO state. The steps to release the IMMO status are as follows:

#### **Steps:**

1. Xhorse key tool plus pad enters the IMMO matching option, and prepares 2 VVDI smart card keys. Enter all keys lost options for Ford New Mondeo after 2016
2. Confirm whether the car is IMMO activated, and do it directly without IMMO (no need to power off the battery, etc.) If the vehicle has entered IMMO state, follow the steps below.

Disconnect the positive pole of the battery as prompted by the device, and then connect the vehicle battery with the GT105 power adapter cable, as shown in the figure below.

Warning: The positive wire harness should not be short-circuited with the car body.(GT105 internally implements PIN5 grounding, and PIN16 provides 12V power supply)

(Note: In the process of key matching, the external 12V power supply is always maintained, no need to disconnect) .

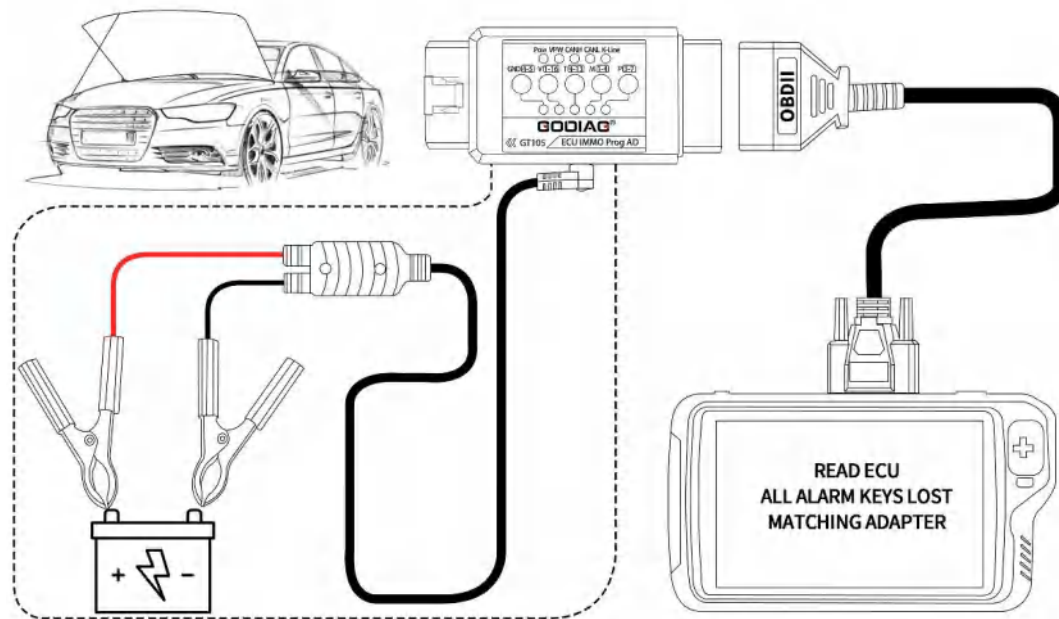
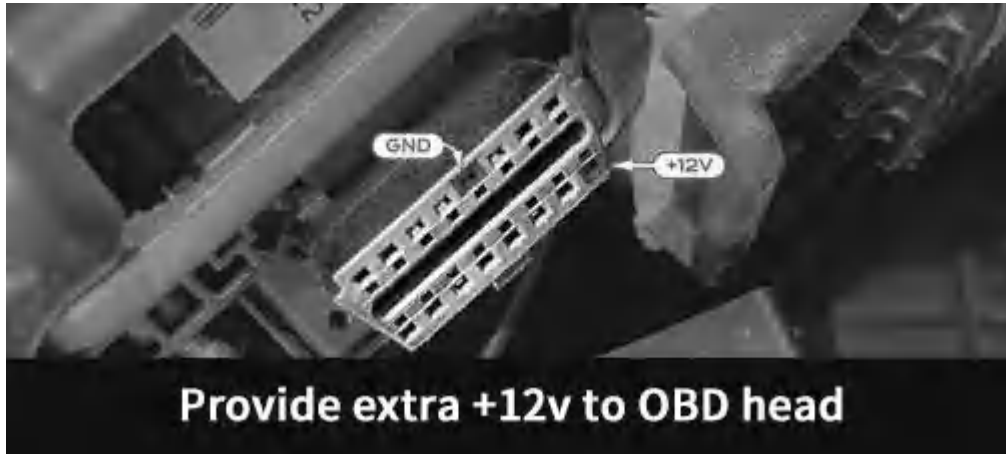

Follow the instructions on the Xhorse key tool plus pad to match the keys.

1. All car keys lost matching---wake up the meter or wake up the IMMO ECU.

A. Porsche and VW 4th-generation smart, 5th-generation card keys (models such as the new A6L Touareg A4, Q5, A7) light up the instrument, and the key matching tool is connected for data collection. Some vehicle instruments do not light up, but data collection can also be performed, such as: A6L, Q7(as the picture below shows).

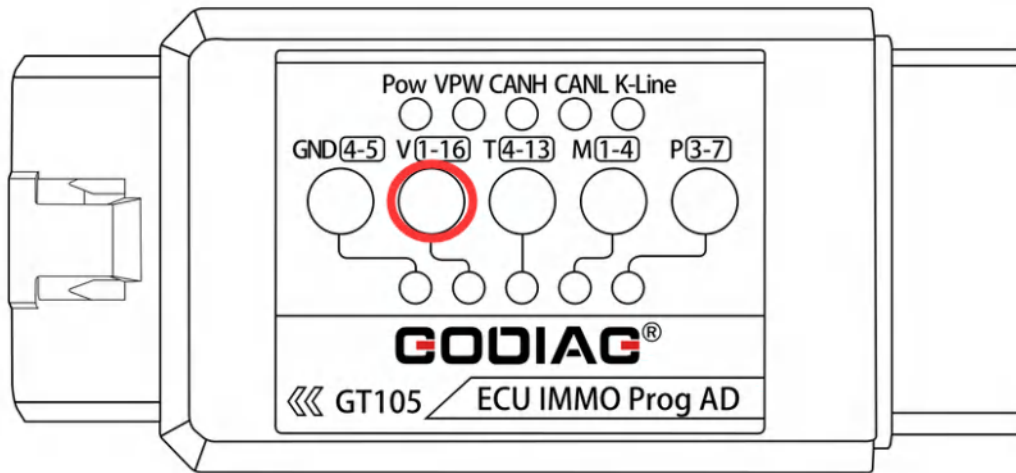

B. Toyota replaces the engine ECU, the IMMO ECU needs to be synchronized, or some key matching devices need to short-circuit PIN4-PIN13 to match the Toyota car all keys lost. Please press T4-13, the corresponding LED lights are on as shown below. (Note: Please keep the other buttons up.) Then insert the car OBD2 to complete the matching.

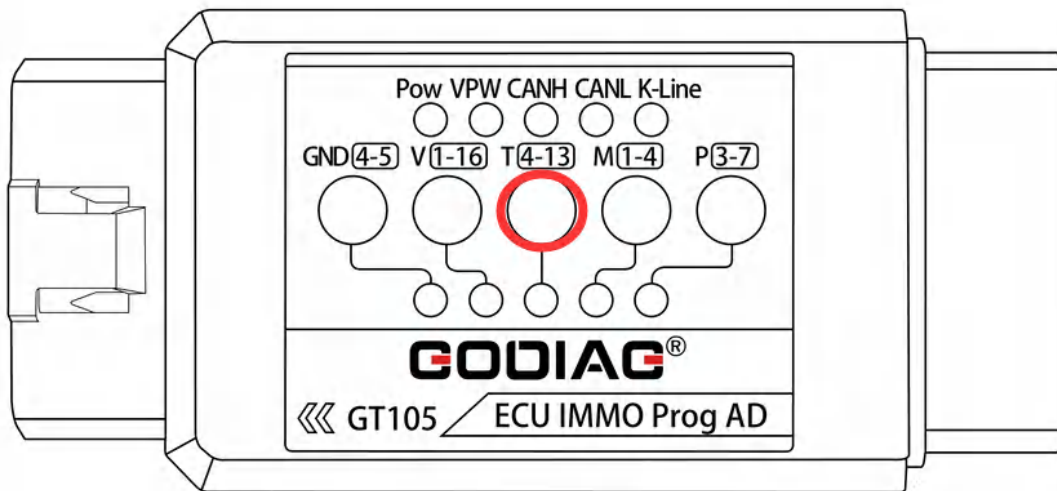

C. For all Mitsubishi key lost matching or remote matching, it is necessary to short-circuit PIN1-PIN4. Please press the M1-4 button, as shown in the figure below. (Note: Please keep the other buttons up.) Complete the remote control synchronization through other remote control matching devices.

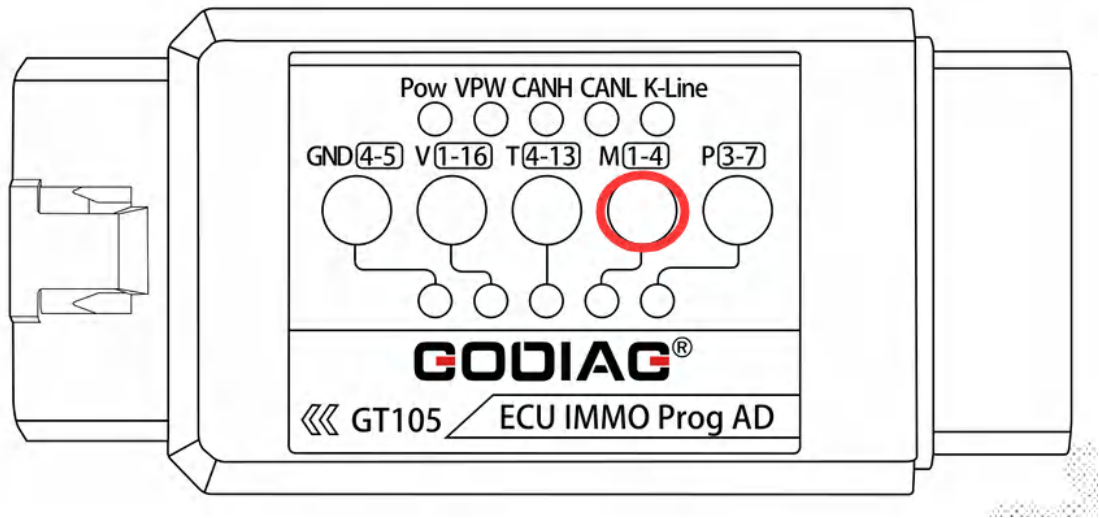

D. For the IMMO key learning of the old Porsche Cayenne, you need to short-circuit PIN3-PIN7 of the OBD2 diagnostic interface. Please press the M3-7 button, as shown in the figure below. (Note: Please keep the other buttons up.)

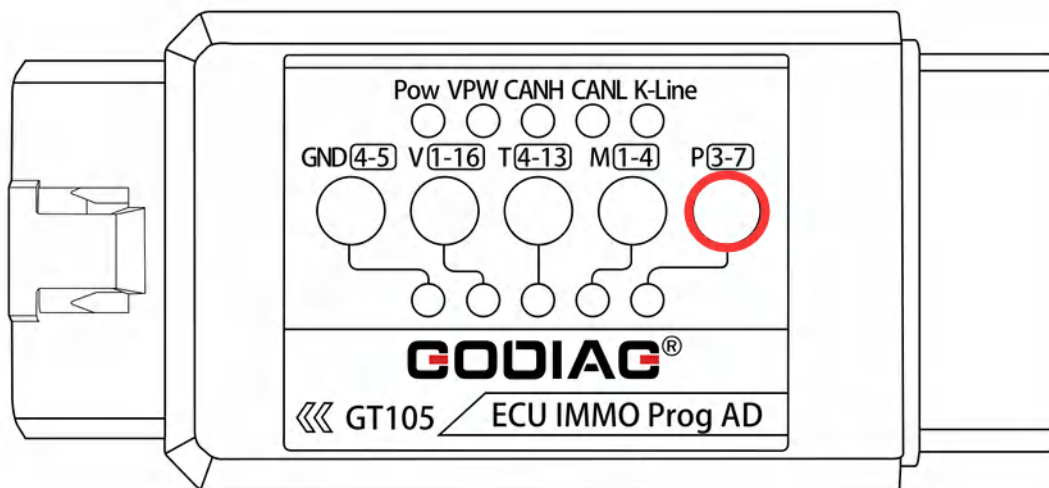

### 1. Outdoor operating power collection

When the locksmith ECU engineer cannot get 12V power supply in outdoor operation, he can use the GT105 power adapter cable to obtain 12V power supply from the car battery. (Realize on-site maintenance of outdoor faulty vehicles)

E.g:

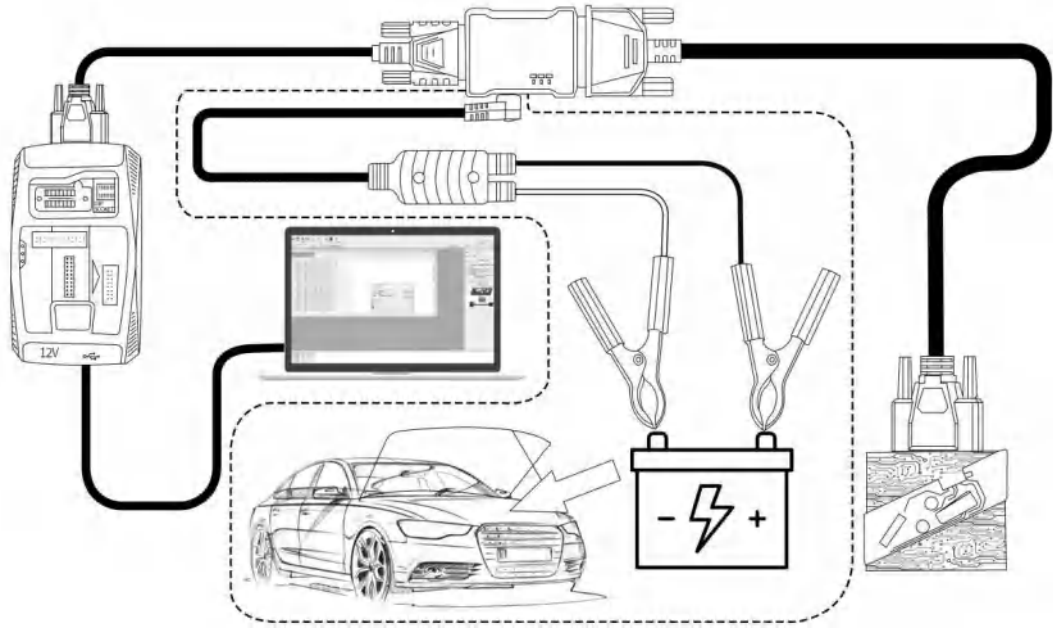

It can also be used with other programming tools for outdoor operation.

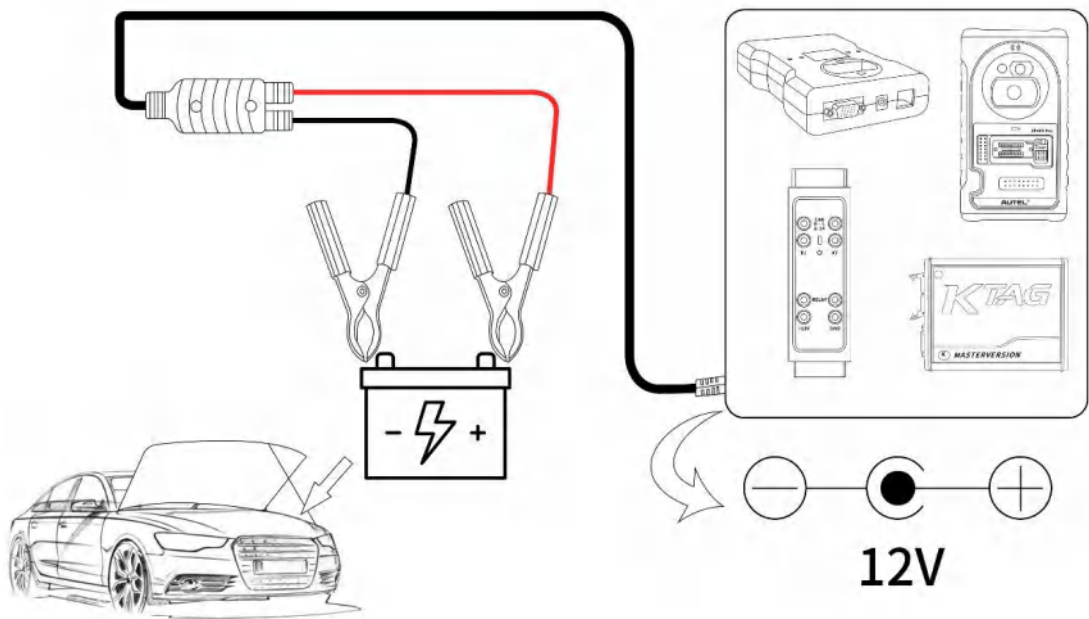

It can also supply power for 12V powered key cutters.



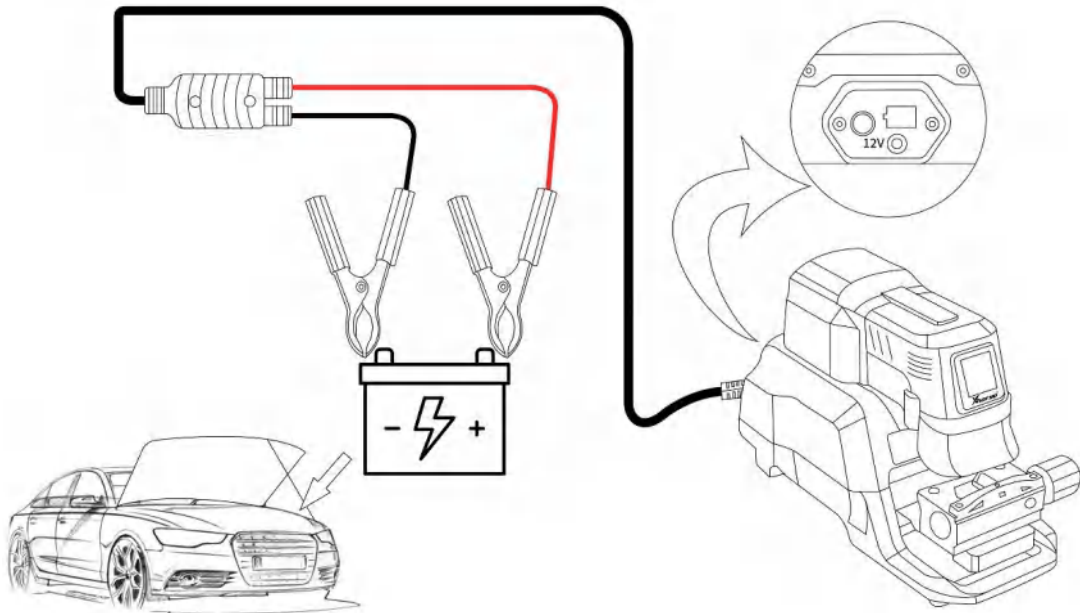

### Indicator Light Meaning

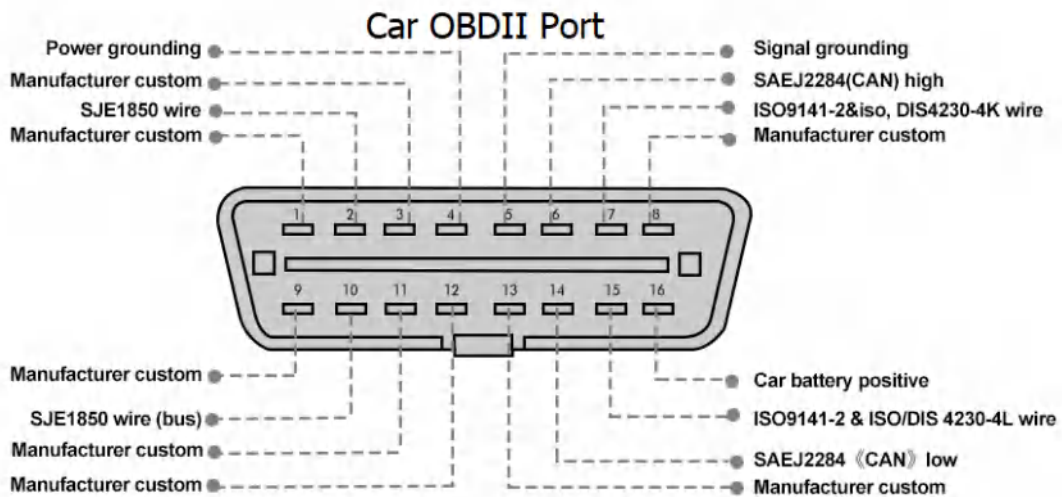

1. Manufacturer custom	9. Manufacturer custom
2. SJE1850 wire<bus+>	10. SJE1850 wire «bus->
3. Manufacturer custom	11. Manufacturer custom
4. Power grounding	12. Manufacturer custom
5. Signal grounding	13. Manufacturer custom
6. SAEJ2284 «CAN» high	14. SAEJ2284 «CAN» low
7. ISO9141-2&iso, DIS4230-4K wire	15. ISO9141-2 & ISO/DIS 4230-4L wire
8. Manufacturer custom	16. Car battery positive



A. The device provides a switch for independent OBD2 PIN4 PIN5. As shown in the figure, press the GND4-5 button and the corresponding LED light will light up to realize the short circuit between PIN4 and PIN5.

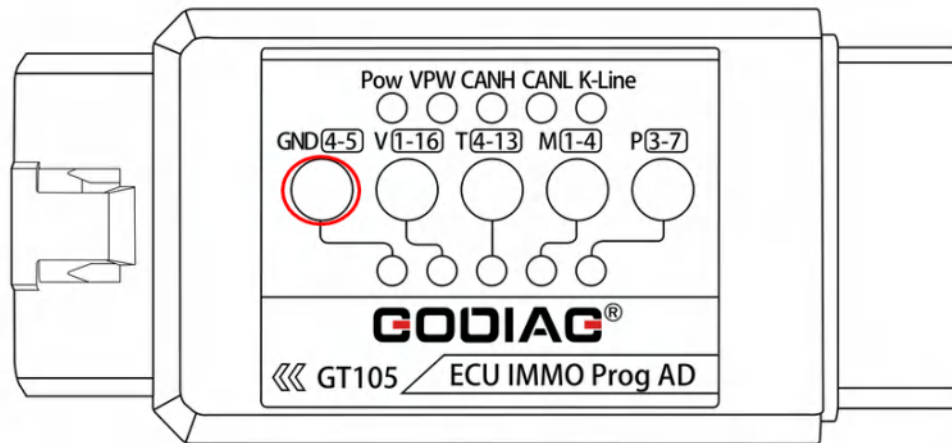

B. VPW, CANH, CANL, K-Line indicators on the device can provide data communication. These indicators above flashes when the diagnostic programming device sends a communication signal, which can be used to check if the device is sending a communication signal.

C. Equipped with ECU programming full protocol cable.  
(needs to be purchased separately)

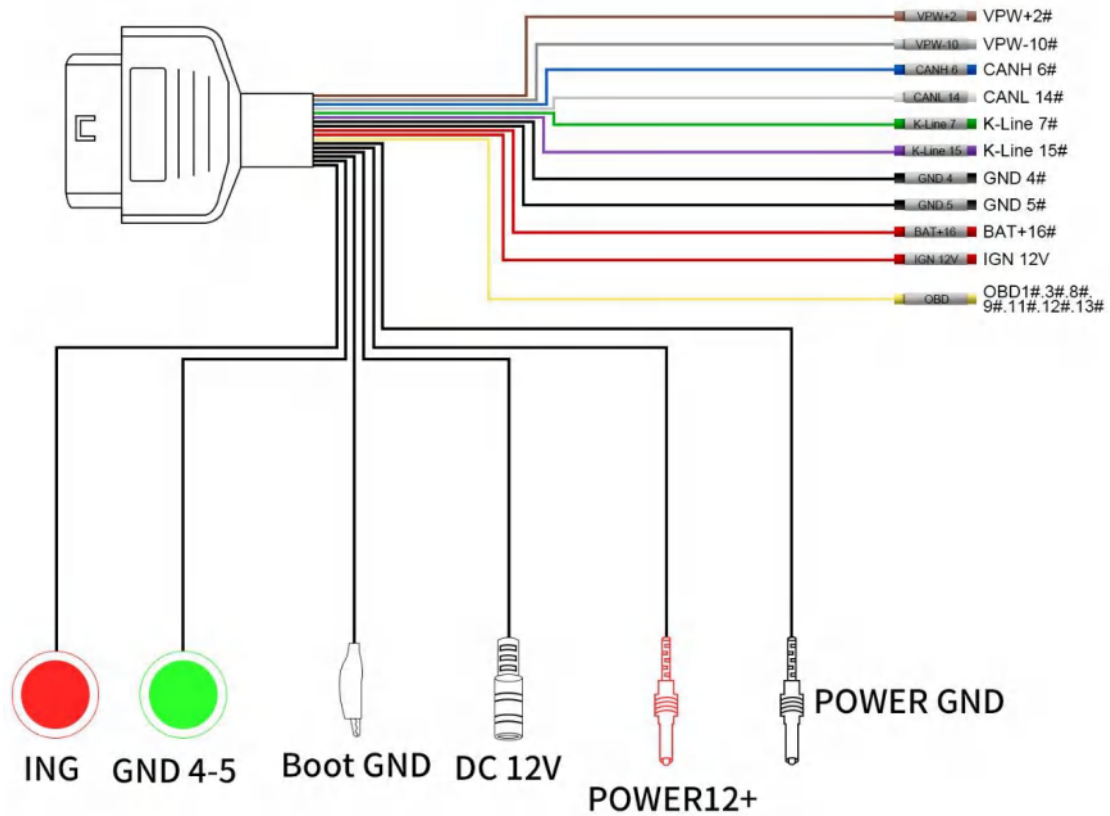

Standard OBD2 Independent Pin4, Pin5.

Press the GDN4-5 short-circuit button, the green light is on (press it down for normal use, and disconnect it when there is special need). With DC power interface, dedicated power plug. The BOOT GND connection clip is required to read the ECU. Equipped with ING ignition switch.

Standard OBD2, independent Pin4, Pin5, can cooperate with the device to obtain ECU data.

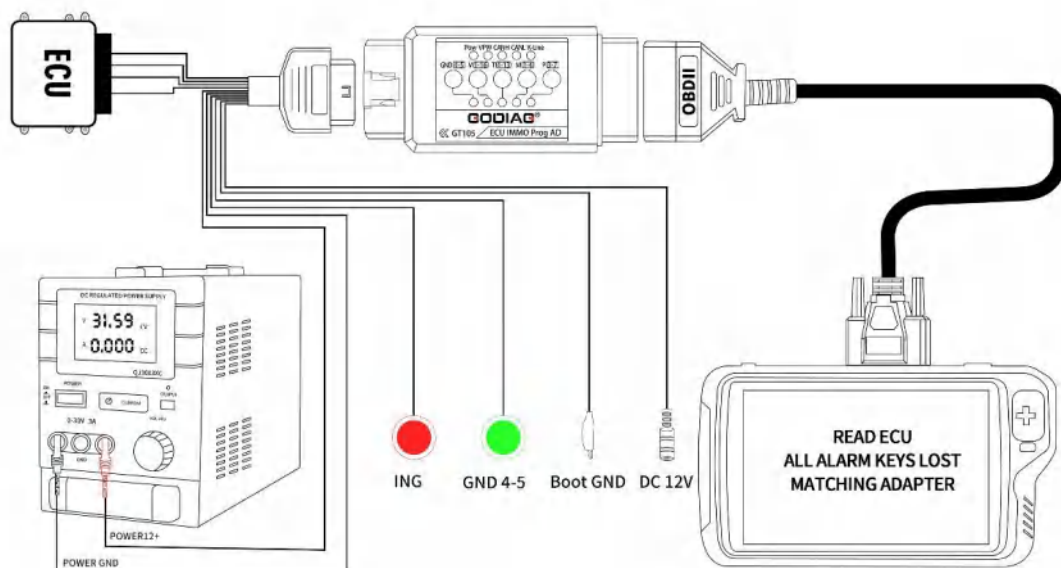

Use with ECU data reading and writing equipment

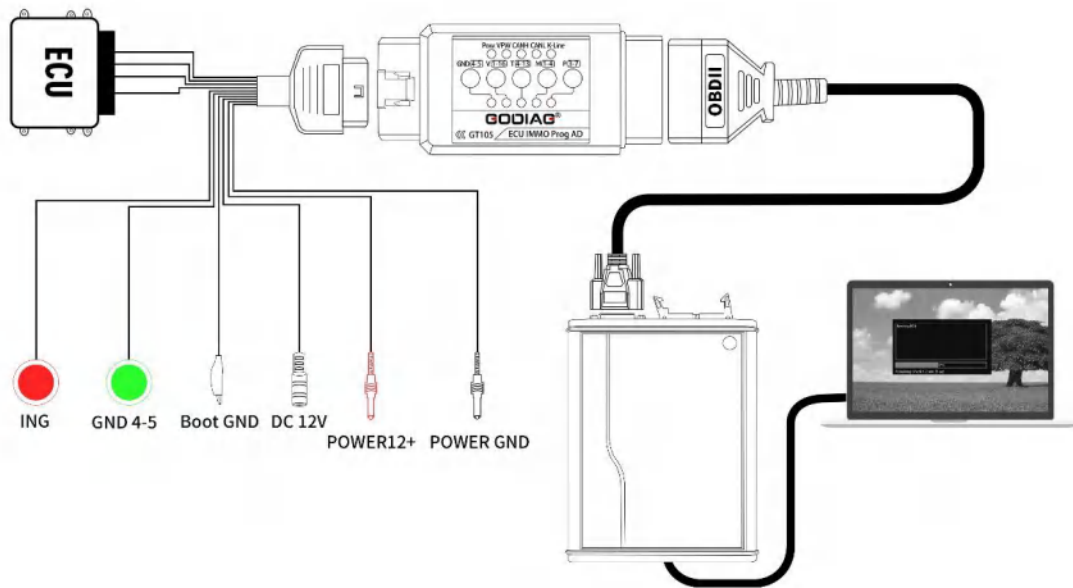

Cooperate with power adjustment equipment for data processing.

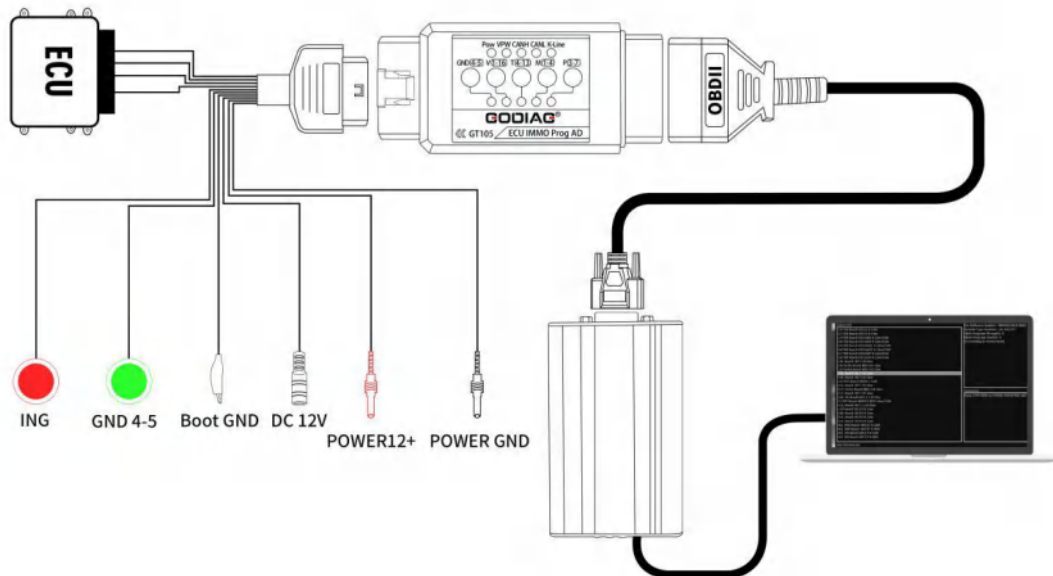

Accessories Features:

OBD2 pure copper female socket supports repeated insertion and removal, and has a long service life.

DC connector has a resettable 7A fuse.

Battery clip is treated with environmentally friendly salt spray with a thickness of 0.5 mm.

DC cable adopts 0.75m<sup>2</sup> 2-core sheathed cable and supports DC5.5\*2.5/ DC5.5\*2.1 interface.

**Accessories:**

GT105 host	1PC
Power cord with battery clip	1PC
Full protocol standard OBD2 cable.	1PC (needs to be purchased separately)



Shenzhen Sinoy Technology Co.,Ltd

All rights reserved.

[www.godiag.com](http://www.godiag.com)

+86 18813687743

[Sales@GoDiag.com](mailto:Sales@GoDiag.com)



Thanks for reading!