

Version: V1.00.000
Revised date: 09-08-2022

Trademarks

LAUNCH is a registered trademark of LAUNCH TECH CO., LTD. in China and other countries. All other marks are trademarks or registered trademarks of their respective holders.

Copyright Information

Copyright © 2022 by LAUNCH TECH CO., LTD. (also called LAUNCH for short). All rights reserved. No part of this publication may be reproduced, stored in a retrieval system, or transmitted in any form or by any means, electronic, mechanical, photocopying and recording or otherwise, without the prior written permission.

Statement: LAUNCH owns the complete intellectual property rights for the software used by this product. For any reverse engineering or cracking actions against the software, LAUNCH will block the use of this product and reserve the right to pursue their legal liabilities.

Disclaimer of Warranties and Limitation of Liabilities

All information, illustrations, and specifications in this manual are based on the latest information available at the time of publication.

The right is reserved to make changes at any time without notice. We shall not be liable for any direct, special, incidental, indirect damages or any economic consequential damages (including the loss of profits) due to the use of the document.

Using This Manual

This manual contains device usage instructions.

Some illustrations shown in this manual may contain modules and optional equipment that are not included in your system.

The following conventions are used.

Bold Text

Bold text is used to highlight selectable items such as buttons and menu options.

Example:

Tap **OK**.

Notes

A NOTE provides helpful information such as additional explanations, tips, and comments.

Example:

 Note: Remember to remove the VCI connector from the vehicle's DLC after use.

Warning

Warning indicates a hazardous situation which, if not avoided, could result in minor or moderate injury to the operator or to bystanders.

Example:

 Warning: Retrieving and using DTCs for troubleshooting vehicle operation is only one part of an overall diagnostic strategy. Never replace a part based only on the DTC definition. Each DTC has a set of testing procedures, instructions and flow charts that must be followed to confirm the location of the problem. This information can be found in the vehicle's service manual.

Danger

Danger indicates an imminently or potentially hazardous situation which, if not avoided, could result in death or serious injury to the operator or to bystanders.

Example:

 Danger: If you must drive the vehicle in order to perform a troubleshooting procedure, always have a second person help you. Trying to drive and operate the diagnostic tool at the same time is dangerous, and could cause a serious traffic accident.

Illustrations

Illustrations used in this manual are samples, the actual testing screen may vary for each vehicle being tested. Observe the menu titles and on-screen instructions to make correct option selection.

Important Safety Precautions

To avoid personal injury, property damage, or accidental damage to the product, read all of the information in this section before using the product.

DANGER

- When an engine is operating, keep the service area well-ventilated or attach a building exhaust removal system to the engine exhaust system. Engines produce various poisonous compounds (hydrocarbon, carbon monoxide, nitrogen oxides, etc.) that cause slower reaction time and result in death or serious personal injury.
- Please use the included battery and power adaptor. Risk of explosion if the battery is replaced with an incorrect type.
- If you must drive the vehicle in order to perform a troubleshooting procedure, always have a second person help you. Trying to drive and operate the diagnostic tool at the same time is dangerous, and could cause a serious traffic accident.

WARNING

- Always perform automotive testing in a safe environment.
- Do not connect or disconnect any test equipment while the ignition is on or the engine is running.

- Before starting the engine, put the gear lever in the Neutral position (for manual transmission) or in the Park (for automatic transmission) position to avoid injury.
- NEVER smoke or allow a spark or flame in vicinity of battery or engine. Do not operate the tool in explosive atmospheres, such as in the presence of flammable liquids, gases, or heavy dust.
- Keep a fire extinguisher suitable for gasoline/chemical/electrical fires nearby.
- Wear an ANSI-approved eye shield when testing or repairing vehicles.
- Put blocks in front of the drive wheels and never leave the vehicle unattended while testing.
- Use extreme caution when working around the ignition coil, distributor cap, ignition wires and spark plugs. These components create hazardous voltage when the engine is running.
- To avoid damaging the tool or generating false data, please make sure the vehicle battery is fully charged and the connection to the vehicle DLC (Data Link Connector) is clear and secure.
- Retrieving and using DTCs for troubleshooting vehicle operation is only one part of an overall diagnostic strategy. Never replace a part based only on the DTC definition. Each DTC has a set of testing procedures, instructions and flow charts that must be followed to confirm the location of the problem. This information can be found in the vehicle's service manual.
- Automotive batteries contain sulfuric acid that is harmful to skin. In operation, direct contact with the automotive batteries should be avoided. Keep the ignition sources away from the battery at all times.
- Keep the tool dry, clean, free from oil, water or grease. Use a mild detergent on a clean cloth to clear the outside of the equipment when necessary.
- Keep clothing, hair, hands, tools, test equipment, etc. away from all moving or hot engine parts.
- Store the tool and accessories in a locked area out of the reach of children.
- Do not use the tool while standing in water.
- Do not expose the tool or power adapter to rain or wet conditions. Water entering the tool or power adaptor increases the risk of electric shock.
- This tool is a sealed unit. There are no end-user serviceable parts inside. All internal repairs must be done by an authorized repair facility or qualified technician. If there is any inquiry, please contact the dealer.
- Keep the tool far away from magnetic devices because its radiations can damage the screen and erase the data stored on the tool.
- Do not attempt to replace the internal rechargeable lithium battery. Contact the dealer for factory replacement.
- Do not disconnect battery or any wiring cables in the vehicle when the ignition switch is on, as this could avoid damage to the sensors or the ECU.
- Do not place any magnetic objects near the ECU. Disconnect the power supply to the ECU before performing any welding operations on the vehicle.
- Use extreme caution when performing any operations near the ECU or sensors. Ground yourself when you disassemble PROM, otherwise ECU and sensors can be damaged by static electricity.
- When reconnecting the ECU harness connector, be sure it is attached firmly, otherwise electronic elements, such as ICs inside the ECU, can be damaged.

TABLE OF CONTENTS

1 Introduction..... 1

 1.1 Product Profile..... 1

 1.2 Package List..... 1

 1.3 Components & Controls 2

 1.3.1 Display Tablet 2

 1.3.2 VCI 4

 1.4 Technical Specifications..... 4

2 Initial Setup 6

 2.1 Charging the Tablet..... 6

 2.2 Screen Layout 6

 2.3 Adjusting Screen Brightness 6

 2.4 Changing Language..... 7

 2.5 Network Setup..... 7

3 Register & Update..... 8

 3.1 Register & Update 8

 3.2 Home screen..... 10

4 Connections 11

 4.1 Preparation..... 11

 4.2 Vehicle Connection 11

 4.3 Communication Setup..... 12

5 Diagnosis 13

 5.1 Intelligent Diagnose..... 13

 5.2 Local Diagnose 15

 5.2.1 Health report (Quick Test) 18

 5.2.2 System scan..... 20

 5.2.3 System selection 20

 5.2.4 ADAS calibration 26

 5.3 Remote Diagnose 26

 5.3.1 SmartLink Super Remote Diagnostics 26

 5.3.2 X431 Remote Diagnostics..... 28

 5.4 Diagnostic History 34

 5.5 Feedback 35

6 Service Function 37

 6.1 Oil Reset Service 37

 6.2 Electronic Parking Brake Reset 37

 6.3 Steering Angle Calibration 37

 6.4 ABS Bleeding 37

 6.5 Tire Pressure Monitor System Reset 37

 6.6 Gear Learning 38

 6.7 Anti-theft Matching 38

 6.8 Injector Coding 38

 6.9 Battery Matching 38

6.10 Diesel Particulate Filter (DPF) Regeneration	38
6.11 Throttle Matching	39
6.12 Gearbox Matching	39
6.13 AFS (Adaptive Front-lighting System) Reset	39
6.14 Sunroof Initialization	39
6.15 Suspension Calibration	39
6.16 EGR Adaption	39
6.17 Windows Calibration	39
6.18 Seats Calibration	39
6.19 Tyre Reset	40
6.20 Language Change	40
6.21 A/F Reset	40
6.22 Coolant Bleed	40
6.23 Transport Mode	40
6.24 AdBlue Reset (Diesel Engine Exhaust Gas Filter)	40
6.25 NOx Sensor Reset	40
6.26 Stop/Start Reset	40
7 Software Update	41
7.1 Update Diagnostic Software & APP	41
7.2 Update Frequently Used software	41
7.3 Renew Subscription	42
8 TPMS	43
9 ADAS	44
10 User Info	45
10.1 My Report	45
10.2 VCI	46
10.3 Activate VCI	46
10.4 Fix Connector Firmware/System	46
10.5 Sample	46
10.6 Vehicle Voltage	46
10.7 My Order	46
10.8 Subscription Renewal Card	46
10.9 Profile	46
10.10 Change Password	47
10.11 Settings	47
10.11.1 Units of measurement	47
10.11.2 Shop information	47
10.11.3 Printer set	47
10.11.4 Home screen display order	48
10.11.5 Clear cache	48
10.11.6 About	48
10.11.7 Diagnostic software auto update	48
10.11.8 Device Account Management	48
10.11.9 Login/Log out	49
10.12 Diagnostic Software Clear	49
11 Other Modules	51

11.1 Toolbox51

11.2 Tablet Setting51

11.3 Files.....51

11.4 Wireless Upgrade.....51

11.5 TeamViewer QS52

11.6 Recording Master52

11.7 Browser52

11.8 Camera52

11.9 Gallery52

11.10 Video Player52

11.11 E-Mail52

11.12 Calculator52

12 J2534 Reprogramming Using SmartLink C 53

 12.1 As a Local J2534 PassThru Device53

 12.2 As a Remote J2534 PassThru Device53

13 Synchronization..... 55

14 FAQ 56

1 Introduction

1.1 Product Profile

This Android OS-based, tablet-style diagnostic tool incorporates the best possible coverage of OE-level diagnostics with multitasking capable software.

Using the powerful 8-core 2.0GHz processor and a 10.1 inch sunlight readable capacitive touch screen with a resolution of 1920 x 1200 pixels, it delivers quick and complete diagnostic functionalities which technicians need to diagnose, research and repair vehicles in one solution.

It has the following features:

- **Intelligent Diagnose:** This module allows you to use the VIN information of the currently identified vehicle to access its data (including vehicle information, historical diagnostic records) from the cloud server to perform quick test.
- **Local Diagnose:** VINscan quick test and manual diagnosis are available. Diagnosis functions include: Read DTCs, Clear DTCs, Read Data Stream, Special Functions etc.
- **Remote Diagnosis:** This option aims to help repair shops or technicians launch instant messaging and remote diagnosis, making the repair job getting fixed faster.
- **Service Function:** All kinds of common maintenance and reset items including Oil lamp reset, DPF regeneration, ABS bleeding can be done.
- **One-click Update:** Lets you update your diagnostic software online.
- **Diagnostic History:** This function provides a quick access to the tested vehicles and users can choose to view the test report or resume from the last operation, without the necessity of starting from scratch.
- **Diagnostic Feedback:** Enables you to submit the vehicle issue to us for analysis and troubleshooting.
- **TPMS:** Configures the tool as a professional Tire Pressure Monitoring System (TPMS) service tool. It needs to work with the TSGUN device (sold separately) to perform all kinds of various TPMS functions.
- **ADAS:** This function enables users to perform ADAS (Advanced Driver Assistance System) calibration operations. It needs to work with the specific ADAS calibration tool (sold separately).
- **Pre- and Post- Repair Result Comparison:** By comparing the pre-repair and post-repair report, you can clearly determine which vehicle issues have been fixed and which remained unsolved.
- **Vehicle Coverage:** Quick dial to view the vehicle models that the tool covers.
- Equipped with USB port for working together with other add-on modules such as Oscilloscope, Sensor simulator, Battery tester and Videoscope.

1.2 Package List

Common accessories are same, but for different destinations, the accessories may vary. For detailed accessory items, please consult from the seller or check the packing list supplied with this tool together.

No.	Item	Description	Qt.
1	Display tablet	Indicates the test results.	1
2	VCI device	Connect to vehicle's DLC port to access vehicle's live data.	1
3	OBD II extension cable	Connect the VCI for extension purpose.	1
4	OBD I adaptor	Connect the non-16pin connector to the VCI.	1
5	Cigarette lighter cable	To supply power to the non-16pin connector through connection to the vehicle's cigarette lighter receptacle.	1

6	Battery clamps cable	To supply power to the non-16pin connector through connection to the vehicle's battery.	1
7	Power adaptors	Charges the tablet.	2
8	Data cable	Connects the VCI to the tablet to perform vehicle diagnosis.	1
9	Password envelope	A piece of paper bearing Product S/N and Activation Code, which is needed for product registration.	1
10	Scope Box kit	For detailed accessories, please check the package box.	Optional (Varies by product configuration)
11	Non-16pin adaptor cable kit	Connects to non-OBD II vehicle DLC port.	1

1.3 Components & Controls

There are two main components to the diagnostic system:

- Display Tablet – the central processor and monitor for the system (See Chapter 1.3.1).
- VCI – the device for accessing vehicle data (See Chapter 1.3.2).

1.3.1 Display Tablet

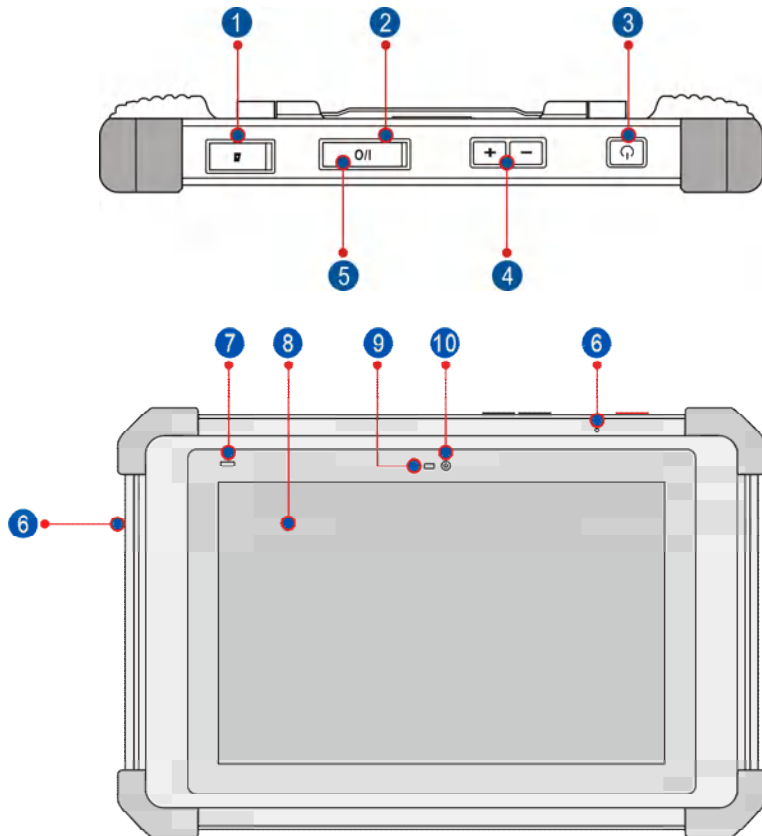

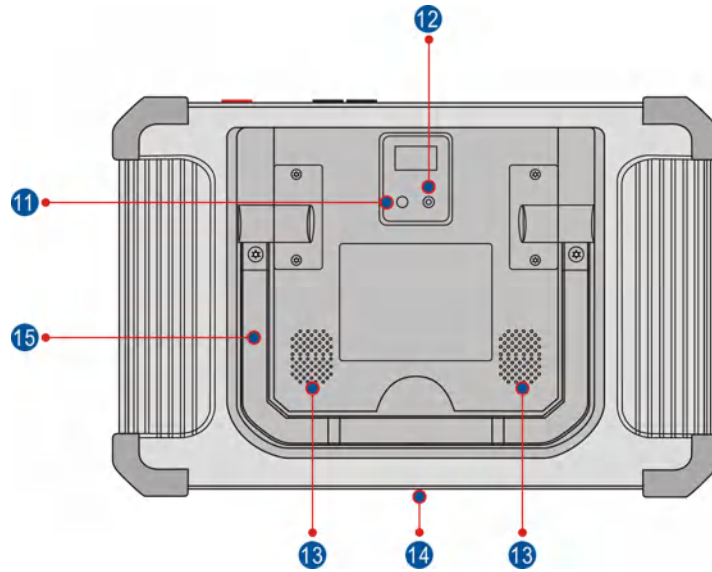

1. Memory Card Slot

Insert a memory card for storage extension.

2. Charging Port

Charge the tablet.

3. Power/Screen Lock Button

To turn the tablet on/off with long press, or lock the screen with short press.

4. Volume Buttons

Adjust the volume.

 Note: Press and hold [POWER] and [VOL -] key to capture the current screenshot.

5. USB Port

Reserved for add-on modules and other devices with similar port.

6. Microphone

Convert voice into an electrical signal.

7. Charging LED

It illuminates red while the tablet is charging. Once charging is finished, it will illuminate solid green.

8. Touch Screen

Indicate the test results.

9. Ambient Light Sensor

Sense the amount of the ambient light present.

10. Front Camera

Snapshot the view ahead the screen.

11. Rear Camera

Snapshot the view in front of the tablet.

12. Camera Flash

Produce a flash of artificial light.

13. Audio Speaker

Convert an electrical audio signal into a corresponding sound.

14. Charging Slot

Align it with the charging slot on the docking station to charge the tablet.

15. Adjustable Kickstand

Flip out it to any angle and work comfortable at your desk, or hang it on automotive part.

1.3.2 VCI

The SmartLink C device features powerful functions and it can be applied in the following situations:

- 1). When as a VCI (Vehicle Communication Interface), it needs to work in conjunction with the **Diagnose** module of the tablet, which is used to obtain vehicle data, and then send it to the tablet for analysis via Bluetooth / data cable.
- 2). When as a SmartLink C (Customer) dongle, it does not communicate with the tablet, but it needs to work together with the **SmartLink** module of the tablet. The tablet is mainly used to issue remote diagnostic requests, and the SmartLink C dongle is networked to receive and execute commands from the remote SmartLink B (Business).

 Note: For detailed operations, please refer to Chapter 5.3.

- 3). When as a local or remote J2534 PassThru device, it can be used in conjunction with the PC installed with OEM diagnostic software.

 Note: For detailed operations, please refer to Chapter 12.

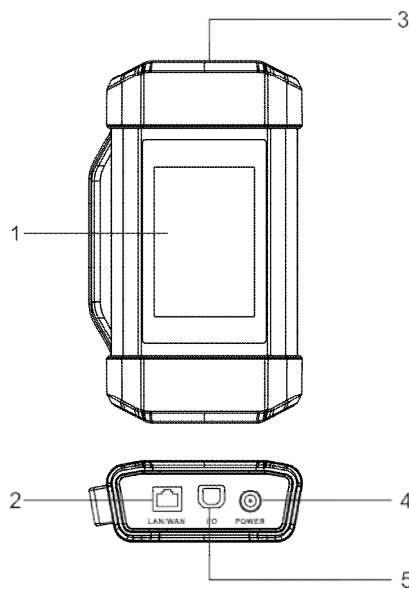

1. Touch screen

2. LAN/WAN port

Connect the SmartLink C device to the Internet via the crossover cable. It only applies to the SmartLink Super Remote Diagnostics.

3. OBD-16 diagnostic connector

Connect the SmartLink C device to the vehicle's DLC (Data Link Connector) port via the OBD II extension cable.

4. DC-IN power jack

Currently disabled and for manufacturer use only.

 **Warning:** The SmartLink C device obtains power through the vehicle's DLC, and it is prohibited to connect to an external DC power supply. No responsibility can be assumed for any damage or loss caused as a result of not strictly following the above method.

5. Data I/O port

- Connect the SmartLink C device to the tablet to perform vehicle diagnosis.
- Connect the SmartLink C device to the PC when as a J2534 PassThru device.

1.4 Technical Specifications

1. Display tablet

CPU: 8-core Processor, 2.0GHz

Display: 10.1 inch touch screen with a resolution of 1920 x 1200

Memory: 4GB

Hard disk: 64GB

Connectivity:

- Wi-Fi (802.11 b/g/n/ac)
- Universal serial BUS Ports (1 x Type-C + 1 x Type-A)

Camera: 8MP front-facing camera + 13MP rear-facing camera

Sensor: Gravity Accelerometer + 3-Axis Acceleration Sensor

Operating Temperature: 0°C ~ 50°C

Storage Temperature: -20°C ~ 70°C

2. VCI (Vehicle Communication Interface)

Size: 204mm x 110mm x 45mm

Working voltage: DC 9~36V

Power consumption: ≤ 6W

Communication: Bluetooth/Wi-Fi or data cable connection

Working temperature: 0°C ~ 50°C



2 Initial Setup

2.1 Charging the Tablet

Notes:

- Only use the included power adaptor to recharge the tablet. Use of any other adaptor will damage the tool. We assume no responsibility for damage or loss resulting from using other similar adaptors other than the specified one.
- Always charge on a non-flammable surface in a well-ventilated area.

To check the battery power level, press and hold the Power button about 3 seconds to turn on the tablet. Power level is indicated as a percentage in the upper right corner of the screen. If the power level drops below 10% while the tablet is on, a “Connect Charger” notification will appear on the screen.







1. Connect one end of the power adaptor to charging port of the tablet, and the other end to the AC outlet.
2. The charging LED illuminates solid red and the charging symbol  will appear on the screen.
3. Once it illuminates solid green, it indicates that the battery is fully charged and the charging complete symbol  replaces the charging symbol. Disconnect the power adaptor from the AC outlet.
4. Press and hold the **POWER** button for about 3 seconds to turn on the tablet. The system starts initializing and then enters the home screen.

To turn the tablet off, press and hold the **POWER** button until an option menu appears. Tap **Power Off**.

2.2 Screen Layout

On-screen keys and status bar on the bottom of the screen are as follows:



- | | |
|---|--|
| 1 | Tap  to visit the official website. |
| 2 | Tap  to capture the current screen and all captured screenshots are stored in the Screenshots folder. |
| 3 |  shows whether the VCI is connected properly or not. |
| 4 | Tap  to display a list of applications that are currently running or recently used. Tap certain application to open it. Swipe it upwards to close it. |
| 5 | Tap  to jump to the home screen. |
| 6 | Tap  to return to the previous screen or exit the application. |

2.3 Adjusting Screen Brightness

The tablet is equipped with a built-in light intensity sensor. It can adjust the screen brightness according to the ambient light intensity automatically. Alternatively, you can also adjust it manually.

1. On the home screen, tap **Other Modules -> Tablet Settings -> Display -> Brightness level**.
2. Drag the slider to adjust it.

Alternatively, user may also slide the **Automatically brightness** switch to ON, and the system will automatically adjust the screen brightness.

 Note: Reducing the brightness of the screen is helpful to save the power of the tablet.

2.4 Changing Language

The tablet supports multiple languages. To change the language of the tablet, please do the following:

1. On the home screen, tap **Other Modules -> Tablet Settings -> Language & input -> Language**.
2. Tap the desired language from the list and the system will change to the chosen language.

2.5 Network Setup

The tablet has built-in Wi-Fi that can be used to get online. Once you're online, you can register the tablet, browse the Internet, get and update apps and send email on your network.

 Note: Once WLAN is set as ON, the tablet will consume more power. While WLAN keeps unused, please turn it off to conserve battery power.

1. On the home screen, tap **Other Modules -> Tablet Settings -> WLAN**.
2. Tap or slide the Wi-Fi switch to ON, the tablet starts searching for all available wireless LANs.
3. Choose the desired Wi-Fi access point / network,
 - If the network you chose is open, you can connect directly.
 - If the selected network is encrypted, you have to enter the right security key (network password).

When this tool is in range, it will connect to the previously linked network automatically.

3 Register & Update

For new users, you will need to experience a user registration process before getting started.

3.1 Register & Update

After the tablet is initialized, tap the **Login** button on the upper right corner of the screen, the following screen will appear:



(If you are a new user, follow **A** to proceed.)

(If you have registered to be a member, go to **B** to login the system directly.)

(In case you forgot password, refer to **C** to reset a new password.)

A. If you are a new user, tap **New Registration** to enter sign-up page.

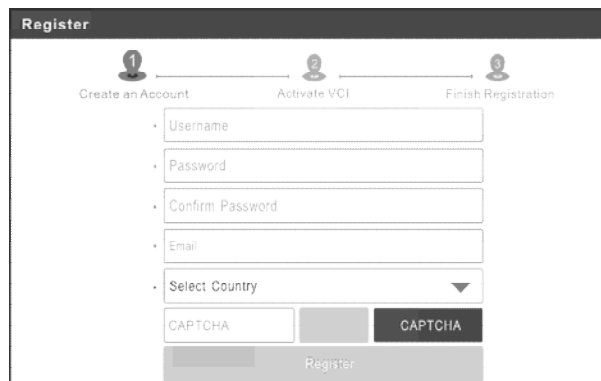

1. Create an App Account: Input the information to create a new account (all fields must be completed). When finished tap **Register**, the following screen will appear:

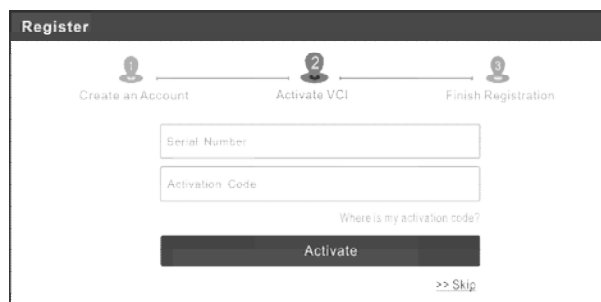

2. Activate VCI: Input the Product Serial Number and Activation Code, and tap **Activate** to go to the next step.

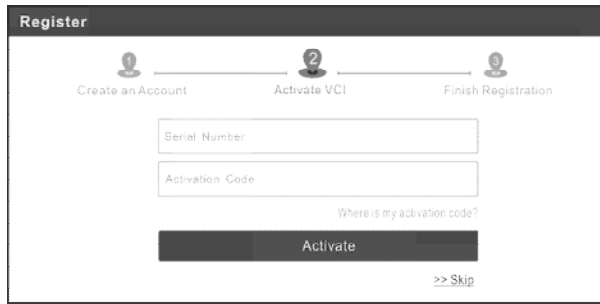

Input the Product Serial Number and Activation Code can be found in the supplied Password Envelope.

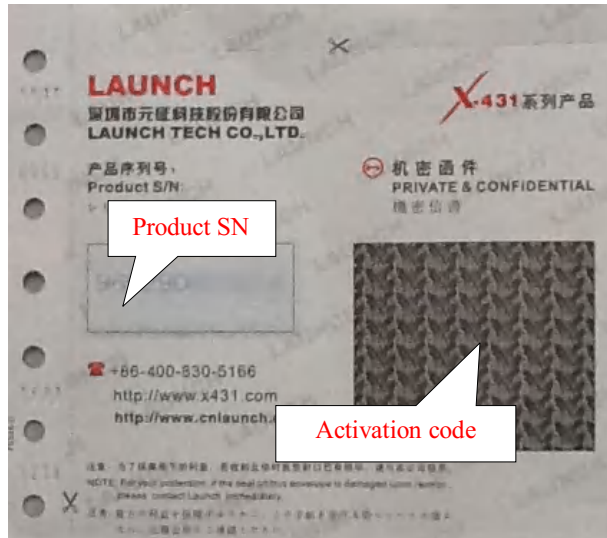

*Note: To exit and activate it later, tap **Skip**. In this case, you can activate the VCI by tapping **User Info -> Activate VCI**.

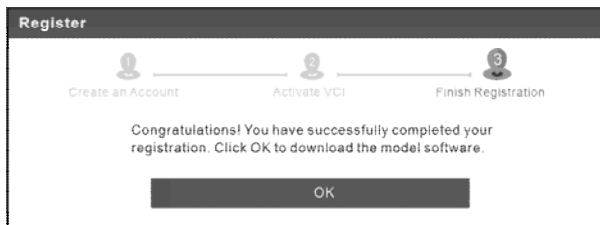

3. Finish Registration: Tap **OK** to navigate to the download page and download the diagnostic software.

On the download page, tap **Update** to start downloading. To pause downloading, tap **Stop**. Once download is complete, the system will install the software package automatically.

*Note: When downloading the diagnostic software or checking for updates, make sure the tablet has a strong Wi-Fi connection. It may take a long time to finish it, please be patient to wait.

B. If you have registered to be a member, input your name and password, and then tap the **Login** button to enter the main menu screen directly.

*Note: The tablet has an auto-save function. Once the username and password are correctly entered, the system will automatically store it. After initial setup, it is no longer necessary to input the account information manually to log in.

C. If you forgot the password, tap **Retrieve password** and then follow on-screen instructions to set a new password.

3.2 Home screen

It mainly includes the following items:

Name	Description
Intelligent Diagnose	This module allows you to obtain vehicle data from the cloud server to perform quick test via reading VIN, which provides a perfect solution to various defects resulting from step-by-step menu selection. In addition, user can also check the historical repair records online through this module.
Local Diagnose	Diagnose a vehicle manually.
Service Function	It offers coding, reset, relearn and more service functions, to help vehicles get back to functional status after repair or replacement.
Remote Diagnose	There are two remote diagnostics platforms available: SmartLink Super remote diagnostics solution and X-431 Remote Diagnostics.
TPMS	Configures this tool as a professional TPMS (Tire Pressure Monitoring System) service tool. It provides the ability to activate tire pressure information, program tire pressure sensor and perform the TPMS relearning functions etc. It needs to work with the X-431 TSGUN device (sold separately) to perform all kinds of various TPMS functions.
Software Update	Update vehicle diagnostic software and APK.
Diagnostic History	Generally once a vehicle diagnosis is performed, the tablet will automatically save every details of diagnostic process. This function provides a quick access to the tested vehicles and users can resume from the last operation, without starting from scratch.
Feedback	Feedback the recent 20 diagnostic logs to us for issue analysis.
ADAS	This function enables users to perform ADAS (Advanced Driver Assistance System) calibration operations. The ADAS calibration software is disabled by default. Before using this function, users must activate the ADAS function using the ADAS Activation Card.
Mall	An online diagnostic software store. This module enables you to subscribe some extra software or service functions that are not integrated in the tool online.
Vehicle Coverage	Check the vehicle models that the tool covers.
Info Center	Includes the tool information (user manual and FAQ), general information (training videos, product catalogue etc) and repair information (DTC help and technology handbook).
User Info	Manage VCI, diagnostic reports & records, change password, configure printer, sample data and logout / login etc.
Other Modules	Include the add-on modules and some frequently used built-in apps.

4 Connections

4.1 Preparation

- The ignition is turned on.
- The vehicle battery voltage range is 9-14V or 18-30V.
- The throttle is in closed position.
- Find DLC location:

For passenger cars, the DLC(Data Link Connector) is usually located 12 inches from the center of the instrument panel, under or around the driver’s side for most vehicles. For some vehicles with special designs, the DLC location may vary. Refer to the following figure for location.

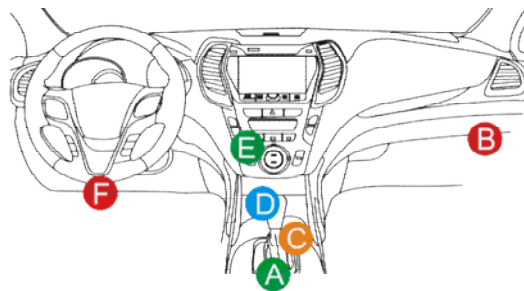

A. Opel, Volkswagen, Audi

B. Honda

C. Volkswagen

D. Opel, Volkswagen, Citroen

E. Changan

F. Hyundai, Daewoo, Kia, Honda, Toyota, Nissan, Mitsubishi, Renault, Opel, BMW, Mercedes-Benz, Mazda, Volkswagen, Audi, GM, Chrysler, Peugeot, Regal, Beijing Jeep, Citroen and other most popular models

If the DLC cannot be found, refer to the vehicle’s service manual for the location.

For commercial vehicles, the DLC is always located in driver’s cab.

4.2 Vehicle Connection

The method used to connect the VCI device to a vehicle’s DLC depends on the vehicle’s configuration as follows:

For OBD II vehicles, connect the SmartLink C to vehicle’s DLC directly via the OBD II extension cable.

For non-OBDII vehicles, proceed as follows:

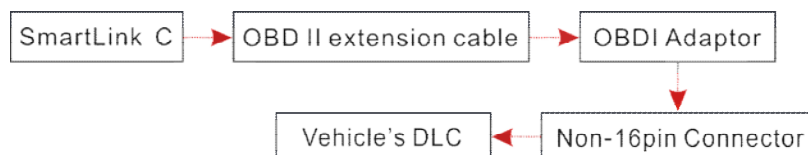

Note: If the power supply on vehicle diagnostic socket is insufficient or the power pin is damaged, you can get power via either of the following ways:

- Via Battery clamps cable (optional): Connect one end of the battery clamps cable to the power jack of the OBD I adaptor box, and the other end to the vehicle’s battery.
- Via Cigarette lighter cable (optional): Connect one end of the cigarette lighter cable to the power jack of the OBD I adaptor box, and the other end to the cigarette lighter receptacle.

4.3 Communication Setup

There are two kinds of ways available for the tablet to communicate with the VCI device: Wi-Fi and USB cable.

The USB cable connection is a simple & quick way to establish communication between the tablet and the VCI. After properly connecting the USB cable from the tablet to the VCI, the VCI navigation button at the bottom of the screen will be enabled indicating the USB connection is successful.

 Note: The USB connection provides the most stable and fastest communication. When all communication methods are applied at the same time, the tablet will use the USB communication as the default priority.

5 Diagnosis

5.1 Intelligent Diagnose

Through simple Wi-Fi communication between the tablet and VCI, you can easily get the VIN (Vehicle Identification Number) information of the currently identified vehicle. Once the VIN is successfully identified, the system will retrieve it from the remote server and then guide you to vehicle information page without performing the step-by-step manual menu selection.

The vehicle information page lists all historical diagnostic records of the vehicle, which lets the technician have a total command of the vehicle faults. In addition, a quick dial to Local Diagnose and diagnostic function are also available on this page for reducing the roundabout time and increasing productivity.

Notes:

- Before using this function, please make sure the VCI is properly connected to the vehicle's DLC port. For detailed connection, see Chapter 4.2.
- A stable network connection is required for this function.

Follow the steps below to proceed.

1. Tap **Intelligent Diagnose**, the following screen will appear.



2. After pairing is complete, the tablet starts reading the vehicle VIN.

- A. If the VIN can be found from the remote server database, the following screen will appear:

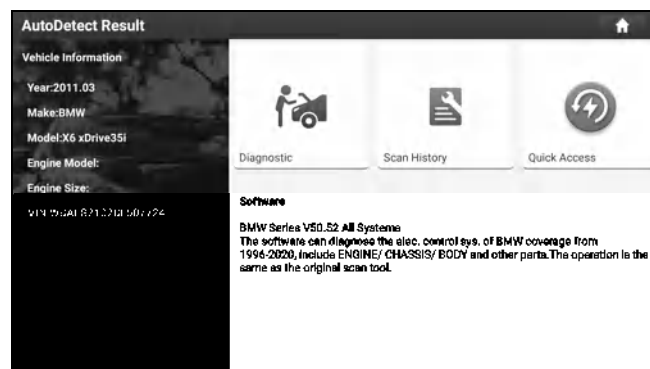

- Tap **Diagnostic** to start a new diagnostic session.
- To perform other functions, tap **Quick access** to directly go to the diagnostic function selection screen. Choose the desired one to start a new diagnostic session.
- Tap **Scan History** to view its historical repair record. If there are records available, it will be listed on the screen in sequence of date. If no records exist, the screen will show *No Record*.



- Tap **View record** to view the details of the current diagnostic report.
- To perform other functions, tap **Quick access** to directly go to the diagnostic function selection screen. Choose the desired one to start a new diagnostic session.

B. If the tablet failed to access the VIN information, the following screen will appear:



- Tap the input field to directly, tap **OK**. If the VIN exists on the remote server, the system will enter the diagnostic function selection screen.
- Tap to launch the VIN recognition module.

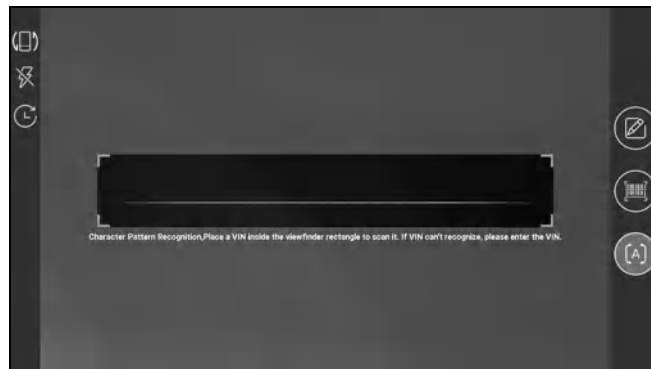

Place the VIN inside the viewfinder rectangle to scan it. The most recognizable location for this number is in the top left corner on the vehicle's dashboard. Other locations include the driver's door or post, and the firewall under the hood.

- Tap to switch the display mode of the screen.
- Tap to turn the camera flash on.
- Tap to choose it from the record list if the VIN of the vehicle has been scanned before.
- Tap to input the VIN manually if the tablet has failed to identify the VIN of the vehicle.
- Tap to scan the VIN barcode. If the VIN barcode cannot be recognized, please manually input the VIN.
- Tap to scan the VIN character. If the VIN character cannot be recognized, please manually input the VIN.

Note: In general, vehicle identification numbers are standardized - all contain 17 characters. VIN characters may be

capital letters A through Z and numbers 1 through 0; however, the letters I, O and Q are never used in order to avoid mistakes of misreading. No signs or spaces are allowed in the VIN.

After scanning, the screen automatically displays the result.

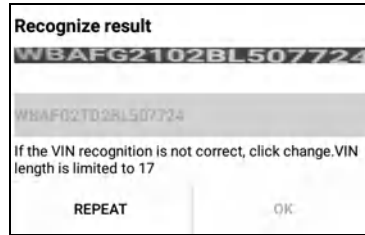

- If the VIN scanned is incorrect, tap the result field to modify it and then tap **OK**.
- To scan it again, tap **REPEAT**.

If the VIN exists on the remote server, the system will enter the diagnostic function selection screen.

5.2 Local Diagnose

Tap **Local Diagnose** to enter the vehicle selection page.

2 approaches are provided for you to access the vehicle diagnostic software. Choose any one of the following ways:

1. VINSKAN enables you to access it more quickly.

Tap **VINScan**, the following screen will appear:

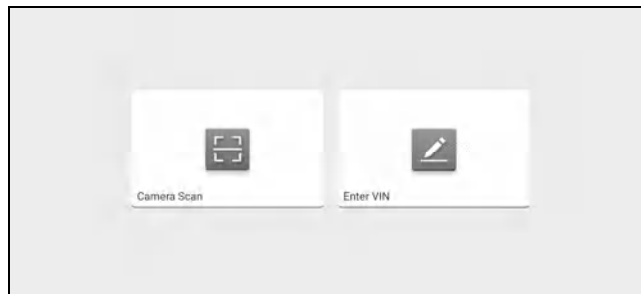

In this case, camera scan and enter VIN are available.

A. Camera Scan: In this mode, the VCI should be connected to the vehicle's DLC port first, and then a wireless communication should be established between the tablet and the VCI.

Tap **Camera Scan**, the following screen will appear:

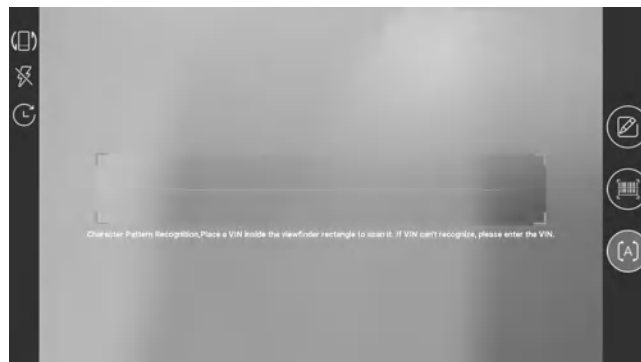

Place the VIN inside the viewfinder rectangle to scan it.

After scanning, the following screen will appear.

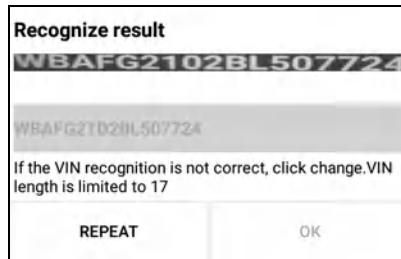

If the VIN scanned is incorrect, tap the result field to modify it and then tap **OK**. If the VIN exists on the remote server, the system will navigate to the diagnostic function selection screen directly.

Tap the desired option to perform the corresponding diagnostic function.

Note: Before using this function, the corresponding diagnostic software and Auto search file need to be downloaded on your tool first while downloading the diagnostic software.

B. INPUT VIN: In this mode, you can input the vehicle VIN manually. In general, the vehicle identification numbers are standardized - all contain 17 characters. VIN characters may be capital letters A through Z and numbers 1 through 0; however, the letters I, O and Q are never used in order to avoid mistakes of misreading. No signs or spaces are allowed in the VIN.

Tap **Enter VIN**, the following screen will appear.



Input the VIN, and tap **OK**, the tablet will automatically identify the vehicle model and directly navigate to the diagnostic function selection menu.

2. Tap a corresponding diagnostic software logo, and then follow the on-screen instruction to access the diagnostic software.

Take Demo (V15.21) as an example to demonstrate how to diagnose a vehicle.

1). Select diagnostic software version: Tap the **DEMO** to go to Step 2.



On-screen Buttons:

Vehicle Coverage: Tap to view the vehicle models that the current diagnostic software covers.

What's new: Tap to view the optimized items and enhancements.

Introduction: Tap to check the software function list.

Note: Tap to read some precautions on using the current diagnostic software.

OK: Tap it to go to next step.

The diagnostics toolbar contains a number of buttons that enable various procedures. It is displayed at the top of the vehicle diagnostic screen throughout the whole diagnostic session. Refer to the table below for a brief description of the functions of the diagnostics toolbar buttons:

 **Home:** Return to the home screen.

 **Print:** Tap to print the selected screenshots out via external printer. The printer needs to be configured separately. For details on printer setting, refer to Chapter 10.11.3.

 **Exit:** Exit the diagnostic application.

2). Select vehicle model (varies with different versions): Select the desired vehicle model. Here we take **Ford** for example to demonstrate how to diagnose a vehicle.



3). Read vehicle information: After reading the vehicle information, double check if the vehicle information is correct or not. If yes, tap **Yes** to continue.

4). Select test item: Select the desired test item to proceed.

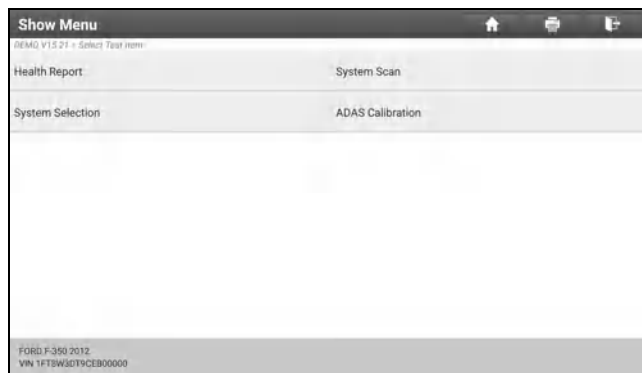

5). Turn the ignition key to ON: Set the ignition switch to on.

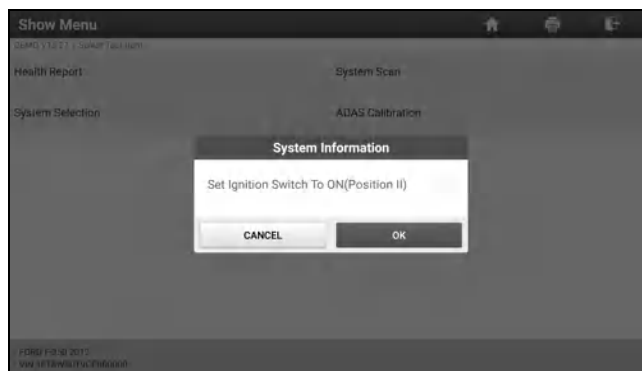

5.2.1 Health report (Quick Test)

This function varies from vehicle to vehicle. It enables you to quickly access all the electronic control units of the vehicle and generate a detailed report about vehicle health.

On the test item selection screen, tap **Health Report** and turn on the ignition switch, the system will start scanning the ECUs. Once the scanning process is complete, the following screen will appear:



The tested system with fault code appears in red and the system with OK displays in green (normally).

Note: Diagnostic Trouble Codes or Fault Codes can be used to identify which engine systems or components that are malfunctioning. Never replace a part based only on the DTC definition. Retrieving and using DTCs for troubleshooting vehicle operation is only one part of an overall diagnostic strategy. Follow testing procedures (in vehicle’s service manual), instructions and flowcharts to confirm the locations of the problem.

On-screen Buttons:

Enter: Tap to enter the diagnostic function selection screen.

(Search): Highlight certain diagnostic trouble code and tap it to retrieve it in the search engine.

Report: Tap to save the diagnostic result as a health report.

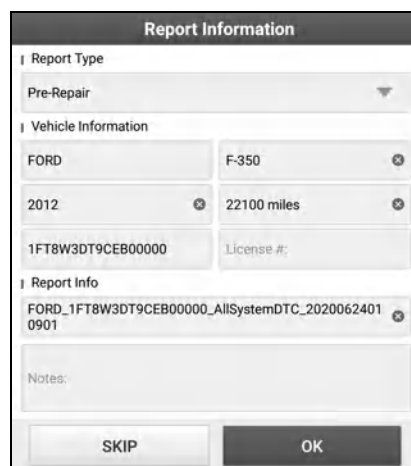

Note: Diagnostic report is classified into three categories: Pre-Repair report, Post-Repair report and Diagnostic Scan. No matter which type you saved the report as, the report type will be appended as a tag on the upper right corner of the diagnostic report for easier identification.

Tap ▼ to select the report type from the option list and input the required information, and then tap **OK**.

Note: To facilitate the comparison of the pre-repair and post-repair reports and get accurate test result, please make sure you saved the right type of the diagnostic report.

To save the report as a common diagnostic report, select **Diagnostic Scan**.

Note: For workshop information, tap the input box to enter it. Alternatively you can also set it in **User Info -> Settings -> Shop Information**.

Once you configured the information, it will be automatically generated every time you saved the diagnostic report. All vehicle and workshop information will be appended as tags on the diagnostic report.

To ignore the workshop information, tap **Skip** to go to the report details screen.



On the report details screen, tap **Save** to save it. All diagnostic reports are saved in **User Info -> My Report -> Health Report**.

Help: Tap to view the help information of the selected DTC item.

Compare Results: Tap to select the pre-repair report to compare. By comparison of the pre- and post- repair reports, you can easily identify which DTCs are cleared and which remain unfixed.

DTC	Post	Pre
PCM (Powertrain Control Module)		
P0401 EGR Valve A Flow Insufficient Detected	Cleared	Found
P1291 Injector High Side Short To GND Or VBATT (Bank1)	Cleared	Found
P2073 Manifold Absolute Pressure/Mass Air Flow-Throttle correlation at idle	Cleared	Found

- **Post** indicates DTC status of post-repair.
- **Pre** indicates DTC status of pre-repair.

Note: Before performing this function, please make sure that:

- You have saved a pre-repair report of the currently tested vehicle, and
- You have already made some repairs and service and cleared the DTCs after the pre-repair reported is generated. Otherwise, no differences exist between the pre- and post- repair reports.

Clear DTCs: Tap to clear the existing diagnostic trouble codes.

 Note: Clearing DTCs does not fix the problem(s) that caused the code(s) to be set. If proper repairs to correct the problem that caused the code(s) to be set are not made, the code(s) will appear again and the check engine light will illuminate as soon as the problem that cause the DTC to set manifests itself.

5.2.2 System scan

This option allows you to quickly scan which systems are installed on the vehicle.

On the test item selection screen, tap **System Scan**, the system start scanning the systems. Once the scanning process is complete, the following screen will appear.



Tap the desired system to go to the diagnostic function selection screen. For detailed operations on diagnostic function, please refer to Chapter 5.2.3.

5.2.3 System selection

This option allows you to manually select the test system and function step by step.

On the test item selection screen, tap **System Selection**, the screen displays as follows:

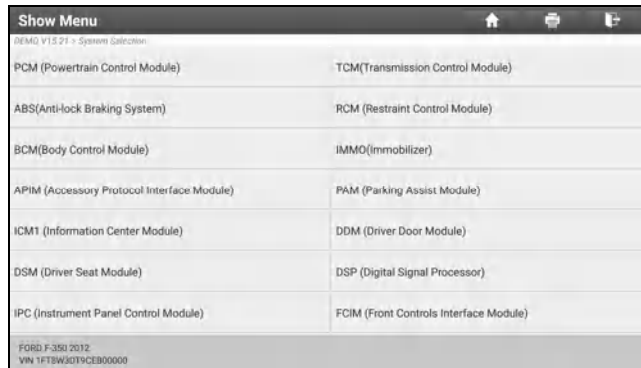

Swipe the screen from the bottom to view the vehicle system on the next page.

Tap the target system (take **ECM** for example) to navigate to the diagnostic function selection screen.

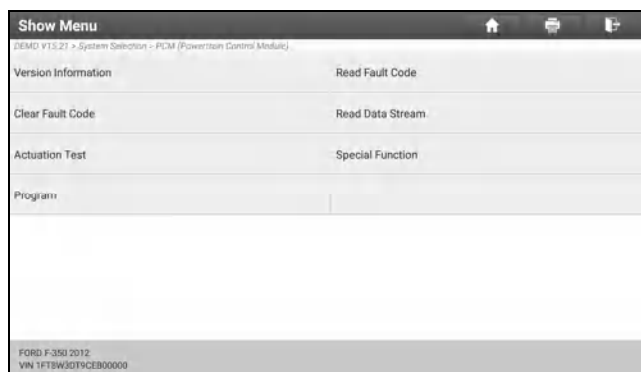

 Note: Different vehicle has different diagnostic menus.

A. Version Information

This function is used to read the version information of system mode, vehicle VIN, software and ECU.

B. Read Fault Code

This function displays the detailed information of DTC records retrieved from the vehicle's control system.

⚠ Caution: Retrieving and using DTCs for troubleshooting vehicle operation is only one part of an overall diagnostic strategy. Never replace a part based only on the DTC definition. Each DTC has a set of testing procedures, instructions and flow charts that must be followed to confirm the location of the problem. This information can be found in the vehicle's service manual.

On the diagnostic function selection screen, tap **Read Fault Code**, the screen will display the diagnostic result.



On-screen Buttons:

Freeze Frame: When an emission-related fault occurs, certain vehicle conditions are recorded by the on-board computer. This information is referred to as freeze frame data. Freeze frame data includes a snapshot of critical parameter values at the time the DTC is set.

Help: Tap to view the help information.

Code Search: Tap to search for more information about the current DTC online.

Report: Tap to save the current data in text format. All reports are saved in **User Info -> My Report -> Health Reports**. For details on report operations, please refer to Chapter 10.1 **My Report**.

C. Clear Fault Code

This function enables you to erase the codes from the vehicle after reading the retrieved codes from the vehicle and certain repairs have been carried out. Before performing this function, make sure the vehicle's ignition key is in the ON position with the engine off.

Clearing DTCs does not fix the problem(s) that caused the code(s) to be set. If proper repairs to correct the problem that caused the code(s) to be set are not made, the code(s) will appear again and the check engine light will illuminate as soon as the problem that cause the DTC to set manifests itself.

On the diagnostic function selection screen, tap **Clear Fault Code**, a confirmation dialog box will appear.

Tap **YES**, the system will automatically delete the currently existing trouble code.

📝 Note: After clearing, you should retrieve trouble codes once more or turn ignition on and retrieve codes again. If there are still some trouble codes in the system, please troubleshoot the code using a factory diagnosis guide, then clear the code and recheck.

D. Read Data Stream

This option lets you view and capture (record) real-time Live Data. This data including current operating status for parameters and/or sensor information can provide insight on overall vehicle performance. It can also be used to guide vehicle repair.

⚠ Caution: If you must drive the vehicle in order to perform a troubleshooting procedure, ALWAYS have a second person help you. Trying to drive and operate the diagnostic tool at the same time is dangerous, and could cause a serious traffic accident.

📝 Note: The real time (Live Data) vehicle operating information (values/status) that the on-board computer supplies to the tool for each sensor, actuator, switch, etc. is called Parameter Identification Data (PID).

On the diagnostic function selection screen, tap **Read Data Stream**, the following screen will appear.

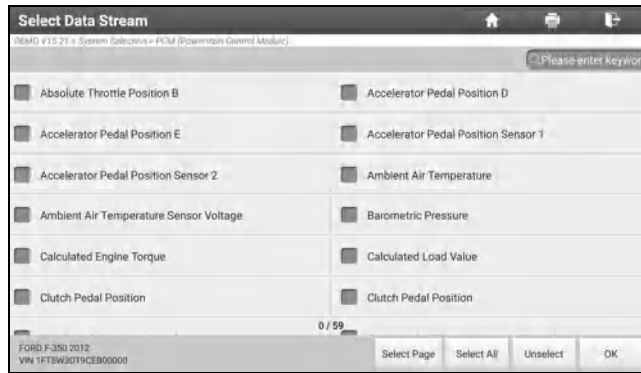

On-screen Buttons:

Select Page: Tap to select all items of the current page.

Select All: Tap to select all items. To select certain data stream item, just check the box before the item name.

Unselect: Tap to deselect all data stream items.

OK: Tap to confirm and jump to the next step.

After selecting the desired items, tap **OK** to enter the data stream reading page.



Notes:

1. If the value of the data stream item is out of the range of the standard (reference) value, the whole line will display in red. If it complies with the reference value, it displays in blue (normal mode).
2. The indicator 1/X shown on the bottom of the screen stands for the current page/total page number. Swipe the screen from the right/left to advance/return to the next/previous page.

There are 3 types of display modes available for data viewing, allowing you to view various types of parameters in the most suitable way.

- ✓ **Value** – This is the default mode which displays the parameters in texts and shows in list format.
- ✓ **Graph** – Displays the parameters in waveform graphs.
- ✓ **Combine** – This option is mostly used in graph merge status for data comparison. In this case, different items are marked in different colors.

On-screen Buttons:

Graph(Single): Tap to view the parameter in waveform graph.



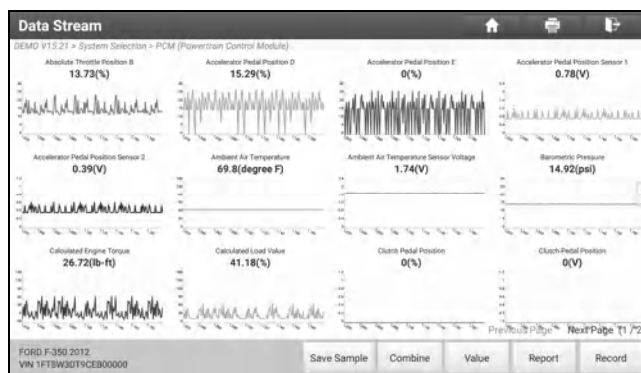

- **Min/Max:** Tap to define the maximum / minimum value. Once the value goes beyond the specified value, the system will alarm.

Graph: Tap to view the parameters in waveform graphs.

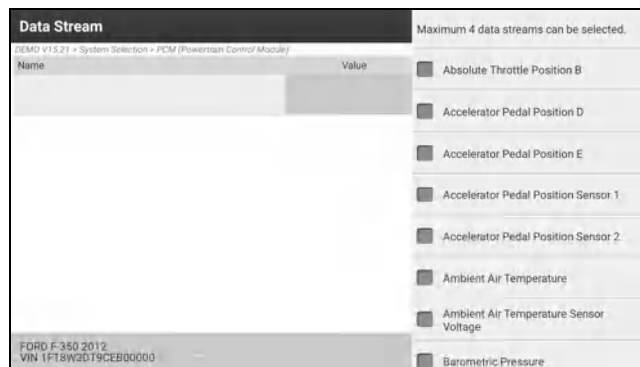

- **Combine:** This option is mostly used in graph merge status for data comparison. In this case, different items are marked in different colors (maximum 4 items can be displayed on the same screen simultaneously). If the graph is more than one page, swipe the screen from the left to jump to the next page.



- **Value:** Switches the current graph display mode to the Value display mode.
- **Customize:** Tap , a pull-down list of the data stream items appears on the screen. Select / deselect the desired items, and then screen will display / remove the waveforms corresponding to these items immediately.

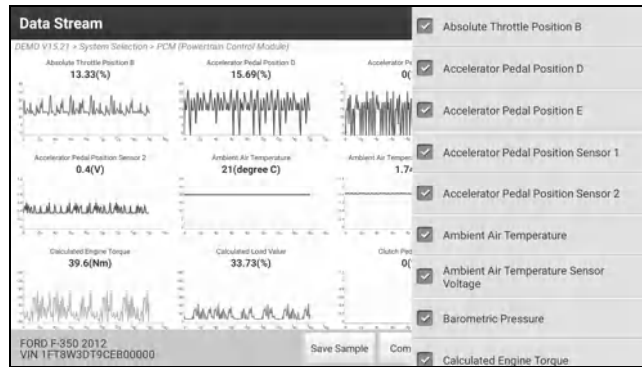

Compare Sample: Tap to select the sample DS file.

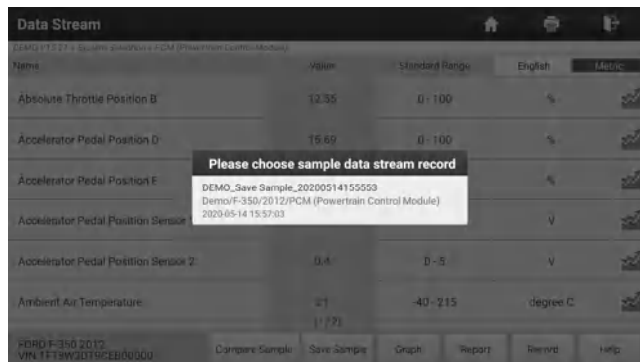

All the values you customized and saved in process of DS sampling will be imported into the **Standard Range** (See below) column for your comparison.

 **Note:** Before executing this function, you have to sample the values of data stream items and save it as a sample Data Stream file.



Report: Tap to save the current data in text format. All reports are saved in **User Info -> My Report -> Health Reports**. For details on report operations, please refer to Chapter 10.1.

Record: Tap to start recording diagnostic data. Recorded live data can serve as valuable information to help you in troubleshooting of vehicle problems.





Tap  to end recording and save it. The saved file follows the naming rule: It begins with vehicle type, and then the product S/N and ends with record starting time (To differentiate between files, please configure the accurate system time).

All diagnostic records can be replayed from **User Info -> My Report -> Recorded Data**.

Save Sample: This item enables you to customize the standard range of live data stream items and save it as DS sample file. Each time you run the data stream items, you can call out the corresponding sample data to overwrite the current standard range.

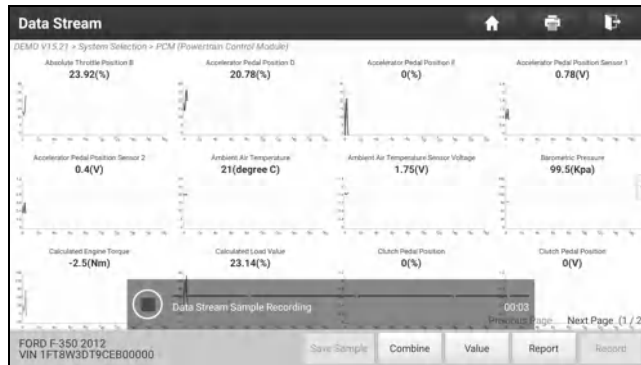
Tap it to start recording the sample data  Note: Only data stream items with measurement units will be recorded), the following screen will appear:



Once the recording process is complete, tap  to stop it and navigate to the data revision screen.



Tap the Min./Max. value to change it. After modifying all desired items, tap **Save** to save it as a sample DS file. All DS files are stored in **User Info -> Data Stream Sample**.

E. Actuation Test

This option is used to access vehicle-specific subsystem and component tests. Available test vary by vehicle manufacturer, year, and model.

During the actuation test, the display tablet outputs commands to the ECU in order to drive the actuators, and then determines the integrity of the system or parts by reading the ECU data, or by monitoring the operation of the actuators, such as switching a injector between two operating states.

On the diagnostic function selection screen, tap **Actuation Test**, the system will display as follows:

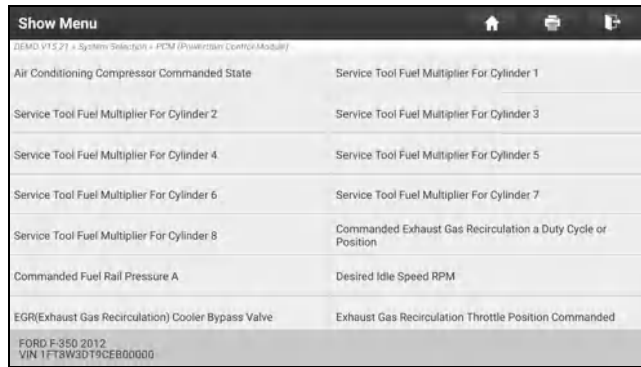

Simply follow the on-screen instructions and make appropriate selections to complete the test.

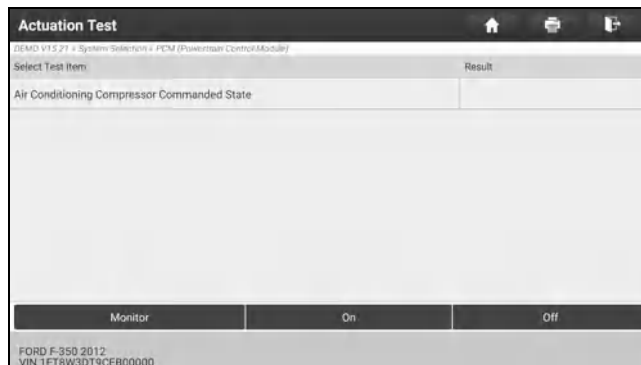

Each time when an operation is successfully executed, “Completed” displays.

F. Special Function

It offers coding, reset, relearn and more service functions, to help vehicles get back to functional status after repair or replacement.

5.2.4 ADAS calibration

This function enables users to perform ADAS calibration operations. The ADAS calibration software is disabled by default. Before using this function, users must activate it using the ADAS Activation Card.

5.3 Remote Diagnose

5.3.1 SmartLink Super Remote Diagnostics

SmartLink is a newly developed powerful service system dedicated to remote vehicle diagnosis and service. In the SmartLink ecology system, if a technician (SmartLink C) does not have time to puzzle through a touch vehicle problem, he can seek a trusted second opinion or additional expertise on various vehicle issues from remote master technicians or repair shops (SmartLink B). SmartLink B enables the shop owner to greatly increase customer’s retention and boost shop revenue by providing the professional technical assistance service.

It mainly consists of the following parts:

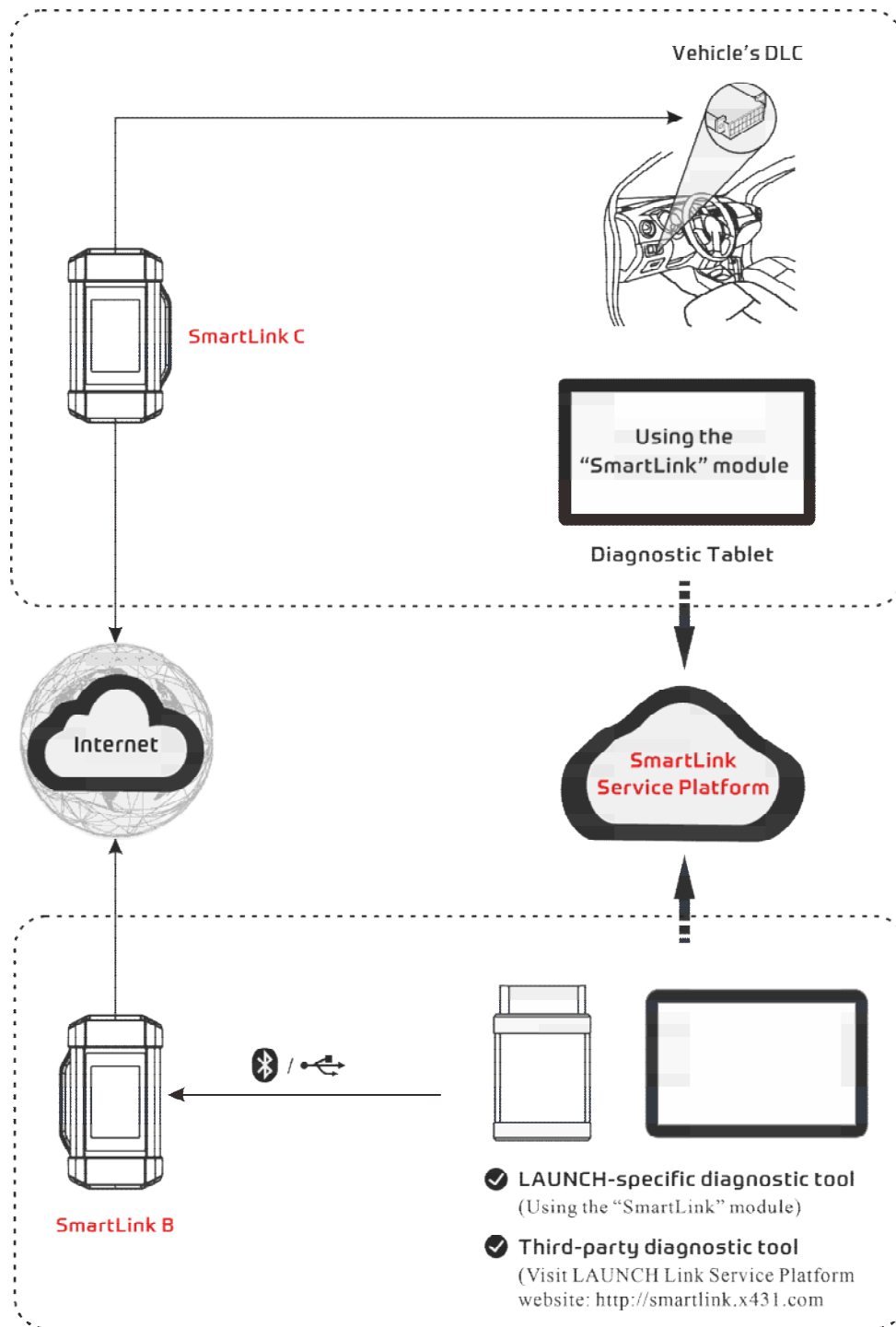

- **SmartLink Service Platform** – It can be accessed from the **SmartLink** module of the diagnostic tablet. There are two modules available on the link service platform: **Common user** (for SmartLink C) and **Service provider** (for SmartLink B).
- **SmartLink C (Customer) - SmartLink Service Subscriber.** In the SmartLink system, the SmartLink C needs to perform the following operations.
 - 1). Launch Service Link Platform: Binds SmartLink C dongles and submits remote repair orders.
 - 2). SmartLink C Dongle: Connects to the vehicle’s DLC port for collecting the vehicle data and sends it to the remote SmartLink B.

It supports remote diagnostic services for vehicles that meet CAN / CAN FD / J2534 vehicle diagnostic standards.
- **SmartLink B (Business) - SmartLink Service Provider.** In the SmartLink system, the SmartLink B needs to

perform the following operations.

- 1). Launch Service Link Platform: Binds SmartLink B dongles and accepts orders from SmartLink C.
 - If the SmartLink B dongle works with the LAUNCH-specific diagnostic tool equipped with SmartLink module, tap **SmartLink** to add the SmartLink B device and accepts orders on the diagnostic tool.
 - If the SmartLink B dongle works with the third-party diagnostic tool, open the browser and visit SmartLink Service Platform website <http://smartlink.x431.com> (web client) to add the SmartLink B device and accepts orders in the browser.
- 2). SmartLink B Dongle: After accepting the orders, it can work with the compatible diagnostic tool to perform diagnosis of the vehicle connected to the SmartLink C dongle.

For more detailed operations, refer to the User Manual integrated in the SmartLink Platform.

5.3.2 X431 Remote Diagnostics

This option aims to help repair shops or technicians launch instant messaging and remote diagnosis, making the repair job getting fixed faster.

Tap **Remote Diagnose -> X431 Remote Diagnosis** to enter the following screen.

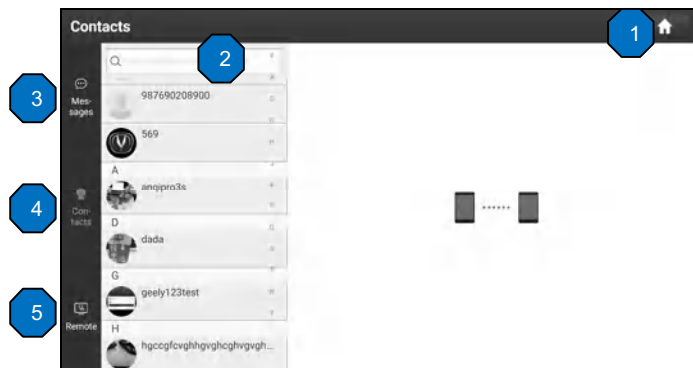

1	Home button	Tap it to navigate to the home screen.
2	Search bar	Directly input the registered username of the tool to start searching, and then tap the desired one to add it into your friend list.
3	Messages tab	Once an incoming message reaches, a red dot will appear on the upper right corner of the tab.
4	Contacts tab	Tap to enter the friend list.
5	Remote	Tap to slide the switch to ON, the tool will become accessible on the web client. In this case, inform the technician of your product S/N, and he/she will control your device remotely.

1. Adding friends

Tap **Contact** to enter the contact page. By default it appears blank.

In the search bar, input the partner's username and tap **Search** button next to the search bar to starts searching from Launch's business database.

The partner must be the users who have registered their Launch-specific diagnostic tools. They may be the following:

- Workshop
- Technician
- golo users

Once the result matches the keyword, the following screen will appear:



Tap **Remote Diagnose** to launch remote diagnostics directly or follow the steps below to add the partner into the Contacts list.

Tap the desired name from the list, the following screen will appear:

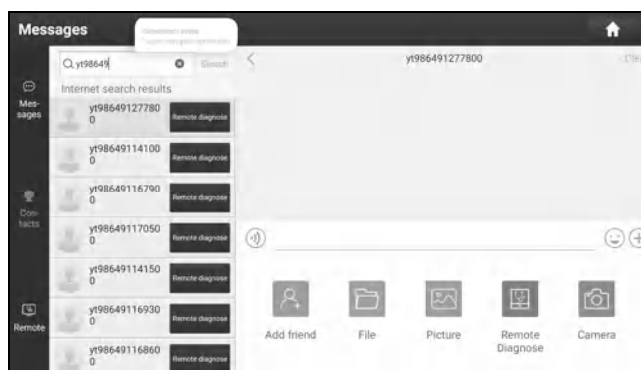

Tap **Add friend**, a dialog box pops up:



Tap **CONFIRM** to send your request.

Once the partner receives the request, a beep will sound. Tap the **Message** tab:

- Once the partner agreed your request, he/she will automatically be listed in the **Contacts** tab.
- If a technician sent you a friend request, tap **Agree** and his/her name will appear in the friend (**Contacts**) list. Or tap **Ignore** to ignore this request.



2. Start instant messaging

 Note: The I/M (Instant Messaging) function is open to all users who had Launch’s diagnostic tool equipped with this module. After adding your friends, tap the desired one’s photo to enter a screen similar to the following figure:

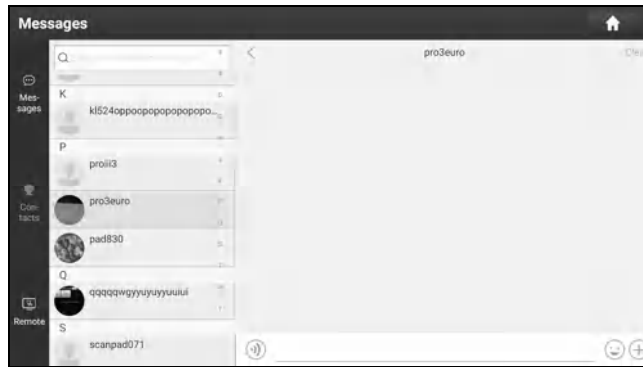

Tap the input field and use the on-screen keyboard to enter the text message, and then tap **Send** to send it.

Tap to send the voice message.

Tap to send the emoji.

Tap to call out more function options.

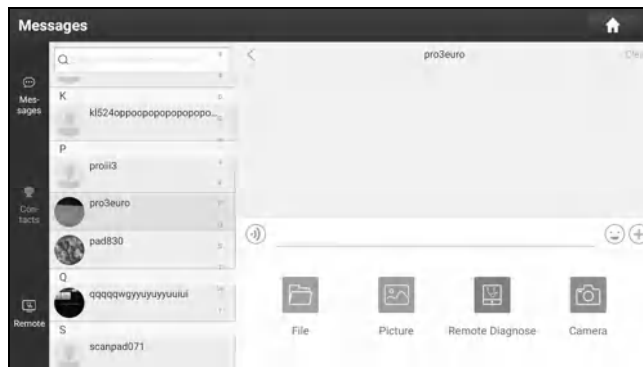

File: Choose diagnostic reports or local files to send.

Picture: Choose screenshots or pictures to send.

Remote Diagnose: To start a remote diagnostic session. For details, refer to Chapter 5.3.4.

Camera: Open camera to take pictures.

Tap **Clear** to delete all the partner’s dialog logs.

Tap **Close** to close the current dialog.

3. Launch remote diagnosis (Device-To-Device)

The tool is allowed to initiate remote diagnosis with other diagnostic tools (including but not limited to the X-431 PAD V of Launch family, which are equipped with this module.

Notes: Before performing this operation, please make sure the following no matter which side sends the remote request:

- Turn on the vehicle power supply.
- Throttle should be in a closed position.
- The tool should be properly connected to the vehicle’s DLC and a successful communication is required.

On the function option selection screen, tap **Remote Diagnostic**, the following screen will appear:

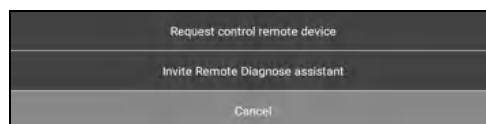

These options are defined as follows:

Actions	Results
Request control remote device	Request to control the partner’s device remotely to help him diagnose the vehicle. Notes:

	<ul style="list-style-type: none"> • Remote diagnosis has the same diagnostic steps as manual diagnosis. • In process of remote diagnosis, tap the 🗣️ button to send a voice message. • Once vehicle diagnosis is complete, a report will be created. Input your comments on this report, and then tap Send Report to send it to the partner. <div style="text-align: center;"> <pre> graph TD A[Tap "Request control remote device"] --> B[Wait for partner's confirmation] B --> C[Start connecting after request confirmed] C --> D[Start Diagnosis] D --> E[Generate diagnostic report] </pre> </div>
<p>Invite remote diagnostic assistant</p>	<p>If you need support, just use this option to invite a technician to perform a remote control on your tool.</p> <p> Notes:</p> <ul style="list-style-type: none"> • Remote diagnosis has the same diagnostic steps as manual diagnosis. • In process of remote diagnosis, tap the 🗣️ button to send voice message. • Once you received the report from the partner, tap View Report to view its details. All diagnostic reports are saved in User Info -> My Reports -> Remote Reports. <div style="text-align: center;"> </div>

	<pre>graph TD; A[Tap "Invite remote diagnostic assistant"] --> B[Choose the desired diagnostic software]; B --> C[Wait for partner's confirmation]; C --> D[Start connecting after request confirmed]; D --> E[Start Diagnosis]; E --> F[Generate diagnostic report];</pre>
Cancel	To cancel this operation.

4. Launch remote diagnosis (Device-To-PC)

Except that the remote diagnosis can be done between different Launch’s diagnostic tools that come loaded with the module, user also can ask for remote control from PC client technician.

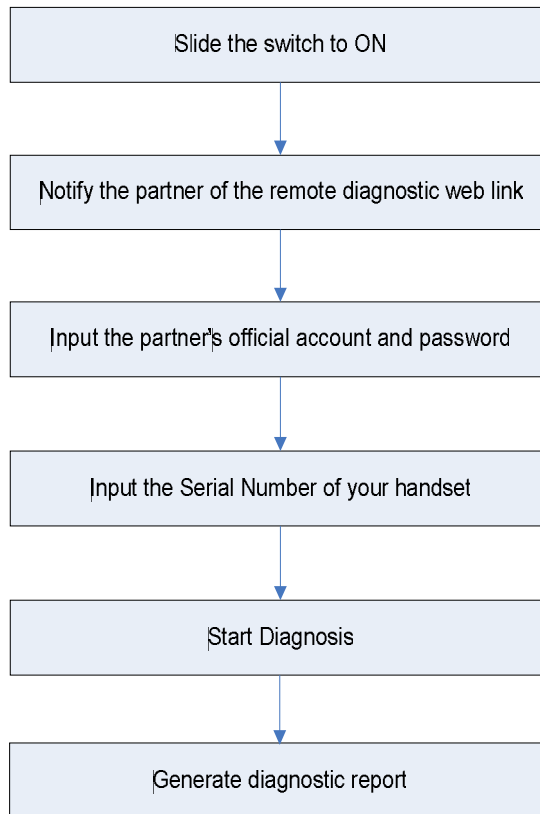

Tap the **Remote** tab, the following screen will appear:

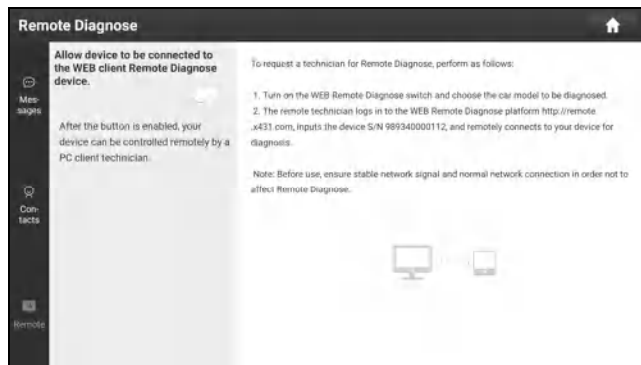

1. Slide the switch **Allow device to be connected to the WEB client remote diagnostic device** to ON so that the partner can find and connect to this device while using the PC.
2. Notify the partner of the PC client website <http://remote.x431.com>. When the partner accesses the link, the following screen will appear:

 Note: Before processing remote diagnosis, please make sure the tool is properly connected to the vehicle.

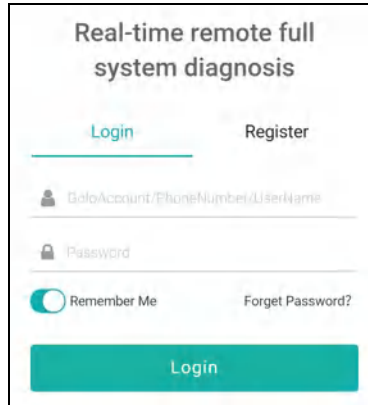

3. Tell the partner to input his own official technician account and password, and then tap **Login** to navigate to the following figure.

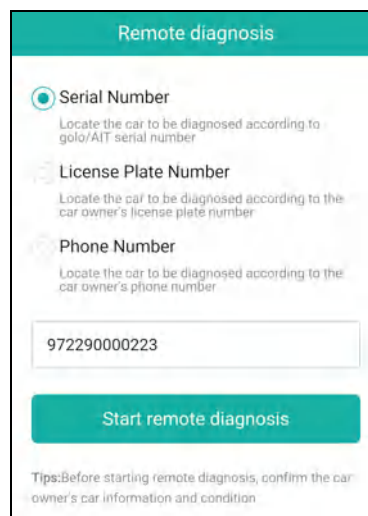

4. Tell the partner to check the box **Serial number** and enter the Serial Number provided by you, and then tap **Start remote diagnosis** to control your device remotely.

In process of remote diagnosis, please note the following things:

- 1) You are not suggested to execute any actions.
- 2) The partner is not allowed to save any diagnostic reports or records on your tool.

The operations in remote diagnosis are same as those in local diagnose. Once the session is complete, a remote diagnostic report will be automatically generated.

5.4 Diagnostic History

When a vehicle diagnosis is performed, the tablet records the detailed diagnostic information. The History function allows access to previously tested vehicle records. Testing can be resumed from the previous operation without starting from scratch.

Tap **Diagnostic History** on the home screen, all diagnostic records will be listed on the screen in date sequence.

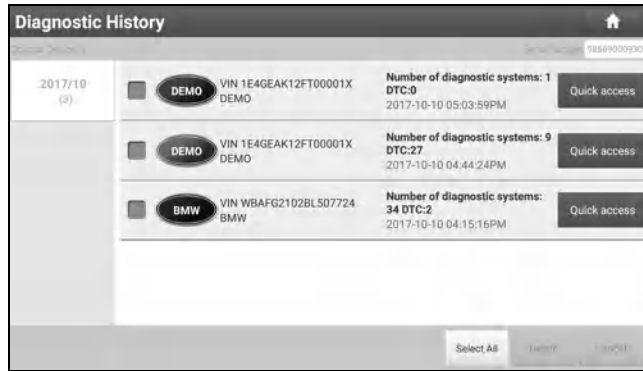

- Tap certain vehicle model to view the details of the last diagnostic report.
- To delete certain diagnostic history, select it and then tap **Delete**. To delete all historical records, tap **Select All** and then tap **Delete**.
- Tap **Quick access** to directly navigate to the function selection page of last diagnostic operation. Choose the desired option to proceed.

5.5 Feedback

This item allows you to feedback your diagnostic problems to us for analysis and troubleshooting.

Tap **Feedback**, a pop-up message will appear.

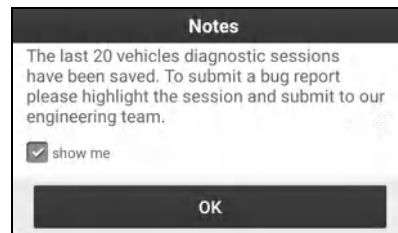

Tap **OK** to choose the vehicle diagnostic record page.

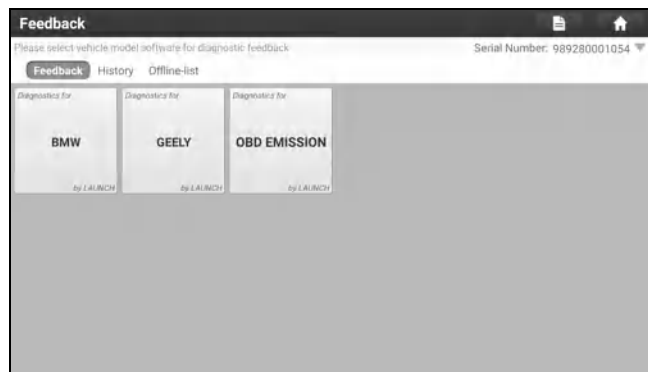

A. Feedback

Tap certain tested vehicle model to enter the feedback screen.

Feedback

Diagnostics for
BMW
by LAUNCH
Current software version: V50.52
Latest software version: V50.52
Make:-
Model:-
Year:-
VIN:-

1. Choose feedback log **Choose file**

2. Choose feedback problem type

Consult or error System or function access failed Special functions Others

Input your phone number or email (at least one item is mandatory). We will contact you as soon as possible

Input your phone/email

Add image (optional, provide problem screenshot)

Add data stream files (optional) **Add files**

- 1) Tap **Choose File** to open the target folder and choose the desired diagnostic logs.
- 2) Choose the failure type and fill in the detailed failure description in the blank text box and telephone or email address. After inputting, tap **Submit Result** to send it to us.

B. History

Tap it to view all diagnostic feedback records. Different process states are marked with different colors.

C. Offline list

Tap it to display all diagnostic feedback logs which have not been submitted successfully due to network failure. Once the tablet gets a stable network signal, it will be uploaded to the server automatically.

6 Service Function

This module provides an easy dial to quickly access the most commonly performed service functions.

It offers coding, reset, relearn and more service functions, to help vehicles get back to functional status after repair or replacement.

6.1 Oil Reset Service

This function enables you to reset the oil service for the engine oil life system, which calculates an optimal oil life change interval depending on the vehicle driving conditions and weather events.

It needs to be performed in the following cases:

1. If the service lamp is on, run car diagnostics first for troubleshooting. After that, reset the driving mileage or driving time, so as to turn off the service lamp and enable a new driving cycle.
2. If the service lamp is not on, but you have changed the engine oil or electric appliances that monitor oil life, you need to reset the service lamp.

6.2 Electronic Parking Brake Reset

This function enables you to reset the brake pad after replacing the brake pad.

It needs to be performed in the following cases:

- The brake pad and brake pad wear sensor are replaced.
- The brake pad indicator lamp is on.
- The brake pad sensor circuit is short, which is recovered.
- The servo motor is replaced.

6.3 Steering Angle Calibration

This function can reset the steering angle to zero to keep the car running straight.

It needs to be performed generally after replacing the steering angle position sensor, or after replacing the mechanical parts of the steering system (such as steering gear, steering column, tie rod ball head, steering knuckle), or after completing the four-wheel alignment, body repair, etc.

To reset the steering angle, first find the relative zero point position for the car to drive in straight line. Taking this position as reference, the ECU can calculate the accurate angle for left and right steering.

6.4 ABS Bleeding

This function allows you to perform tests to check the operating conditions of Anti-lock Braking System (ABS).

It needs to be performed in the following cases:

1. When the ABS contains air.
2. When the ABS computer, ABS pump, brake master cylinder, brake cylinder, brake line, or brake fluid is replaced.

The bleeding procedure is as follows: 3 people are required to cooperation with the operation. One person is responsible for depressing the brake, another is in charge of adding brake fluid and the other takes charge of loosening or tightening the screws for bleeding.

6.5 Tire Pressure Monitor System Reset

This function can reset the tire pressure and turn off the tire pressure MIL.

It needs to be performed in the following cases:

1. After the tire pressure MIL turns on and maintenance is performed, the tire pressure resetting function must be

performed to reset tire pressure and turn off the tire pressure MIL.

2. Tire pressure is too low, tire leaks, tire pressure monitoring device is replaced or installed, tire is replaced, tire pressure sensor is damaged, and tire is replaced for the car with tire pressure monitoring function.

6.6 Gear Learning

This function enables you to perform tooth learning for the car, to turn off the related Malfunction Indicator Light (MIL).

It needs to be performed in the following cases:

1. After the engine ECU, crankshaft position sensor, or crankshaft flywheel is replaced.
2. The DTC 'tooth not learned' is present.

6.7 Anti-theft Matching

This function enables you to perform the anti-theft key matching function, so that the immobilizer control system on the car identifies and authorizes remote control keys to normally use the car.

It needs to be performed in the following cases:

- When the ignition key, ignition switch, instrument cluster, engine control unit (ECU), body control module (BCM), or remote control battery is replaced.

6.8 Injector Coding

Write injector actual code or rewrite code in the ECU to the injector code of the corresponding cylinder so as to more accurately control or correct cylinder injection quantity.

After the ECU or injector is replaced, injector code of each cylinder must be confirmed or re-coded so that the cylinder can better identify injectors to accurately control fuel injection.

6.9 Battery Matching

This function can reset the monitoring unit of the car battery, by clearing the original breakdown information about the lack of battery power to rematch the battery.

It needs to be performed in the following cases:

1. The main battery is replaced. The replacement of the main battery needs to utilize battery matching to clear the former information about the lack of power, thus avoiding false information detected by the relevant control module which may cause the failure of some electronic auxiliary functions. For example, the vehicle automatically stops; the sunroof can't work by one key; electric window can't open and close automatically.
2. The battery monitoring sensor is replaced. The battery monitoring sensor uses the battery matching function to re-match the control module with the monitoring sensor, so as to detect the use of the battery power more accurately, and avoid receiving wrong information from instrument prompts which will cause false alarms.

6.10 Diesel Particulate Filter (DPF) Regeneration

This function can help remove PM (Particulate Matters) from the DPF filter by using combustion oxidation methods (such as high temperature heating combustion, fuel additive or catalyst reduce PM ignition combustion) to keep the performance of the filter stable.

It needs to be performed in the following cases:

- The exhaust back pressure sensor is replaced.
- The PM trap is removed or replaced.
- The fuel additive nozzle is removed or replaced.
- The catalytic oxidizer is removed or replaced.
- The DPF regeneration MIL is on and maintenance is performed.

- The DPF regeneration control module is replaced.

6.11 Throttle Matching

This function can utilize the diagnostic scanner to initialize the throttle actuator so that the learning value of the ECU returns to the initial state. By doing so, the movement of the throttle (or idle motor) can be more accurately controlled, thus adjusting the intake volume.

It needs to be performed in the following cases:

- After replacing the electronic control unit, the relevant characteristics of the throttle operation have not been stored in the electronic control unit.
- After the electronic control unit is powered off, the memory of the electronic control unit's memory is lost.
- After replacing the throttle assembly, you need to match the throttle.
- After replacing or disassembling the intake port, the controlling of the idle speed by the coordination between the electronic control unit and the throttle body is affected.
- The intake volume, and the idle control behavior has changed while staying at the same throttle opening position, although the idle throttle potentiometer behavior hasn't changed.

6.12 Gearbox Matching

This function can complete the self-learning of the gearbox and improve the shift quality.

It needs to be performed in the following cases:

When the gearbox is disassembled or repaired.

6.13 AFS (Adaptive Front-lighting System) Reset

This function enables you to initialize the adaptive headlamp system.

6.14 Sunroof Initialization

This function can set the sunroof lock off, close in rain, memory function of sliding / tilting sunroof, outside temperature threshold, etc.

6.15 Suspension Calibration

This function can adjust the vehicle body height sensor for level calibration.

It needs to be performed in the following cases:

1. When replacing the body height sensor, or control module in the air suspension system.
2. When the vehicle height is incorrect.

6.16 EGR Adaption

This function is used to learn the EGR (Exhaust Gas Recirculation) valve after it is cleaned or replaced.

6.17 Windows Calibration

This function is used to perform door window matching to recover the ECU initial memory, and recover the automatic ascending and descending function of power window.

6.18 Seats Calibration

This function is applied to match the seats with memory function that are replaced and repaired.

6.19 Tyre Reset

This function is used to set the size parameters of the modified or replaced tire.

6.20 Language Change

This function is used to change the system language of the vehicle central control panel.

6.21 A/F Reset

This function is applied to set or learn Air/Fuel ratio parameters.

6.22 Coolant Bleed

Use this function to activate the electronic water pump before venting the cooling system.

6.23 Transport Mode

To lower vehicle power consumption, user may perform the following operations: limit vehicle speed, not wake up the network for door open and disable remote key etc. In this case, deactivating transport mode is needed to recover vehicle being normal.

6.24 AdBlue Reset (Diesel Engine Exhaust Gas Filter)

After the diesel exhaust treatment fluid (car urea) is replaced or filled up, urea reset operation is required.

6.25 NOx Sensor Reset

NOx sensor is a sensor used to detect the content of nitrogen oxides (NOx) in engine exhaust. If the NOx fault is re-initialized and the NOx catalytic converter is replaced, it is necessary to reset the catalytic converter learned value stored in the engine ECU.

6.26 Stop/Start Reset

This function is used to open or close the automatic start-stop function via setting the hidden function in ECU (provided that the vehicle has a hidden function and supported by hardware).

7 Software Update

This module enables you to update the diagnostic software & App and frequently used software.

7.1 Update Diagnostic Software & APP

Go to **Software Update** on the Job Menu and tap the **Downloaded** tab.

The **Available** tab displays a list of software that can be updated. Under it, all software is categorized into three kinds:

- **Common software:** mainly includes some common apps that are associated with the diagnostic app. The software of this kind always stays at the top of the list, which can be deselected manually (excluding the system app, such as firmware and ECU aid).
- **Frequently used vehicle software:** refers to the diagnostic software that is frequently used, including the vehicle diagnostic software and Reset software. It is generally displayed following the **Common software** list.
- **Other vehicle software:** refers to the diagnostic software that is rarely used or never used. It is generally displayed following the **Frequently used software** list.

- 1). If the user does not download any diagnostic software during the sign-up process, all diagnostic software is selected by default. Tap **Update** to start downloading.
- 2). If the user downloaded all/some vehicle software during the sign-up process and had it serviced for a long period of time, only the frequently used software is selected. Tap **Update** to start downloading. Other vehicle software that is rarely used will also be listed under the **Available** tab, but it is not selected at default.

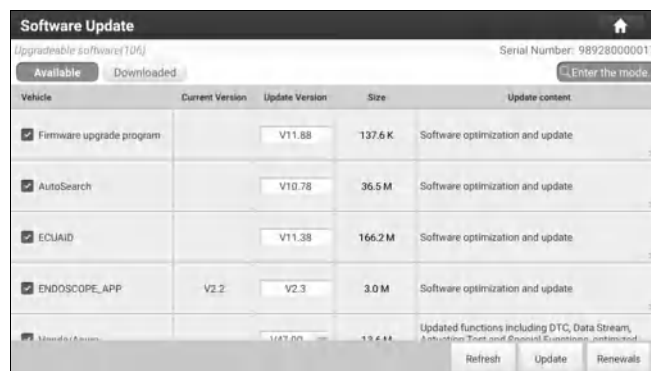

To download certain software that is not frequently used, check the box before the vehicle model. Tap **Update** to start downloading.

Once download is finished, the software packages will be installed automatically.

7.2 Update Frequently Used software

If the user only intends to update the frequently used software, go to Software Update and tap the **Downloaded** tab.



Tap **Update** to start downloading. Once download is finished, the software packages will be installed automatically.

7.3 Renew Subscription

If the software subscription is due or expires, the system will prompt you to renew your subscription.

Tap **Renewal** on the bottom of the screen to enter the **Mall** to renew the subscription.

8 TPMS

This module allows you to configure the tablet as TPMS activation & diagnostic tool, which provides the ability to trigger TPMS sensor, program TPMS sensor, perform the relearning procedure. It needs to work with the compatible TSGUN device (sold separately).

For more details, please refer to the User Manual included with the module.

9 ADAS

This module enables you to effectively and accurately calibrate a wide range of camera-based & radar-based driver assistance systems, e.g. the front camera for the lane departure warning system, the radar sensor for the ACC (Adaptive Cruise Control) or the camera for adaptive headlights. It needs to work with the specific ADAS calibration tool (sold separately).

For more details, please refer to the User Manual included with the module.

10 User Info

This function allows users to manage personal information and VCI.

10.1 My Report

This option is used to view, delete or share the saved reports.

Tap **My Report**, there are total 3 options available.

1). If the DTC result is saved on Read Trouble Code page, the files will be listed under **Health Reports** tab.

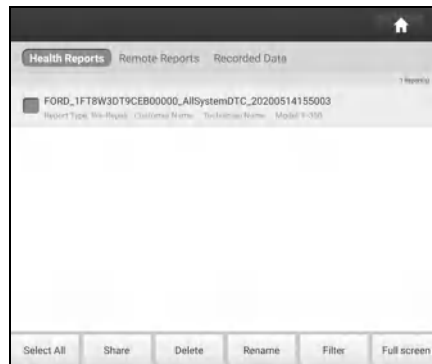

All diagnostic reports are sorted by Date and Make. Tap the desired type to re-arrange and filter it.

- To select certain report, check the box before the report. To select all reports, tap **Select All**. To deselect all, tap **Unselect**.
- To share the report with others, select the desired one and then tap **Share**.
- Select the desired report and then tap **Delete** to delete it.
- To change the filename of report, tap **Rename**.
- To quickly locate the desired report, tap **Filter**.
- To exit the full screen, tap **Exit full screen**.

2). **Remote Reports** lists all diagnostic reports generated in process of remote diagnosis.

3). If user records the running parameters while reading data stream, it will be saved as .x431 file and appear under **Recorded Data** tab.

Tap the desired one to enter. Select the desired data stream items and tap **OK** to jump to the playback page:



On-screen Buttons:

Graph – displays the parameters in waveform graphs.

Value – this is the default mode which displays the parameters in texts and shows in list format.

Combine – this option is mostly used in graph merge status for data comparison. In this case, different items are marked in different colors.

Frame Playback – plays back the recorded data stream items frame by frame. Once it is in frame playback mode, this button changes into **Auto Playback**.

10.2 VCI

This option allows you to manage all your activated VCIs.

If several VCIs are activated on this tool, a list of VCIs will be displayed on the screen. Once you choose the VCI that belongs to other account, you have to log out, and then input the right account to continue.

10.3 Activate VCI

This item lets you activate a new VCI.

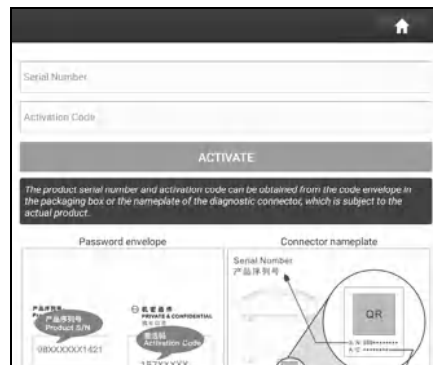

Input the Serial Number and Activation Code, and then tap **Activate** to activate it.

10.4 Fix Connector Firmware/System

Use this item to upgrade and fix VCI firmware/system. During fixing, please do not cut power or switch to other interfaces.

10.5 Sample

This feature allows you to manage the recorded data stream sample files.

10.6 Vehicle Voltage

This item performs a check of the vehicle’s battery to ensure the system is operating within acceptable limits.

10.7 My Order

This item allows you to check the status of all your orders.

10.8 Subscription Renewal Card

This item is used to check the status of the subscription renewal card.

Input the 12-digit subscription renewal card number. Tap **Search** to get the search result.

10.9 Profile

Use this item to view and configure personal information.

- The profile description includes a ‘placeholder’ for a user photograph. Tap the user image to change it.
- Tap > next to **Upgrade Period** to check the due date of all diagnostic software.

10.10 Change Password

This item allows you to modify your login password.

10.11 Settings

It enables you to make some application settings and view software version information etc.

10.11.1 Units of measurement

It is designed to configure the measurement unit. Metric System and English System are available.

10.11.2 Shop information

This option lets you define your print information. It mainly includes Workshop, Address, Telephone, Fax and License Plate.

After inputting, tap **Save**.

Once you saved the print information, it will be entered automatically in the "Add Information" box every time you save the diagnostic report.

10.11.3 Printer set

This option is designed to establish a wireless connection between the tablet and the Wi-Fi printer (sold separately) while performing printing operations.

The App is compatible with the **LAUNCH Wi-Fi Printer** (sold separately) and **System** (external printer).

For LAUNCH Wi-Fi printer, refer to the User Manual included with the Wi-Fi printer to configure the printer settings.

For other Wi-Fi printers,

Before printing, make sure the following conditions are met:

- The Wi-Fi printer is powered on and working normally.
- The print service plug-in associated with the printer is already installed on the tablet (Go to Google Play or use the Browser to download and install it).

Follow the steps below to proceed:

1. Set the default printer as **System**.
2. Go to **Other Modules** -> **Built-in apps** -> **Tablet Settings** -> **WLAN**, set the WLAN switch to Off.
3. On the report details page, tap .



4. Touch ▼ next to **Select a printer** on the upper left corner of the screen.

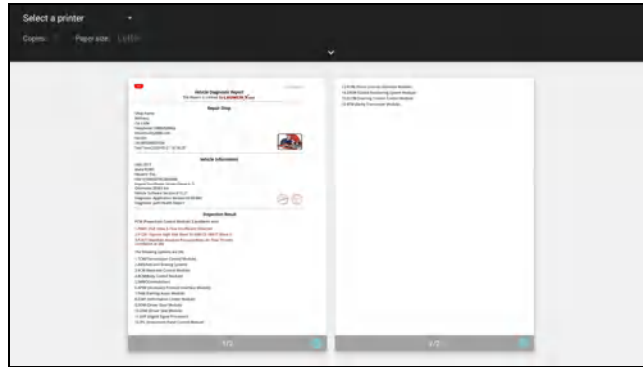

5. Select **All Printers** -> **Add printer** and enable the installed printer service, the system starts searching for all available Wi-Fi printers of the brand.

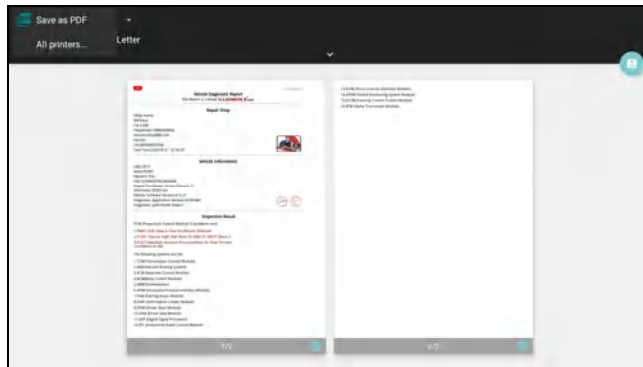

6. Select the desired Wi-Fi printer from the list. If the chosen Wi-Fi printer hotspot is open, the tablet can connect it directly. If it is encrypted, a password may be required. Refer to the Wi-Fi printer user manual to get the default password.

7. Now the printer is ready for printing.

8. Alternatively, you can also choose **Save as PDF** to save the current diagnostic report as a PDF file for later printing.

10.11.4 Home screen display order

This option is used to set the display order of all function modules on the home screen.

10.11.5 Clear cache

This item is used to clear the App cache.

Tap **Clear Cache**, a pop-up window will appear on the screen. Tap **OK** to clear cache and the system will restart the App.

10.11.6 About

The software version information and disclaimer are included.

10.11.7 Diagnostic software auto update

This option is used to set whether automatic update function is ON.

10.11.8 Device account management

This option is used to manage the sub-accounts. The added sub-account allows the VCI connector to be used by different users to log in the tool, which is convenient for multiple VCIs to perform diagnostic service at the same time.

The newly added sub-account has a one-year validity period. After the expiration, the VCI bound to the sub-account cannot be used and the sub-account will no longer enjoy the rights and interests of the main account. The main account can modify the validity period of the sub-account.

There are two types of sub-accounts: one is an existing account and the other is a newly created account. The main account has the functions of adding and removing sub-accounts, the sub-account can also be unbound from the main

account.

Tap **Device account management**, the following screen will appear:

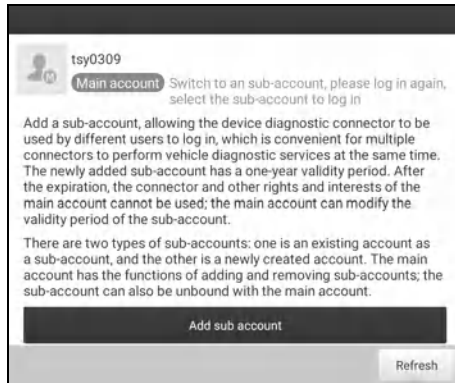

Tap **Add sub account**, the following popup will appear:

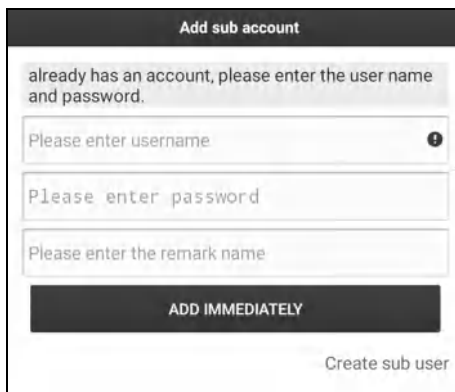

- If you already have an account, please enter the user name and password. After inputting, tap **Add Immediately** to add it as a sub-account.
- If you have not registered any account, tap **Create sub user**. Enter the user name and password, and then tap **Add Immediately** to add it as a sub-account.

After adding the sub-account, the following screen will appear:

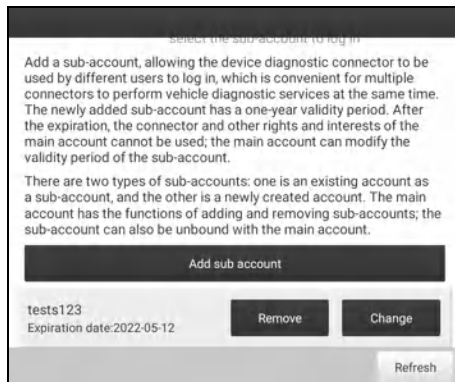

To unbind it from the main account, tap **Remove**. To revise the validity period, tap **Change**.

10.11.9 Login/Log out

To logout the current user ID, tap **Log Out**.

To login the system again, tap **Login**.

10.12 Diagnostic Software Clear

This item allows you to hide/clear the diagnostic software that is not frequently used.

*Note: Removing software may completely delete the software from the tablet. If some software is not used and the tablet runs out of space, you can use this feature to remove it. To re-download it, go to **Software Update** -> **Available**.

11 Other Modules

11.1 Toolbox

This function includes the following add-on modules: Oscilloscope, Ignition, Sensor, Multimeter, Battery Tester and Videoscope.

Each module consists of two parts: hardware and app. These modules cannot work properly on the tablet, which need to work with the specific compatible hardware (sold separately). For detailed operations, refer to the User Manual of each module.

11.2 Tablet Setting

This module provides a quick dial to the Android's system settings. Alternatively, it also can be accessed by tapping the **Settings** on the Android home screen.

11.3 Files

ES File Explorer is a file and application manager. You can access and create folders on the tablet without needing to connect it to a computer.

The app also features an application manager, task killer and download manager. Another excellent feature is support for cloud storage accounts. This means you can download files directly to the folders you want without using a separate app.

The app has built-in ZIP and RAR sources, so you can access compressed files without unpacking them on your computer first.

For more information, please refer to the associated ES file explorer documents.

11.4 Wireless Upgrade

An Over-the-Air (OTA) update is the wireless delivery of new operating system, software or data to tablets and mobile phones. Wireless carriers have traditionally used over-the-air updates to deploy firmware and configure phones or tablets for use on their network. The initialization of a newly purchased tablet required an over-the-air update.

*Note: While performing OTA update, please make sure the tablet battery has at least 70% and DO NOT run any other programs during the update.

1. On the home screen, tap **Other modules -> Wireless Upgrade**.

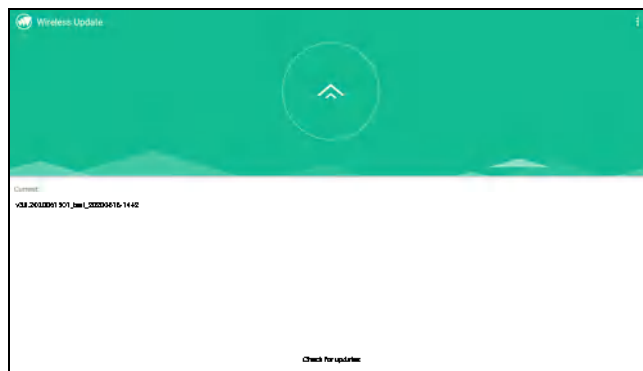

2. Tap **Check for updates**. Once a newer version is found, follow the on-screen instructions to download and install the update file.
3. Be patient to wait until the update is done.

11.5 TeamViewer QS

This function enables you to receive remote support from technician fellows, colleagues or friends by allowing them to control your tablet on their computer view TeamViewer software.

On the home screen, tap **Other modules** -> **Built-in apps** -> **TeamViewer**. The following screen will appear:

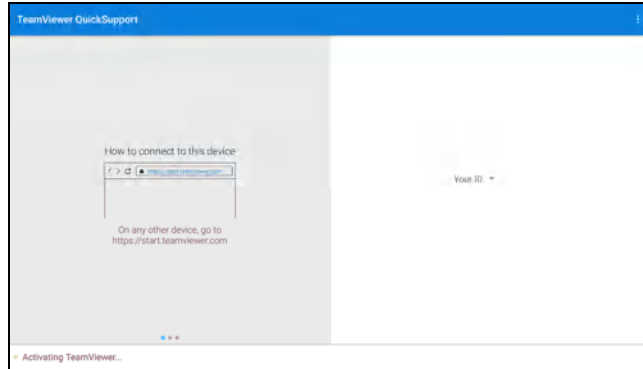

*Note: In order to provide support and take control of your tablet remotely, your partner needs to install and run the TeamViewer full version program in his computer, and have your TeamViewer ID. Visit <http://www.teamviewer.com> for details.

11.6 Recording Master

This module is a free and convenient application that allows you to take tablet screen video capture of high quality, with or without sound.

11.7 Browser

This browser is a free cross-platform web browser. It has gained popularity worldwide, featuring tools such as file downloads, password settings, and bookmarks. Users can load several web pages or use a search engine to find any topic on the internet.

11.8 Camera

This application allows you to take pictures or record videos with the device camera.

11.9 Gallery

This function allows you to take new pictures and manage the picture library (including screenshots).

11.10 Video Player

This video player is a media player said to be the best ever created since it supports all types of video formats.

It offers excellent features and video quality. It has great gesture controls, making video playback experience effortless and enjoyable. For instance, you can pinch to zoom, scroll for brightness and volume on respective sides, move out the video on the home screen, and can do much more.

11.11 E-Mail

It is an easy-to-use email app that saves you time and keeps your messages safe. Get your emails instantly via push notifications, read and respond online & offline, and find any email quickly.

11.12 Calculator

It is a simple-to-use and responsive app. All calculations are made on-the-fly as you input new data.

12 J2534 Reprogramming Using SmartLink C

Flash programming has become a common and profitable procedure in the repair and service of today's vehicles. As part of the 21st Century Tune-up, reprogramming is often the only solution for problems ranging from driveability and loss of power to poor fuel economy and emissions related issues. SmartLink C makes it easy. The SmartLink C is a communication interface designed to support J2534 specifications for ECU reprogramming.

Except that the SmartLink C can act as a VCI device and a SmartLink dongle, it also can be used as a J2534 PassThru device, working together with the PC installed with the OEM diagnostic software to perform the J2534 reprogramming. In this case, the PC needs to install with the LAUNCH's J2534 tool, which can be downloaded from the official website at www.cnlaunch.com.

12.1 As a Local J2534 PassThru Device

Except that the SmartLink C acts as a VCI device and a SmartLink dongle, it also can be used as a J2534 PassThru device, working together with the PC installed with the OEM diagnostic software to perform the J2534 reprogramming. In this case, the PC needs to install with the LAUNCH's J2534 tool, which can be downloaded from www.cnlaunch.com.

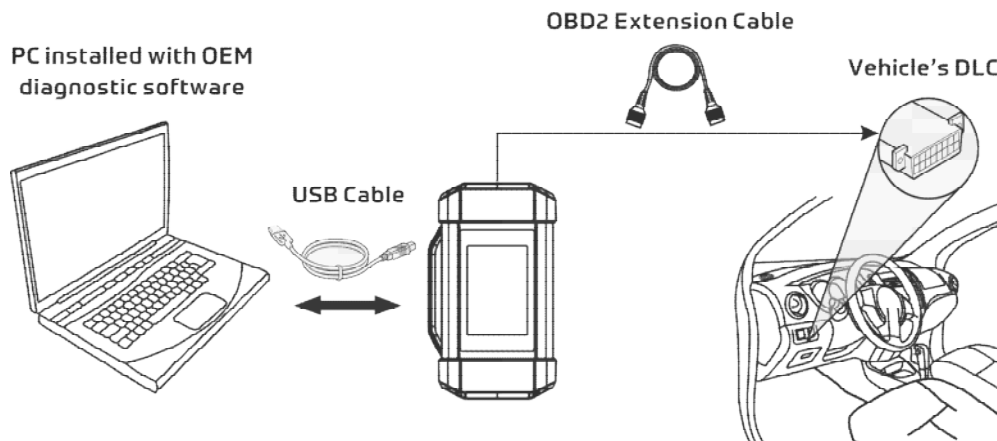

12.2 As a Remote J2534 PassThru Device

Besides local ECU reprogramming, remote ECU reprogramming function is also supported using SmartLink C.

*Note: Before diagnosing, please make sure the following conditions are met:

- The SmartLink C device is connected to the Internet and has a strong network signal.
- The OEM diagnostic software has been installed on the PC.
- The LAUNCH's J2534 tool also needs to be installed on the PC. This tool and its associated operation instruction documentation can be downloaded from www.cnlaunch.com.

Ensure that the remote reprogramming operation is performed after the SmartLink C is connected to the vehicle's DLC port and the Internet, and has been switched to the super remote diagnosis mode. For specific operations, please refer to other associated documentation.

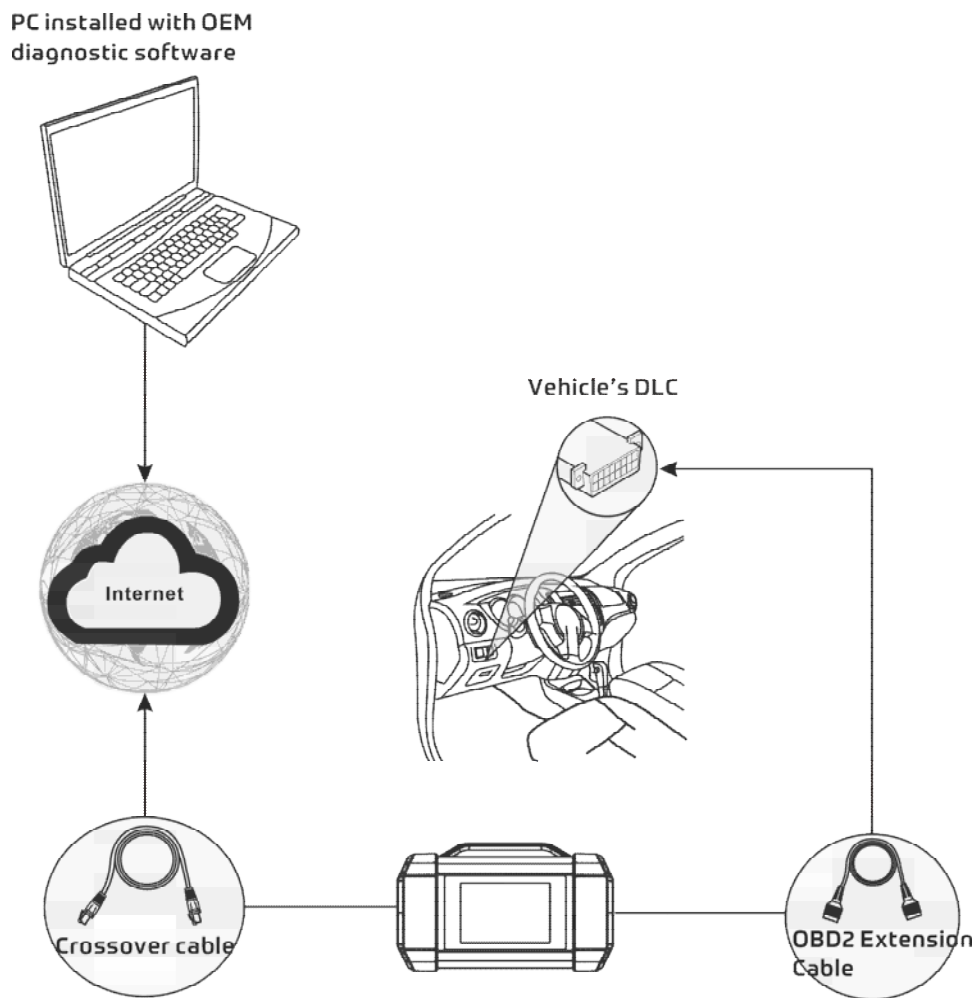

13 Synchronization

You can transfer media files and APK between the tablet and a computer.

1. Connect the tablet to a computer via the included USB cable.
2. Swipe the screen from the top, tap  -> **USB Management**.

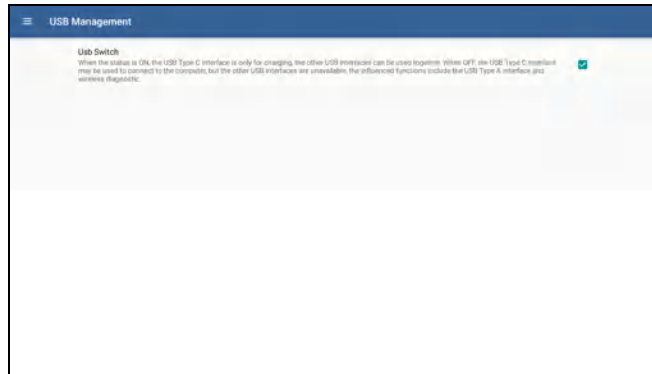

3. Deselect the USB Switch.
4. Swipe the screen from the top, tap , the following screen will appear:

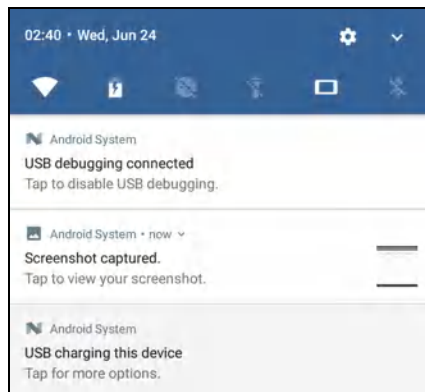

5. Tap **USB charging this device**, the following screen will appear:



6. Select **Transfer files**. Now you can copy files between the tablet and the computer.

14 FAQ

1. How to save power?

- Please turn off the screen while the tool keeps idle.
- Set a shorter standby time.
- Decrease the brightness of the screen.
- If WLAN connection is not required, please turn it off.

2. Communication error with vehicle ECU?

Please confirm:

1. Whether the VCI is correctly connected.
2. Whether ignition switch is ON.
3. If all checks are normal, send vehicle year, make, model and VIN number to us using Feedback feature.

3. Failed to enter into vehicle ECU system?

Please confirm:

1. Whether the vehicle is equipped with this system.
2. Whether the VCI is correctly connected.
3. Whether ignition switch is ON.
4. If all checks are normal, send vehicle year, make, model and VIN number to us using Feedback feature.

4. How to reset the tablet?

 **Warning:** Resetting may cause data loss. Before doing so, please make sure important data and information has been backed up.

Do the following to reset the tablet:

1. Tap **Settings** -> **Back & Reset**.
2. Tap **Factory data reset**.
3. Tap **Reset tablet**.
4. Tap **Clear all data** to start resetting until the tool automatically reboots.

5. How to download the X-431 PAD V ELITE App after resetting the tablet?

 **Note:** Before registration, please make sure the network is properly connected.

After the tablet has been successfully reset, follow the steps below to download the App:

1. Launch the browser and the default official Launch website opens (If a blank page pops up, just type in www.x431.com in the input bar).
2. Tap **Login**, input the username and password and tap **Log In**.
3. Make sure that the serial number is correct, tap **APP application program** and tap the Download icon to start downloading.
4. After the download is complete, follow the on-screen instructions to install it.
5. After installation, use the existing username and password to login and go to update center to download the diagnostic software.

6. What to do if the language of vehicle diagnostic software does not match the system language?

English is the default system language of the tool. After the system language is set to the preference language, please go to the update center to download the vehicle diagnostic software of the corresponding language.

If the downloaded diagnostic software is still displayed in English, it indicates that the software of the current language

is under development.

7. How to retrieve the login password?

Please follow below steps to proceed in case you forgot the login password:

1. Tap the application icon on the home screen to launch it.
2. Tap the **Login** button on the upper right corner of the screen.
3. Tap **Retrieve password**.
4. Input product S/N and follow the on-screen prompts to retrieve the password.

Warranty

THIS WARRANTY IS EXPRESSLY LIMITED TO PERSONS WHO PURCHASE LAUNCH PRODUCTS FOR PURPOSES OF RESALE OR USE IN THE ORDINARY COURSE OF THE BUYER'S BUSINESS.

LAUNCH electronic product is warranted against defects in materials and workmanship for one year from date of delivery to the user.

This warranty does not cover any part that has been abused, altered, used for a purpose other than for which it was intended, or used in a manner inconsistent with instructions regarding use. The exclusive remedy for any automotive meter found to be defective is repair or replacement, and LAUNCH shall not be liable for any consequential or incidental damages.

Final determination of defects shall be made by LAUNCH in accordance with procedures established by LAUNCH. No agent, employee, or representative of LAUNCH has any authority to bind LAUNCH to any affirmation, representation, or warranty concerning LAUNCH automotive meters, except as stated herein.

Disclaimer

The above warranty is in lieu of any other warranty, expressed or implied, including any warranty of merchantability or fitness for a particular purpose.

Purchase Order

Replaceable and optional parts can be ordered directly from your LAUNCH authorized tool supplier. Your order should include the following information:

Order quantity

Part number

Part name

Customer Service

If you have any questions on the operation of the unit, please contact local dealer, or contact **LAUNCH TECH CO., LTD.:**

Website: www.x431.com

www.cnlaunch.com

Phone: +86 755 2593 8674

Email: DOD@cnlaunch.com

Statement:

LAUNCH reserves the rights to make any change to product designs and specifications without notice. The actual object may differ a little from the descriptions in the manual in physical appearance, color and configuration. We have tried our best to make the descriptions and illustrations in the manual as accurate as possible, and defects are inevitable, if you have any question, please contact local dealer or after-sale service center of LAUNCH, LAUNCH does not bear any responsibility arising from misunderstandings.