

Trademarks

Autel®, MaxiSys®, MaxiDAS®, MaxiScan®, MaxiTPMS®, MaxiRecorder®, and MaxiCheck® are trademarks of Autel Intelligent Technology Corp., Ltd., registered in China, the United States and other countries. All other marks are trademarks or registered trademarks of their respective holders.

Copyright Information

No part of this manual may be reproduced, stored in a retrieval system or transmitted, in any form or by any means, electronic, mechanical, photocopying, recording, or otherwise without the prior written permission of Autel.

Disclaimer of Warranties and Limitation of Liabilities

All information, specifications and illustrations in this manual are based on the latest information available at the time of printing.

Autel reserves the right to make changes at any time without notice. While information of this manual has been carefully checked for accuracy, no guarantee is given for the completeness and correctness of the contents, including but not limited to the product specifications, functions, and illustrations.

Autel will not be liable for any direct, special, incidental, indirect damages or any economic consequential damages (including lost profits).

IMPORTANT

Before operating or maintaining this unit, please read this manual carefully, paying extra attention to the safety warnings and precautions.

For Services and Support:



pro.autel.com
www.autel.com



1-855-288-3587/1-855-AUTELUS (North America)
0086-755-86147779 (China)



support@autel.com

For details, please refer to the *Service Procedures* in this manual.

Safety Information

For your own safety and the safety of others, and to prevent damage to the device and vehicles upon which it is used, it is important that the safety instructions presented throughout this manual be read and understood by all persons operating or coming into contact with the device.

There are various procedures, techniques, tools, and parts for servicing vehicles, as well as in the skill of the person doing the work. Because of the vast number of test applications and variations in the products that can be tested with this equipment, we cannot possibly anticipate or provide advice or safety messages to cover every circumstance. It is the automotive technician's responsibility to be knowledgeable of the system being tested. It is crucial to use proper service methods and test procedures. It is essential to perform tests in an appropriate and acceptable manner that does not endanger your safety, the safety of others in the work area, the device being used, or the vehicle being tested.

Before using the device, always refer to and follow the safety messages and applicable test procedures provided by the manufacturer of the vehicle or equipment being tested. Use the device only as described in this manual. Read, understand, and follow all safety messages and instructions in this manual.

Safety Messages

Safety messages are provided to help prevent personal injury and equipment damage. All safety messages are introduced by a signal word indicating the hazard level.

DANGER

Indicates an imminently hazardous situation which, if not avoided, will result in death or serious injury to the operator or to bystanders.

WARNING

Indicates a potentially hazardous situation which, if not avoided, could result in death or serious injury to the operator or to bystanders.

Safety Instructions

The safety messages herein cover situations Autel is aware of. Autel cannot know, evaluate or advise you as to all of the possible hazards. You must be certain that any condition or service procedure encountered does not jeopardize your personal safety.

DANGER

When an engine is operating, keep the service area WELL VENTILATED or attach a building exhaust removal system to the engine exhaust system. Engines produce carbon monoxide, an odorless, poisonous gas that causes slower reaction time and can lead to serious personal injury or loss of life.

It is not advised to use headphones at a high volume

Listening at high volumes for long periods of time may result in loss of hearing.

Safety Warnings

- Always perform automotive testing in a safe environment.
- Wear safety eye protection that meets ANSI standards.
- Keep clothing, hair, hands, tools, test equipment, etc. away from all moving or hot engine parts.
- Operate the vehicle in a well-ventilated work area, for exhaust gases are poisonous.
- Put the transmission in PARK (for automatic transmission) or NEUTRAL (for manual transmission) and make sure the parking brake is engaged.
- Put blocks in front of the drive wheels and never leave the vehicle unattended while testing.
- Be extra cautious when working around the ignition coil, distributor cap, ignition wires and spark plugs. These components create hazardous voltages when the engine is running.
- Keep a fire extinguisher suitable for gasoline, chemical, and electrical fires nearby.
- Do not connect or disconnect any test equipment while the ignition is on or the engine is running.
- Keep the test equipment dry, clean, free from oil, water or grease. Use a mild detergent on a clean cloth to clean the outside of the equipment as necessary.
- Do not drive the vehicle and operate the test equipment at the same time. Any distraction may cause an accident.
- Refer to the service manual for the vehicle being serviced and adhere to all diagnostic procedures and precautions. Failure to do so may result in personal injury or damage to the test equipment.
- To avoid damaging the test equipment or generating false data, make sure the vehicle battery is fully charged and the connection to the vehicle DLC is clean and secure.
- Do not place the test equipment on the distributor of the vehicle. Strong electro-magnetic interference can damage the equipment.

CONTENTS

SAFETY INFORMATION	ii
<i>Safety Messages</i>	<i>ii</i>
SAFETY INSTRUCTIONS	ii
<i>Safety Warnings</i>	<i>iii</i>
1 USING THIS MANUAL	1
1.1 CONVENTIONS	1
1.1.1 <i>Bold Text</i>	1
1.1.2 <i>Notes and Important Messages</i>	1
1.1.3 <i>Hyperlink</i>	2
1.1.4 <i>Illustrations</i>	2
1.1.5 <i>Procedures</i>	2
2 GENERAL INTRODUCTION	3
2.1 MAXISYS TABLET	3
2.1.1 <i>Functional Description</i>	3
2.1.2 <i>Power Sources</i>	5
2.1.3 <i>Technical Specifications</i>	6
2.2 MAXIFLASH VCMI – VEHICLE COMMUNICATION AND MEASUREMENT INTERFACE	8
2.2.1 <i>Functional Description</i>	8
2.2.2 <i>Power Sources</i>	11
2.2.3 <i>Technical Specifications</i>	11
2.3 ACCESSORIES KIT	12
2.3.1 <i>Main Cable</i>	12
2.3.2 <i>OBD I-Type Adapters</i>	12
2.3.3 <i>Other Accessories</i>	13
3 GETTING STARTED	15
3.1 POWER UP	15
3.1.1 <i>Application Buttons</i>	16
3.1.2 <i>Locator and Navigation Buttons</i>	17
3.1.3 <i>System Status Icons</i>	18
3.2 POWER DOWN	18
3.2.1 <i>Reboot System</i>	19
4 DIAGNOSTICS	20
4.1 ESTABLISH VEHICLE COMMUNICATION AND SELECTION	20
4.1.1 <i>Establish Vehicle Communication</i>	20

4.1.2	<i>Getting Started</i>	24
4.1.3	<i>Vehicle Identification</i>	26
4.2	DIAGNOSTICS SCREEN LAYOUT	30
4.2.1	<i>Diagnostics Screen Layout</i>	30
4.2.2	<i>Screen Messages</i>	34
4.2.3	<i>Making Selections</i>	34
4.3	AUTO SCAN AND CONTROL UNIT	35
4.3.1.	<i>Auto Scan</i>	35
4.3.2.	<i>Control Unit</i>	38
4.4	ECU INFORMATION	39
4.5	TROUBLE CODES	40
4.5.1	<i>Read Codes</i>	40
4.5.2	<i>Erase Codes</i>	42
4.6	LIVE DATA	42
4.7	ACTIVE TEST	50
4.8	SPECIAL FUNCTIONS	50
4.9	PROGRAMMING AND CODING	52
4.9.1	<i>Coding</i>	53
4.9.2	<i>Reprogramming</i>	53
4.9.3	<i>Re-flash Errors</i>	54
4.10	GENERIC OBD II OPERATIONS	55
4.10.1	<i>General Procedure</i>	55
4.10.2	<i>Function Descriptions</i>	56
4.11	DIAGNOSTIC REPORT	59
4.11.1	<i>Pre-Scan and Post-Scan</i>	59
4.11.2	<i>Diagnostic Report PDF</i>	59
4.12	EXIT DIAGNOSTICS	63
5	INTELLIGENT DIAGNOSTICS	64
5.1	ACCESSING INTELLIGENT DIAGNOSTICS FUNCTION	64
5.1.1	<i>Auto Scan</i>	64
5.1.2	<i>Scan System Faults</i>	66
5.1.3	<i>Access via Intelligent Diagnostics Button</i>	68
5.1.4	<i>Access via Intelligent Diagnostics Icon</i>	69
5.2	INTELLIGENT DIAGNOSTICS OPERATION	72
5.2.1	<i>Vehicle System and Detected DTC(s)</i>	73

5.2.2	Technical Service Bulletin (OEM Information)	74
5.2.3	DTC Analysis	74
5.2.4	Repair Assist	75
5.2.5	Repair Tips	81
5.2.6	Component Measurement	82
5.2.7	Relevant Cases	82
6	SERVICE	84
6.1	OIL RESET SERVICE	84
6.2	ELECTRIC PARKING BRAKE (EPB) SERVICE	85
6.2.1	EPB Safety	85
6.3	TIRE PRESSURE MONITORING SYSTEM (TPMS) SERVICE	85
6.4	BATTERY MANAGEMENT SYSTEM (BMS) SERVICE	86
6.5	DIESEL PARTICLE FILTER (DPF) SERVICE	86
6.6	IMMOBILIZER (IMMO) SERVICE	87
6.7	STEERING ANGLE SENSOR (SAS) SERVICE	88
7	MEASUREMENT	89
7.1	OSCILLOSCOPE	89
7.1.1	Safety Information	89
7.1.2	General Introduction	91
7.1.3	Getting Started	96
7.1.4	Oscilloscope Update	97
7.1.5	Screen Layout and Operations	100
7.1.6	Troubleshooting	169
7.1.7	Glossary	170
7.2	MULTIMETER	172
7.2.1	Safety Information	172
7.2.2	General Introduction	173
7.2.3	Getting Started	176
7.2.4	Multimeter Update	176
7.2.5	Screen Layout and Operations	178
7.2.6	Troubleshooting	196
7.2.7	Glossary	197
7.3	WAVEFORM GENERATOR	198
7.3.1	Safety Information	198
7.3.2	General Introduction	199

7.3.3	<i>Getting Started</i>	201
7.3.4	<i>Waveform Generator Update</i>	202
7.3.5	<i>Screen Layout and Operations</i>	204
7.3.6	<i>Troubleshooting</i>	224
7.3.7	<i>Glossary</i>	224
7.4	OBDII CAN BUS CHECK	226
7.4.1	<i>Safety Information</i>	226
7.4.2	<i>General Introduction</i>	227
7.4.3	<i>Getting Started</i>	227
7.4.4	<i>OBDII CAN Bus Check Update</i>	228
7.4.5	<i>Screen Layout and Operations</i>	230
7.4.6	<i>Troubleshooting</i>	250
7.4.7	<i>Glossary</i>	250
8	DATA MANAGER	253
8.1	VEHICLE HISTORY	254
8.1.1	<i>Historical Test Record</i>	255
8.2	WORKSHOP INFORMATION	256
8.3	CUSTOMER	257
8.4	IMAGE	258
8.5	PDF FILES	259
8.6	REVIEW DATA	259
8.7	UNINSTALL APPS	260
8.8	DATA LOGGING	260
9	SETTINGS	261
9.1	OPERATIONS	261
9.1.1	<i>Unit</i>	261
9.1.2	<i>Language</i>	262
9.1.3	<i>Printing Settings</i>	262
9.1.4	<i>Notification Center</i>	263
9.1.5	<i>Auto Update</i>	264
9.1.6	<i>ADAS Registration</i>	264
9.1.7	<i>Vehicle List</i>	264
9.1.8	<i>Country Code</i>	265
9.1.9	<i>System Settings</i>	265
9.1.10	<i>About</i>	265

10	UPDATE	266
11	VCFI MANAGER.....	268
11.1	WI-FI CONNECTION	269
11.2	BT PAIRING	270
11.3	UPDATE	271
12	ADAS.....	273
13	SUPPORT	274
13.1	PRODUCT REGISTRATION.....	274
13.2	SUPPORT SCREEN LAYOUT	275
13.3	MY ACCOUNT	275
13.3.1	<i>Personal Info</i>	275
13.3.2	<i>Update Info</i>	276
13.3.3	<i>Service Info</i>	276
13.4	COMPLAINT	276
13.4.1	<i>Screen Layout</i>	276
13.5	DATA LOGGING	277
13.6	TRAINING	278
13.7	FAQ DATABASE.....	278
14	REMOTE DESKTOP	279
14.1	OPERATIONS	279
15	QUICK LINK	281
16	MAXVIEWER.....	282
17	MAXIVIDEO.....	284
17.1	ADDITIONAL ACCESSORIES.....	285
17.1.1	<i>MaxiVideo Camera</i>	285
17.1.2	<i>Imager Head Accessories</i>	286
17.1.3	<i>Accessory Assembly</i>	286
17.1.4	<i>Technical Specifications</i>	288
17.2	OPERATIONS	288
18	MAINTENANCE AND SERVICE	290
18.1	MAINTENANCE INSTRUCTIONS.....	290
18.2	TROUBLESHOOTING CHECKLIST	290
18.3	ABOUT BATTERY USAGE	291
18.4	SERVICE PROCEDURES.....	292
18.4.1	<i>Technical Support</i>	292

18.4.2	<i>Repair Service</i>	293
18.4.3	<i>Other Services</i>	294
19	COMPLIANCE INFORMATION	295
20	WARRANTY	297
20.1	12-MONTH LIMITED WARRANTY	297

1 Using This Manual

This manual contains device usage instructions.

Some illustrations shown in this manual may contain modules and optional equipment that are not included in your system.

1.1 Conventions

The following conventions are used.

1.1.1 Bold Text

Bold text is used to highlight selectable items such as buttons and menu options.

Example:

- Tap **OK**.

1.1.2 Notes and Important Messages

Notes

A **NOTE** provides helpful information such as additional explanations, tips, and comments.

Example:

 **NOTE**
New batteries reach full capacity after approximately 3 to 5 charging and discharging cycles.

Important

IMPORTANT indicates a situation which that if not avoided may result in damage to the tablet or vehicle.

Example:

 **IMPORTANT**
Keep the cable away from heat, oil, sharp edges and moving parts. Replace damaged cables immediately.

1.1.3 Hyperlink

Hyperlinks or links that take you to other related articles, procedures, and illustrations are available in electronic documents. Blue italic text indicates a selectable hyperlink and blue underlined text indicates a website link or an email address link.

1.1.4 Illustrations

Illustrations used in this manual are samples, and the actual testing screen may vary for each vehicle being tested. Observe the menu titles and on-screen instructions to make correct option selection.

1.1.5 Procedures

An arrow icon indicates a procedure.

Example:

➤ **To use the camera:**

1. Tap the **Camera** button. The camera screen opens.
2. Focus the image to be captured in the view finder.
3. Tap the camera icon on the right side of the screen. The view finder now shows the captured picture and auto-saves the taken photo.
4. Tap the thumbnail image on the top right corner of the screen to view the stored image.
5. Tap the **Back** or **Home** button to exit the camera application.

2 General Introduction

The MaxiSys Ultra is a multi-platform diagnostic solution comprised of a powerful 12.9-inch TFT-LCD touchscreen Android-based tablet, a VCMI communication and diagnostic measurement unit and an on-tool and cloud-based repair instructions and expert advice. As an intelligent diagnostic and information system, MaxiSys Ultra not only displays the relevant repairs gathered from experienced industry experts, but provides step-by-step guidance to ensure the repair is done correctly and efficiently.

There are two main components to the MaxiSys system:

- MaxiSys Tablet – the central processor and monitor for the system.
- MaxiFlash VCMI - Vehicle Communication and Measurement Interface

This manual describes the construction and operation of these devices and how they work together to deliver diagnostic solutions.

2.1 MaxiSys Tablet

2.1.1 Functional Description

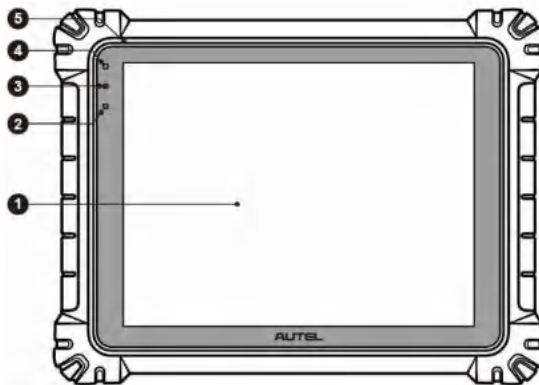

Figure 2-1 MaxiSys Tablet Front View

1. 12.9" TFT-LCD Capacitive Touch Screen
2. Ambient Light Sensor – detects ambient brightness
3. Power LED - refer to Table 2-1 Power LED Description for details
4. Front Camera
5. Built-in Microphone

Table 2-1 Power LED Description

LED	Color	Description
Power	Green	<ul style="list-style-type: none"> Lights green when the Tablet is charging and the battery level is above 90%. Lights green when the Tablet is powered on and the battery level is above 15%
	Yellow	Lights yellow when the Tablet is charging and the battery level is below 90%.
	Red	Lights red when the Tablet is powered on and the battery level is below 15%.

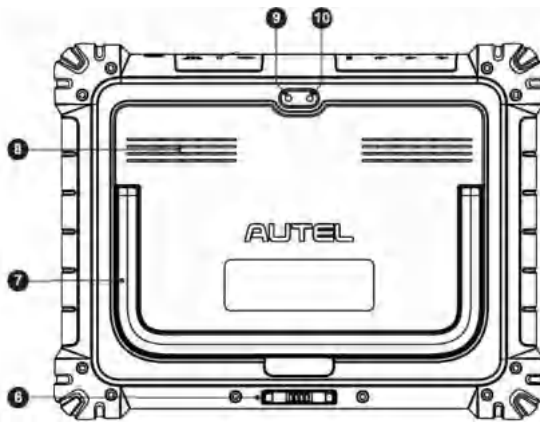

Figure 2-2 MaxiSys Tablet Back View

- 6. Docking Station Port
- 7. Collapsible Stand – extends from the back to allow hands-free viewing of the tablet
- 8. Speaker
- 9. Rear Camera
- 10. Camera Flash

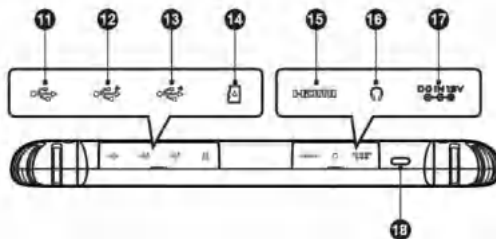

Figure 2-3 MaxiSys Tablet Top Side

- 11. Mini USB Port – Cannot be used with the USB Port simultaneously

12. USB Port
13. USB Port
14. Mini SD Card Slot
15. HDMI (High-Definition Multimedia Interface) Port
16. Head Phone Jack
17. DC Power Supply Input Port
18. Lock/Power Button – long press to turn on and off the Tablet, or short press to lock the screen.

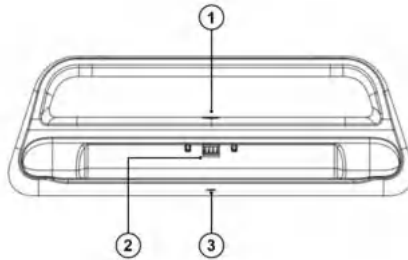

Figure 2-4 Docking Station

1. DC Power Port – connects to the AC/DC adapter for power supply
2. Charging Dock – holds the MaxiSys tablet for optimum viewing and convenient charging
3. Status Indicator Light

The Indicator Light displays differently in response to the tablet status described below:

- A. Green light – battery power of the tablet is sufficient ($\geq 90\%$)
- B. Yellow light – battery level is above 14% but below 90%
- C. Red light – battery level is below 14%

NOTE

Ensure the charging dock is clear of any small metal or other conductive parts to avoid short circuit damage to the charger and the tablet.

2.1.2 Power Sources

The tablet can receive power from any of the following sources:

- Internal Battery Pack
- AC/DC Power Supply

- Vehicle Power

! IMPORTANT

Do not charge the battery when the temperature is lower than 0°C (32°F) or higher than 45°C (113°F).

Internal Battery Pack

The tablet can be powered with the internal rechargeable battery, which if fully charged can provide sufficient power for about 8 hours of continuous operation.

AC/DC Power Supply – using power adapter or docking station

The tablet can be powered from an electrical outlet using the AC/DC power adapter or the docking station. The AC/DC power supply also charges the internal battery pack.

Vehicle Power

The tablet can be powered from the cigarette lighter or other DC power port on the test vehicle through a direct cable connection. The vehicle power cable connects to the DC power supply port on the top side of the display unit.

2.1.3 Technical Specifications

Table 2-2 Tablet Specifications

Item	Description
Operating System	Android 7.0
Processor	Samsung Exynos8895V octa-core Processor (2.3GHz Quad-core Mongoose + 1.7GHz Quad-core A53)
Memory	4GB RAM & 256GB On-board Memory
Display	12.9 inch TFT-LCD with 2732 x 2048 resolution & capacitive touch screen
Connectivity	<ul style="list-style-type: none"> ● WiFix2 (802.11 a/b/g/n/ac 2x2 MIMO) ● BT v.2.1 + EDR ● GPS ● USB 2.0 (Two USB HOST Type A, one USB mini device) ● HDMI 2.0 ● SD Card (Support up to 256GB)
Camera	<ul style="list-style-type: none"> ● Rear: 16 Megapixel, Autofocus with Flashlight ● Front: 5 Megapixel

Item	Description
Sensors	Gravity Accelerometer, Ambient Light Sensor (ALS)
Audio Input / Output	<ul style="list-style-type: none"> ● Microphone ● Dual Speakers ● 3-Band 3.5 mm stereo/standard headset jack
Power and Battery	<ul style="list-style-type: none"> ● 18000mAh 3.8 V lithium-polymer battery ● Charging via 12 V AC/DC power supply with the temperature between 0°C and 45°C
Input Voltage	12V/3A Adapter
Operating Temp.	0 to 50°C (32 to 122°F)
Storage Temp.	-20 to 60°C (-4 to 140°F)
Dimensions (WxHxD)	366.5 mm (14.43") x 280.9 mm (11.06") x 34 mm (1.34")
Weight	2.18kg (4.81 lb.)
Protocols	DoIP, PLC J2497, ISO-15765, SAE-J1939, ISO-14229 UDS, SAE-J2411 Single Wire Can (GMLAN), ISO-11898-2, ISO-11898-3, SAE-J2819 (TP20), TP16, ISO-9141, ISO-14230, SAE-J2610 (Chrysler SCI), UART Echo Byte, SAE-J2809 (Honda Diag-H), SAE-J2740 (GM ALDL), SAE-J1567 (CCD BUS), Ford UBP, Nissan DDL UART with Clock, BMW DS2, BMW DS1, SAE J2819 (VAG KW81), KW82, SAE J1708, SAE-J1850 PWM (Ford SCP), SAE-J1850 VPW (GM Class2)

Table 2-3 Docking Station Specifications

Item	Description
Input Voltage	DC/12V/3A
Operating Temperature	0°C to +45°C (ambient)
Storage Temperature	-20°C to +60°C (ambient)
Dimensions (L x W x H)	396 x 136 x 54 (mm)
Weight	0.98kg (2.1605lb.)

2.2 MaxiFlash VCMi – Vehicle Communication and Measurement Interface

2.2.1 Functional Description

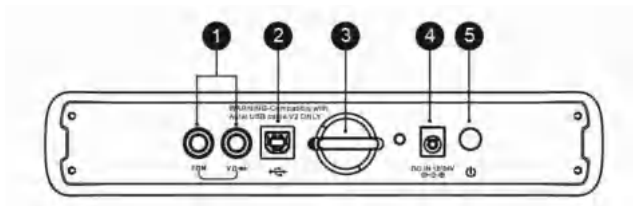

Figure 2-5 VCMi Top View

1. Multimeter Jacks
2. USB Port
3. Hook
4. DC Power Supply Input Port
5. Power Button

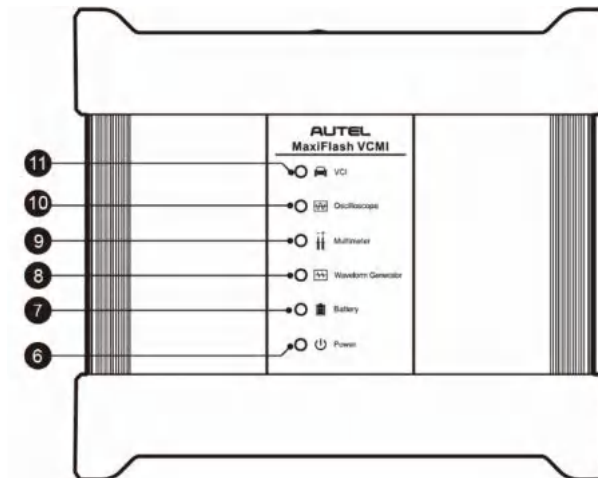

Figure 2-6 VCMi Front View

6. Power LED – refer to Table 2-4 Power LED Description for details
7. Battery LED - refer to Table 2-5 Battery LED Description for details
8. Waveform generator LED - lights green when operating in the waveform generator mode
9. Multimeter LED - lights green when operating in the multimeter mode

10. Oscilloscope LED - flashes green when operating in the oscilloscope mode

11. Vehicle LED - refer to Table 2-6 Vehicle LED Description for details

! IMPORTANT

Do not disconnect the programming device while the vehicle LED status light is on! If the flash programming procedure is interrupted while the vehicle's ECU is blank or only partially programmed, the module may be unrecoverable.

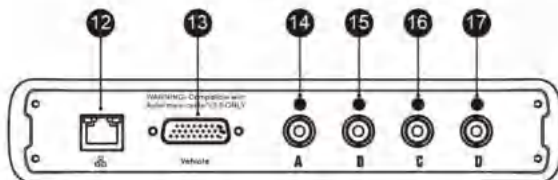

Figure 2-7 VCMI Bottom View

12. Ethernet Port

13. Vehicle Data Connector (DB26-Pin)

14. Input Channel A

15. Input Channel B

16. Input Channel C

17. Input Channel D

Table 2-4 Power LED Description

LED	Color	Description
Power	Yellow	Lights yellow automatically at power up when VCMI is self-testing.
	Green	Lights solid green when powered on.
	Red	<ul style="list-style-type: none">● Lights solid red when system failure occurs.● Flashes red when VCMI is upgrading.

Table 2-5 Battery LED Description

LED	Color	Description
Battery	Green	<ul style="list-style-type: none">● Flashes green when VCMI is charging.● Lights solid green when fully charged or the battery level is above 50%.

LED	Color	Description
	Yellow	Lights yellow when the battery level is above 25% but below 50%.
	Red	<ul style="list-style-type: none"> ● Lights red when the battery level is above 10% but below 25%. ● Flashes red when the battery level is below 10%.

Table 2-6 Vehicle LED Description

LED	Color	Description
Vehicle	Green	Lights solid green when connected via USB cable. Flashes green when communicating.
	Blue	Lights solid blue when connected via BT. Flashes blue when communicating.
	Cyan (Blue/Green)	Lights solid cyan when connected via Wi-Fi. Flashes cyan (blue/green) when communicating.
	Magenta (Blue/Red)	Lights solid magenta when connected via Internet cable. Flashes magenta (blue/red) when communicating.

NOTE

Sometimes the vehicle LED lights yellow when the VCMI device is connected by other tablets, please wait for 2 minutes to automatically disconnect them, or when the Wi-Fi signal is weak, please try to reconnect the VCMI.

Communication Capability

The Vehicle Communication and Measurement Interface supports Bluetooth (BT), Wi-Fi and USB communications. It can transmit vehicle data to the tablet with or without a cable connection. In open areas, the working range of the transmitter through BT communication is up to 328 feet (100 m). The working range of 5G Wi-Fi is up to 164 feet (50 m). If the signal is lost due to being taken out of range, communication will be restored once the tablet is within range.

Measurement Capability

The VCMI device is designed with the functions of multimeter, oscilloscope, waveform generator and OBDII CAN Bus Check. The parameters such as voltage, resistance, current, signal frequency, and voltage-time characteristic of the signal can be measured and the results are displayed on the tablet.

Programming Capability

The VCMI device is a D-PDU, SAE J2534 & RP1210 compliant PassThru programming interface device. Using the updated OEM software, it is capable of replacing the existing software/firmware in the Electronic Control Units (ECU), programming new ECUs and fixing software-controlled drivability issues and emission issues.

2.2.2 Power Sources

The VCMI device can receive power from the following sources:

- Vehicle Power
- AC/DC Power Supply
- Built-in rechargeable Battery Pack

Vehicle Power

The VCMI device operates on 12/24 Volt vehicle power, which receives power via the vehicle data connection port. The device powers on whenever it is connected to an OBD II/EODB compliant data link connector (DLC). For non OBD II/EODB compliant vehicles, the device can be powered from a cigarette lighter or other suitable power port on the test vehicle using the auxiliary power cable.

AC/DC Power Supply

The VCMI device can be powered from a wall socket using the AC/DC power adapter.

Built-in Battery Pack

The VCMI device can also be powered with its built-in 3750mAh battery pack.

2.2.3 Technical Specifications

Table 2-7 VCMI Specifications

Item	Description
Communications	<ul style="list-style-type: none">● BT V2.1 + EDR● USB 2.0● Wi-Fi 5G● Ethernet
Wireless Frequency	5GHz
Power and Battery	<ul style="list-style-type: none">● 3750 mAh lithium-polymer battery● Charging via 12 V DC power supply
Operating Temp.	0°C to 50°C

Item	Description
Storage Temp.	-20°C to 60°C
Dimensions (L x W x H)	214 mm (8.43") x 192 mm (7.56") x 39 mm (1.54")
Weight	1.2kg (2.64 lb.)

Note

For additional information, please refer to the accompanied user manual for the VCMI device.

2.3 Accessories Kit

2.3.1 Main Cable

The VCMI device can be powered through the Autel Main Cable V2.0 (the V2.0 icon can be seen on the cable) when connected to an OBD II/E/OBD compliant vehicle. The Main Cable connects the VCMI device to the vehicle's data link connector (DLC), through which the VCMI device can transmit vehicle data to the tablet.

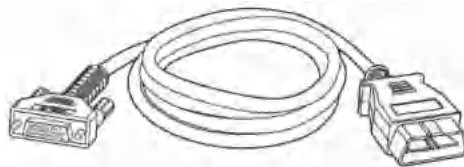

Figure 2-8 Main Cable – 2 m in length

Note

MaxiFlash VCMI and MaxiFlash VCI can be connected by the Autel Main Cable V2.0 only. DO NOT use other Autel main cables to connect the MaxiFlash VCMI and MaxiFlash VCI.

2.3.2 OBD I-Type Adapters

The OBD I-type adapters are for Non-OBDII vehicles. The adapter used depends on the type of vehicle being tested. The most common adapters are shown below (Adapters may be sold separately, please contact your distributor for details).



Benz-14



Chrysler-16



BMW-20



Nissan-14



Kia-20



Fiat-3



PSA-2



Mazda-17



VW/Audi-2+2



Benz-38



Mitsubishi/Hyundai-12+16

2.3.3 Other Accessories



Docking Station

Provides power to the tablet.



Autel USB Cable V2 (the V2 icon can be seen on the cable)

Connects the tablet to the VCMI unit.



AC/DC External Power Adapter

Connects the tablet to the external DC power port for power supply.



Cigarette Lighter

Provides power to the tablet or the VCMI device through connection to the vehicle's cigarette lighter receptacle, as some non-OBD II vehicles cannot provide power via the DLC connection.



Clipper Cable

Provides power to the tablet or the VCMI device through connection to the vehicle's battery.



Lighter Fuse x2

A safety device for the cigarette lighter.

3 Getting Started

Make sure the tablet has sufficient power or is connected to the external power supply (see [Power Sources](#) on page 5).

3.1 Power Up

Long press (press and hold) the Lock/Power button on the top right side of the tablet to switch the unit on. The system boots up and shows the lock screen with 3 entry options:

1. MaxiSys Home – Swipes up the MaxiSys Home icon to enter the MaxiSys Job Menu shown as below.
2. Unlock – Swipes up the Lock icon at the center to unlock the screen or enter the MaxiSys Job Menu when booting up.
3. Camera – Swipes up the Camera icon to launch the camera.



Figure 3-1 Sample MaxiSys Job Menu

1. Application Buttons
2. Locator and Navigation Buttons
3. Status Icons

NOTE











It is recommended to lock the screen when not in use to protect information in the system and conserve the power.



Almost all operations on the tablet are controlled through the touchscreen. The touchscreen navigation is menu driven allowing for quick access you to test procedure, or data that you need, through a series of questions and options. Detailed descriptions of the menu structures are found in the chapters for each application.

3.1.1 Application Buttons

The table below briefly describes each of the applications in the MaxiSys system.

Table 3-1 Applications







Name	Button	Description
Diagnostics		Accesses the unit's diagnostics functions. See Diagnostics on page 20.
Service		Accesses special functions menu. See Service on page 84.
Measurement		Software tools that measure vehicle system parameters such as voltage, resistance, current, and monitor signal activities. See Measurement on page 89.
Data Manager		Accesses the saved repair shop, customer and vehicle data including detail vehicle diagnostics and test record history. See Data Manager on page 253.
Settings		Accesses the system settings menu and general tablet menu. See Settings on page 261.
Update		Accesses system software update menu. See Update on page 266.
VCMI Manager		Accesses VCMI connection menu. See VCMI Manager on page 268.
ADAS		Accesses ADAS systems menu. See ADAS on page 273.
Support		Synchronizes Autel's online service database with the MaxiSys tablet. See Support on page 274.
Remote Desktop		Configures your unit to receive remote support using the TeamViewer application. See Remote Desktop on page 279.





Name	Button	Description
Quick Link		Provides associated website bookmarks to allow quick access to product update, service, support and other information. See Quick Link on page 281.
MaxiViewer		Provides a quick search for supported functions and/or vehicles. See MaxiViewer on page 282.
MaxiVideo		Configures the unit to operate as a video scope device by connecting to an Imager head cable for close vehicle inspections. See MaxiVideo on page 284.

3.1.2 Locator and Navigation Buttons

Operations of the Navigation buttons at the bottom of the screen are described in the table below:

Table 3-2 Locator and Navigation Buttons

Name	Button	Description
Locator		Indicates the location of the screen. Swipe the screen left or right to view the previous or next screen.
Back		Returns to the previous screen.
Android Home		Returns to Android System's Home screen.
Recent Apps		Displays a list of applications that are currently running. Tap an app icon to launch. Remove an app by swiping it to the right.
Split Screen		Tap icon to display a split screen.
Browser		Launches the Chrome Internet browser.
Camera		Tap icon to open camera viewfinder. Press and hold icon to capture screenshot of display screen. The saved files are auto-stored in the Data Manager application for later review. See Data Manager on page 253.

Name	Button	Description
Display & Sound		Adjusts the brightness of the screen and the volume of the audio output.
MaxiSys Home		Returns to MaxiSys Job Menu.
VCMI		Opens the VCMI Manager application. A green icon at the bottom right corner indicates the VCMI device is connected, a red X icon will display if connection fails. The battery status icon displays the remaining VCMI power.
MaxiSys Shortcut		Returns to the Diagnostics screen.
Service		Returns to the Service screen.

➤ **To use the camera**

1. Tap the **Camera** button. The camera screen opens.
2. Focus the image to be captured in the view finder.
3. Tap the camera icon on the right side of the screen. The view finder now shows the captured picture and auto-saves the taken photo.
4. Tap the thumbnail image on the top right corner of the screen to view the stored image.
5. Tap the **Back** or **Home** button to exit the camera application.

 **NOTE**

After swiping the camera screen from left to right, the camera mode and video mode can be switched by tapping the blue camera icon or video icon.

Refer to Android documentation for additional information.

3.1.3 System Status Icons

Your MaxiSys tablet is a fully functional Android tablet with the standard Android operation system status icons. Refer to Android documentation for additional information.

3.2 Power Down

All vehicle communications should be terminated before shutting down the tablet. A warning message displays if a shutdown is attempted while the tablet is communicating with the vehicle. Forcing a shut down while the tablet is communicating with the vehicle

may lead to ECU problems on some vehicles. Please exit the Diagnostics application before shutting off the tablet.

➤ **To power down the MaxiSys tablet**

1. Long press (press and hold) the Lock/Power Button.
2. Tap **Power off** option.
3. Tap **OK**.

3.2.1 Reboot System

In case of system crash, long press the Lock/Power button and tap **Reboot** to restart the system.

4Diagnostics

The Diagnostics application can access the electronic control module of multiple vehicle control systems, including but not limited to the engine, transmission, antilock brake system (ABS) and airbag system (SRS).

4.1 Establish Vehicle Communication and Selection

4.1.1 Establish Vehicle Communication

The Diagnostics operations require connecting the MaxiSys Ultra Diagnostic tablet to the test vehicle through the VCMI device using the Main Cable. (Use the applicable OBD I-type adapter if needed). To establish proper vehicle communication to the tablet, you need to perform the following steps:

1. Connect the VCMI device to the vehicle's DLC for both communication and power source.
2. Connect the VCMI device to the tablet via BT pairing, Wi-Fi or USB connection.
3. When the above steps are completed, check the VCMI navigation button at the bottom bar on the screen, if a green BT, Wi-Fi or USB icon displays at the lower right corner, the MaxiSys Ultra Diagnostic Platform is ready to start vehicle diagnosis.

4.1.1.1 Vehicle Connection

The method used to connect the VCMI device to a vehicle's DLC depends on the vehicle's configuration as follows:

- A vehicle equipped with an On-board Diagnostics Two (OBD II) management system supplies both communication and 12-volt power through a standardized J-1962 DLC.
- A vehicle not equipped with an OBD II management system supplies communication through a DLC connection, and in some cases supplies 12-volt power through the cigarette lighter receptacle or a connection to the vehicle battery.

OBD II Vehicle Connection

This type of connection only requires the main cable without any additional adapter.

➤ **To connect to an OBD II vehicle**

1. Connect the main cable's female adapter to the Vehicle Data Connector on the VCMI device, and tighten the captive screws.
2. Connect the cable's 16-pin male adapter to the vehicle's DLC, which is generally

located under the vehicle dash.

 **NOTE**

The vehicle's DLC is not always located under the dash; refer to the user manual of the test vehicle for additional connection information.

Non-OBD II Vehicle Connection

This type of connection requires both the main cable and a required OBD I adapter for the specific vehicle being serviced.

There are three possible conditions for Non-OBD II vehicle connection:

- DLC connection supplies both communication and power.
- DLC connection supplies communication and power is to be supplied via the cigarette lighter connection.
- DLC connection supplies communication and power is to be supplied via connection to the vehicle battery.

➤ **To connect to a Non-OBD II Vehicle**

1. Connect the main cable's female adapter to the Vehicle Data Connector on the VCMI device, and tighten the captive screws.
2. Locate the required OBD I adapter and connect its 16-pin jack to the main cable's male adapter.
3. Connect the attached OBD I adapter to the vehicle's DLC.

 **NOTE**

Some vehicles may have more than one adapter or may have test leads instead of an adapter. Make the proper connection to the vehicle's DLC as required.

➤ **To connect the cigarette lighter**

1. Plug the DC power connector of the cigarette lighter into the DC power supply input port on the device.
2. Connect the male connector of the cigarette lighter into the vehicle's cigarette lighter receptacle.

➤ **To connect the clipper cable**

1. Connect the tubular plug of the clipper cable to the male connector of the cigarette lighter.

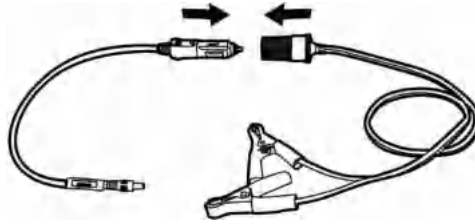

Figure 4-1 Connection between Cigarette Lighter and Clipper Cable

2. Plug the DC power connector of the cigarette lighter into the DC power supply input port of the VCMi device.
3. Connect the clipper cable to the vehicle's battery.

NOTE

After the VCMi device is successfully connected to the vehicle, the Power LED on the device lights, and a beep sound will be heard.

4.1.1.2 VCMi Connection

After the VCMi device is properly connected to the vehicle, the Power LED on the VCMi device lights solid green, and is ready to establish communication with the tablet.

Coming with the MaxiSys Ultra tool kit, the VCMi device supports three communication methods with the tablet: BT, Wi-Fi and USB.

Pairing Up via BT

In open areas, the working range for BT communication is about 328 feet (100 m), giving technicians greater mobility to perform vehicle diagnosis from anywhere in the repair shop.

To expedite multi-vehicle diagnostics, more than one VCMi can be used in busy repair shops enabling technicians to quickly pair via BT their Ultra to each VCMi separately and therefore eliminating the need to unplug the VCMi from one vehicle and then connect it to another each time.

➤ To pair the tablet with the VCMi device via BT

1. Power up the tablet.
2. Select the **VCMi Manager** application from the MaxiSys Job Menu.
3. When the **VCMi Manager** application is opened, the device automatically scans for available VCMi devices for BT pairing. The found devices are listed in the Setting section on the right side of the screen.

 **NOTE**

If no VCMI device is found, this may indicate that the signal strength is too weak to be detected. Reposition the VCMI device, and remove all possible objects that may cause signal interference. Tap the **Scan** button at the top right corner to rescan for VCMI.

4. Typically, the VCMI device name displays as Maxi suffixed with a serial number. Select the VCMI device for pairing. (If more than one VCMI is used in the shop, ensure the correct VCMI is selected to pair.)
5. When pairing is successful, the connection status displays as Connected.
6. The VCMI icon on the tablet Navigation bar at the bottom of the screen displays a green circle BT icon when the tablet and the VCMI are connected.

Refer to [BT Pairing](#) on page 270 for additional information.

Wi-Fi Connection

The VCMI device supports 5GHz Wi-Fi connection. In open areas, the working range of 5G Wi-Fi communication is up to 164 feet (50 m).

➤ **To pair the tablet with the VCMI device via Wi-Fi**

1. Power up the tablet.
2. Select the **VCMI Manager** application from the MaxiSys Job Menu.
3. When the **VCMI Manager** application is opened, the tablet automatically scans for available VCMI devices for Wi-Fi connection. Found VCMI devices are listed in the Setting section on the right side of the screen.
4. Typically, the VCMI device name displays as Maxi suffixed with a serial number. Select the required device for connection.
5. When pairing is successful, the connection status is shown as Connected.
6. The VCMI icon on the tablet Navigation bar at the bottom of the screen displays a green circle Wi-Fi icon when the tablet and the VCMI are connected.

Refer to [Wi-Fi Connection](#) on page 269 for additional information.

USB Cable Connection

After properly connecting the USB cable from the tablet to the VCMI device, the VCMI navigation button at the bottom bar of the screen displays a green check mark, and the USB LED on the VCMI device lights solid green, indicating the connection between the devices is successful.

The MaxiSys diagnostic platform is now ready to perform vehicle diagnosis.

 **NOTE**

Since the USB connection provides the most stable communication and is the recommended communication method between the tablet and VCMI when operating

ECU programming or coding. The USB communication method will take priority over other connected communication methods.

4.1.1.3 *No Communication Message*

- A. If the tablet is unable to connect to the VCMI, an "Error" message displays. An "Error" message indicates the tablet is not communicating with the VCMI device. Troubleshoot the error by performing the following steps:
- Ensure the VCMI device is powered on.
 - When using the wireless connection, ensure the network is configured correctly and the proper device has been connected.
 - If the tablet loses communication abruptly during the diagnosis, ensure no objects are causing signal interruption.
 - Ensure the VCMI device is properly positioned with the VCMI front side up.
 - Move the tablet closer to the VCMI device. If using the wired connection, ensure the cable is securely attached to the VCMI.
 - Ensure the VCMI communication mode is lit for the selected communication type: BT, Wi-Fi or USB.
- B. If the VCMI device is unable to establish a communication link, a message will display troubleshooting instructions. Possible causes for the communication error include:
- The VCMI device is unable to establish a communication link with the vehicle.
 - A vehicle system has been selected for diagnoses that is not supported by the vehicle.
 - There is a loose connection.
 - There is a blown vehicle fuse.
 - The vehicle or the data cable has a wiring fault.
 - There is a circuit fault in the data cable or adapter.
 - The vehicle identification is incorrectly entered.

4.1.2 **Getting Started**

Prior to first use of the Diagnostics application, ensure the VCMI device is properly connected to and is communicating with the tablet. See [VCMI Manager](#) on page 268.

4.1.2.1 *Vehicle Menu Layout*

When the VCMI device is properly connected to the vehicle, and paired to the tablet, the platform is ready to start vehicle diagnosis. Tap on the Diagnostics application button on the MaxiSys Job Menu, the Vehicle Menu displays on the screen.







Figure 4-2 Sample Vehicle Menu Screen







1. Top Toolbar Buttons
2. Manufacturer Buttons

Top toolbar Buttons

The operations of the Toolbar buttons at the top of the screen are listed and described in the table below:

Table 4-1 Top Toolbar Buttons

Name	Button	Description
Home		Returns to the MaxiSys Job Menu.
VID Scan		Tap this button to open a dropdown list; tap Auto Detect for auto VIN detection; tap Manual Input to enter VIN code or license number manually. Tap Scan VIN/License to scan the VIN code/license numbers by camera.
All		Displays all the vehicle makes in the vehicle menu.
Favorites		Displays user-selected favorite vehicle makes.
History		Displays the stored test vehicle history records. This option provides direct access to the previously tested vehicle recorded during previous tests. See Vehicle History on page 254.

Name	Button	Description
America		Displays the American vehicle menu.
Europe		Displays the European vehicle menu.
Asia		Displays the Asian vehicle menu.
China		Displays the Chinese vehicle menu.
Search		Tap inside the search field to display the virtual keyboard and input the vehicle manufacturer to test.
Cancel		Tap this button to exit the search screen or cancel an operation.

Manufacturer Buttons

The Manufacturer buttons display the various vehicle brand names. Select the manufacturer button after the VCMI device is properly connected to the test vehicle to start a diagnostic session.

4.1.3 Vehicle Identification

The MaxiSys diagnostic system supports five methods of Vehicle Identification.

1. Auto VIN Scan
2. Manual Input
3. Scan VIN/License
4. Manual Vehicle Selection
5. OBDII Direct Entry

4.1.3.1 Auto VIN Scan

The MaxiSys diagnostic system features the latest VIN-based Auto VIN Scan function to identify CAN vehicles in just one tap, enabling the technician to quickly identify the exact vehicle and scan its available systems for fault codes.

➤ To perform Auto VIN Scan

1. Tap the **Diagnostics** application button from the MaxiSys Job Menu. The Vehicle Menu displays.
2. Tap the **VID Scan** button on the top toolbar.
3. Select **Auto detect**. The tablet starts VIN scanning on the vehicle's ECU. Once the test vehicle is successfully identified, the system will guide you to the Vehicle Diagnostics screen.



Figure 4-3 Sample Auto Detect Screen

Depending on the vehicle, the Auto VIN function is still available after a vehicle brand is selected.



Figure 4-4 Sample Vehicle Selection Screen

Select **Automatic Selection** and the system will acquire VIN information automatically or allow users to input the VIN manually.

4.1.3.2 Manual Input

For vehicles that do not support the Auto VIN Scan function, the MaxiSys diagnostic system allows you to enter the vehicle VIN or license numbers manually, or simply take a photo of the VIN sticker or license plate for quick vehicle identification.

- **To perform Manual Input**

1. Tap the **Diagnostics** application button from the MaxiSys Job Menu. The Vehicle Menu displays.
2. Tap the **VID Scan** button on the top toolbar.
3. Select **Manual input**.
4. Tap the input box and enter the correct VIN code or license numbers.



Figure 4-5 Sample Manual VIN Input

5. Tap **OK**. The vehicle will be identified and matched to the vehicle database and the Vehicle Diagnostics screen will display.
6. Tap the cross icon on the top right corner to exit Manual Input.

4.1.3.3 Scan VIN/License

Tap **Scan VIN/License** in the dropdown list (**Figure 4-3**), the camera will be opened. On the right side of the screen, from top to bottom, three options are available: **Scan bar code**, **Scan VIN**, and **Scan License**.

NOTE

The method of Scan License is supported in some countries and areas. Please manual input the license numbers if it is not available.

Select one of three options and position the tablet to align the VIN or license numbers within the scanning window, the result displays in the Recognition result dialog box after scanned. Tap **OK** to confirm the result, and then the vehicle information confirmation screen will display on the tablet. If all the vehicle information is correct, tap the icon in the middle of the screen to confirm the VIN of the vehicle being tested, tap **OK** to continue.

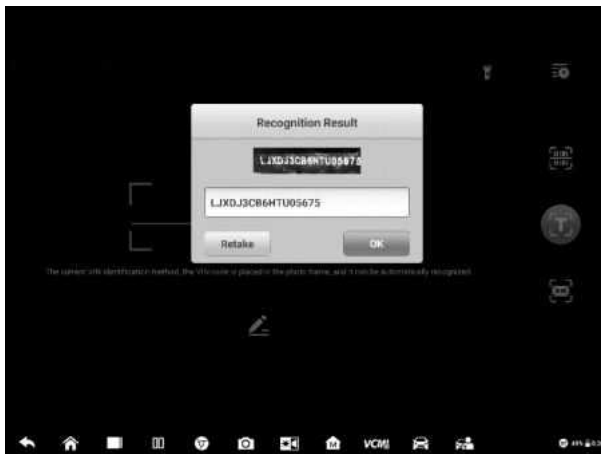

Figure 4-6 Sample Scan VIN Code 1

If the VIN/License numbers can't be scanned, please manually input the VIN/License numbers. Tap **OK** to continue. Manually input the license numbers and select a vehicle brand in the vehicle information confirmation screen. Tap the icon in the middle of the screen to confirm the VIN of the vehicle being tested, tap **OK** to continue.

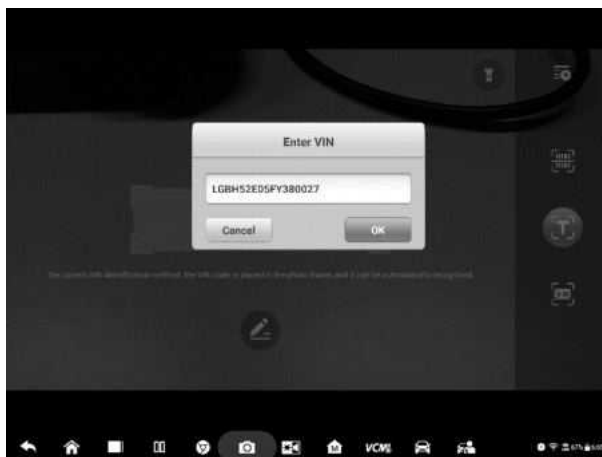

Figure 4-7 Sample Scan VIN Code 2

4.1.3.4 Manual Vehicle Selection

When the vehicle's VIN is not automatically retrievable through the vehicle's ECU, or the specific VIN is unknown, you can select the vehicle manually.

Step-by-step Vehicle Selection

This mode of vehicle selection is menu driven. Select **Manufacturer** icon on the Vehicle Menu screen to open the *Vehicle Selection* screen. Tap **Manual selection** button on the left of the screen. Select the vehicle information like the Brand, Model, Capacity, Engine type and Model year on the same screen. Tap **Reset** button to reselect the vehicle information if needed.

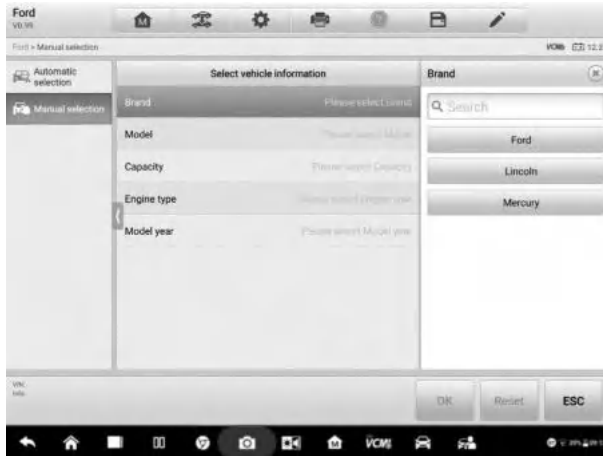

Figure 4-8 Sample Manual Vehicle Selection Screen

4.1.3.5 Alternative Vehicle Identification

Occasionally, the tablet may not be able to identify a vehicle. For these vehicles, the user may perform a generic OBDII or EOBD diagnostics. See [Generic OBD II Operations](#) on page 55 for additional information.

4.2 Diagnostics Screen Layout

This section describes how to navigate the Diagnostics interface and select test options.

4.2.1 Diagnostics Screen Layout

The Diagnostics screens typically includes six sections.







Figure 4-9 Sample Diagnostics Screen



1. Diagnostics Toolbar
2. Current Directory Path
3. Status Information Bar
4. Navigation Bar
5. Main Section
6. Functional Buttons

Diagnostics Toolbar

The Diagnostics Toolbar contains buttons that allow you to print or save the displayed data and perform other operations. The table below provides a brief description for the operations of the Diagnostics toolbar buttons:

Table 4-2 Diagnostics Toolbar Buttons

Name	Button	Description
Home		Returns to the MaxiSys Job Menu.
Vehicle Swap		Exits the diagnostic session and returns to the vehicle menu screen to select another vehicle for testing.
Settings		Opens the setting screen. See Settings on page 261.
Print		Saves and prints a copy of the displayed data. See Printing Settings on page 262.

Name	Button	Description
Help		Provides instructions or tips for operations of various diagnostic functions.
Save		<p>Opens a submenu for the 3 options to save data.</p> <ul style="list-style-type: none"> Tap Save This Page to take a screenshot image Tap Save All Data to save a PDF file (used this save option when data displays on multiple screens) <p>These files are stored in Data Manager application for later reviews. See Data Manager on page 253.</p>
Data Logging		<p>Use this function when encountering an error when testing or diagnosing a vehicle. This function will record the communication data and ECU information of the test vehicle and send it to Autel's technical staff to review and provide solution.</p> <p>Go to the Support application to follow up the processing progress, see Data Logging on page 277.</p>

➤ **To print data in Diagnostics**

1. Tap the **Diagnostics** application button on the MaxiSys Job Menu. The **Print** button on the diagnostic toolbar is available throughout the Diagnostics operations.
2. Tap **Print** and a drop-down menu displays.
 - a) **Print This Page** – prints a screenshot copy of the current screen.
 - b) **Print All Data** – prints a PDF copy of all displayed data.
3. A temporary file will be created and sent via the computer to the printer.
4. When the file is sent, a confirmation message displays.

 **NOTE**

Make sure the tablet and the printer are connected either by Wi-Fi or LAN before printing. For more instructions on printing, see [Printing Settings](#) on page 262 for details.

➤ **To submit Data Logging reports in Diagnostics**

1. Tap the **Diagnostics** application button from the MaxiSys Job Menu. The pen-shaped **Data Logging** button on the diagnostic toolbar is available throughout the whole Diagnostics operations.
2. Tap the **Data Logging** button (a pen icon) to display the error options. Select a specific error, and a submission form will display to let you fill in the report

information.

3. Tap the **Send** button in the upper right corner of the screen to submit the report form via the Internet, a confirmation message displays when sent successfully.

Current Directory Path

The Current Directory Path shows all directory names to access the current page.

Status Information Bar

The Status Information Bar at the top of the Main Section displays the following items:

1. VCMI Icon – indicates the communication status between the tablet and the VCMI device.
2. Battery Icon – indicates the battery status of the vehicle.

Navigation Bar

The Navigation Bar on the left side of the screen displays the main menu of the diagnostics functions. The main menu varies by the vehicle being tested. The common menu includes Auto Scan, Control Unit, Hot Function, Service, Vehicle Profile, Programming and more.

Main Section

The Main Section varies depending on the stage of operations which shows vehicle identification selections, the main menu, test data, messages, instructions and other diagnostic information.

Functional Buttons

The type of Functional Buttons displayed at the bottom of the screen vary by operation. Function include navigation, reporting and code clearing. The functions of these buttons will be described in the following sections when relevant.

The table below provides a brief description of the Functional Buttons' operations:

Table 4-3 Functional Buttons in Diagnostics Screen

Name	Description
Intelligent Diagnostics	Directly accesses the Intelligent Diagnostics screen to view the code-related information of ALL DTCs for the whole vehicle. For detailed operation instructions, please refers to the <i>Intelligent Diagnostics Operation</i> for details.
Report	Displays the diagnostic data in the report form.
Quick Erase	Erases all fault information after scanning.

Name	Description
Fault Scan	Scans vehicle system modules.
Pause	Pauses the scanning process.
Enter System	Enters the ECU system.
ESC	Returns to the previous screen or exit Diagnostics screen.

Select one of the system modules from the Topology or List, and tap **Enter System** to enter the specific system functions.

 **NOTE**

The Diagnostic Buttons Toolbar (located on the top of the screen) will be active throughout the diagnostic session for such tasks as printing and saving the displayed data, obtaining help information, or performing data logging.

4.2.2 Screen Messages

Messages display when additional input is needed before proceeding. There are mainly three main types of on-screen messages: Confirmation, Warning, and Error.

- **Confirmation Messages**

This type of messages usually displays as an "Information" screen, when you are about to perform an action that cannot be reversed or when an action has been initiated and your confirmation is needed to continue.

When a user-response is not required, the message displays briefly.

- **Warning Messages**

This type of messages displays when completing the selected action may result in an irreversible change or loss of data. An example of this message is the "Erase Codes" message.

- **Error Messages**

Error messages display when a systemic or procedural error has occurred. Possible errors include cable disconnection and communication interruption.

4.2.3 Making Selections

The Diagnostics application is a menu-driven program that presents a series of options one at a time. As you select from a menu, the next menu in the series displays. Each selection narrows the focus and leads to the desired test. Use your fingertip or the stylus pen to make menu selections.

4.3 Auto Scan and Control Unit

There are two options available in the Navigation Bar on the left side of the screen when accessing the Diagnosis section (Figure 4-9):

1. Auto Scan – start auto scanning for all the available systems on the vehicle
2. Control Unit – displays a selection menu of all available control units of the test vehicle

4.3.1. Auto Scan

The main section of **Auto Scan** screen displays a System List for most vehicles, a topology map at the same time for some vehicles, including Volkswagen, Audi, BMW, Ford, Land Rover, Jaguar, Chrysler, Fiat, Volvo and more.

A. Topology Tab Page

The Topology Tab Page displays a system distribution diagram of the vehicle control modules.



Figure 4-10 Sample Topology Tab Page

B. List Tab Page

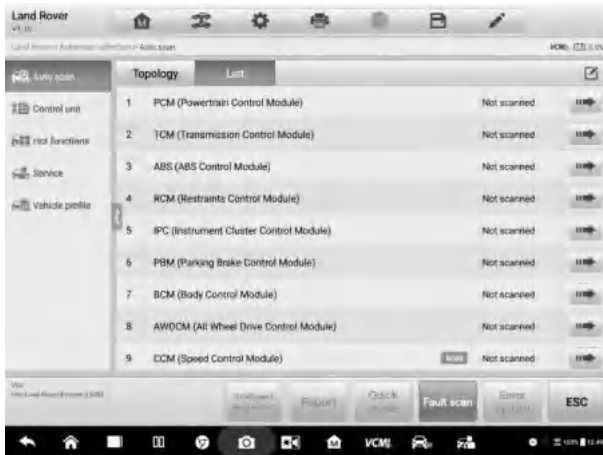

Figure 4-11 Sample List Tab Page

The **Auto Scan** function performs a comprehensive scanning of all the systems in the vehicle ECU to locate faults and retrieve DTCs. Tap **Fault Scan** to start. Systems with no faults detected will display in green; systems containing faults will display in orange.

Column 1 – displays the system numbers.

Column 2 – displays the scanned systems.

Column 3 – displays the scan results.

- ❖ **-I-**: Indicates that the scanned system may not support the code reading function, or there is a communication error between the tester and the control system.
- ❖ **-?-**: Indicates that the vehicle control system has been detected, but the tester cannot access it.
- ❖ **Fault | #**: Indicates there is/are detected fault code(s) present; "#" indicates the quantity of detected faults.
- ❖ **Pass | No Fault**: Indicates the system was scanned and no fault has been detected.
- ❖ **Not Scanned**: Indicates the system has not been scanned.
- ❖ **No Response**: Indicates the system has not received a response.

➤ **To perform Auto Scan function**

Take topology for BMW as an example:

1. Tap the **Diagnostics** application button on the MaxiSys Job Menu. Choose the corresponding vehicle information and enter the vehicle diagnostic page.

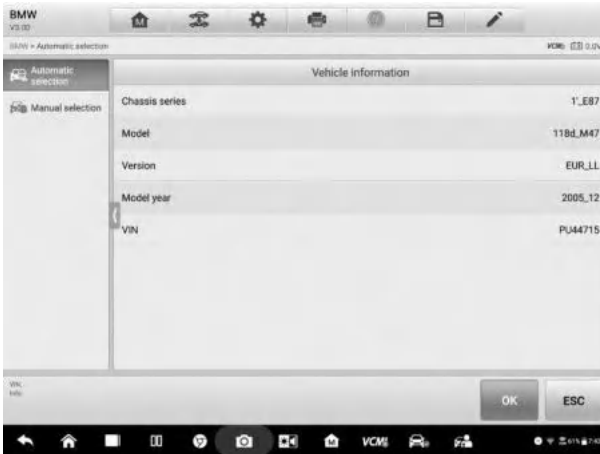

Figure 4-12 Sample Vehicle Information Selection Screen

2. The Topology tab page displays in the main section. Tap the **Fault Scan** button at the bottom of the screen to scan the vehicle system modules.



Figure 4-13 Sample Auto Scan Screen 1

3. A system scanned with no fault detected displays in green; a system scanned with faults detected will display in orange. The number of total faults will display on the upper right corner.



Figure 4-14 Sample Auto Scan Screen 2

Select System

On the Auto Scan screen, there is a **Select System icon**  on the upper right corner. Select the corresponding system(s) to scan, saving more time than scanning all systems.

4.3.2. Control Unit

The **Control Unit** allows you to manually locate a required control system for testing through a series of choices. Simply follow the menu driven procedure, and make proper selection each time; the program will guide you to the diagnostic function menu after a few choices you've made.

Tap the **Control Unit** in the Navigation Bar on the left side of the Diagnostics screen (Figure 4-9) to enter the *Function Menu* screen.

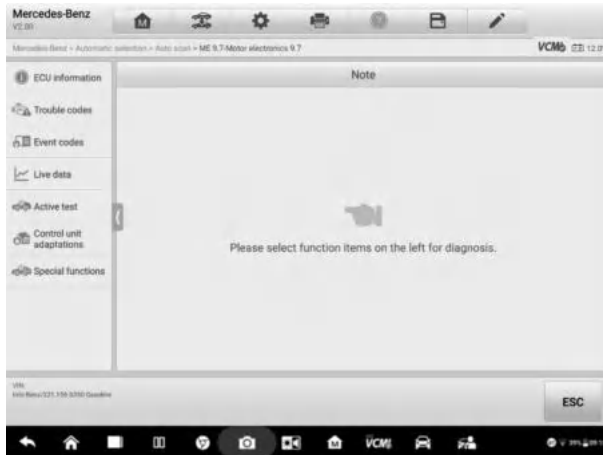

Figure 4-15 Sample Function Menu Screen

Available functions may vary by vehicle. The function menu may include:

- **ECU Information** – displays detailed ECU information. Select to display information screen.
- **Trouble Codes** – contains Read Codes and Erase Codes. The former displays detailed DTC information retrieved from the vehicle control module, the latter facilitates you to erase DTCs and other data from the ECU.
- **Live Data** – retrieves and displays live data and parameters from the vehicle's ECU.
- **Active test** – provides specific subsystem and component tests. This selection may display as *Actuators*, *Actuator Test*, or *Function Tests*. Available test vary by vehicle.
- **Special functions** – provides component adaptation or variant coding functions for custom configurations, and allows entry of adaptive values for certain components after repairs. Depending on the test vehicle, this selection may sometimes appear as *Control Unit Adaptations*, *Variant Coding*, *Configuration* or something similar.

4.4 ECU Information

This function retrieves and displays the specific information for the tested control unit, including unit type and version numbers.

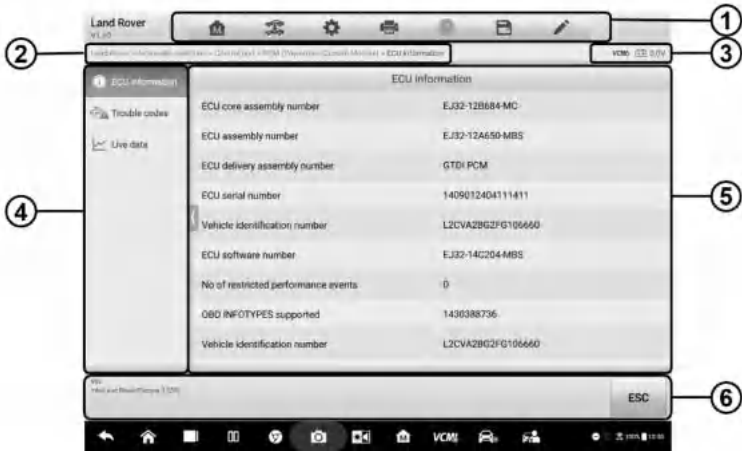

Figure 4-16 Sample ECU Information Screen

1. Diagnostics Toolbar Buttons – see [Table 4-2 Diagnostics Toolbar Buttons](#) on page 31 for detailed descriptions of the operations of each button.
2. Current Directory Path
3. Status Information Bar
4. Navigation Bar
5. Main Section – the left column displays the item names; the right column displays the specifications or descriptions.
6. Functional Button – in this case, only an **ESC** button is available; tap it to exit after viewing.

4.5 Trouble Codes

4.5.1 Read Codes

This function retrieves and displays the DTCs from the vehicle control system. The Read Codes screen varies for each vehicle being tested. For some vehicles, freeze frame data can also be retrieved for viewing. A sample Read Codes screen displays as below:



Figure 4-17 Sample Read Codes Screen

1. Diagnostics Toolbar – see [Table 4-2 Diagnostics Toolbar Buttons](#) on page 31 for details.
2. Current Directory Path
3. Status Information Bar
4. Navigation Bar
5. Main Section
 - Column 1 – displays the retrieved codes from the vehicle.
 - Column 2 – indicates the status of the retrieved codes.
 - Column 3 – detailed descriptions for the retrieved codes.
 - Column 4 – provides access to the Intelligent Diagnostics screen.
6. Functional Buttons
 - **Intelligent Diagnostics** – tap to enter the Intelligent Diagnostics screen to check related repair cases and help information.
 - **Freeze Frame** – icon displays when freeze frame data is available for viewing; Tap icon to display data screen. The Freeze Frame interface is similar to that of the Read Codes interface and share similar operations.
 - **Search** – tap to search the selected DTC for additional information on the Internet.
 - **Erase codes** – tap to erase codes from the ECU. It is recommended that DTCs are read and needed repairs are performed before erasing codes.

- **Read codes** - retrieves and displays the DTCs from the vehicle control system. The Read Codes screen varies for each vehicle being tested.
- **ESC** – tap it to return to the previous screen or exit the function.

4.5.2 Erase Codes

After reading the retrieved codes from the vehicle and certain repairs have been made, you can erase the codes from the vehicle using this function. Before performing this function, make sure the vehicle's ignition key is in the ON (RUN) position with the engine off.

➤ To erase codes

1. Tap **Erase Codes** in the Function Menu.
2. A warning message displays to inform you of data loss when this function is applied.
 - a) Tap **Yes** to continue. A confirming screen displays when the operation is successfully done.
 - b) Tap **No** to exit.
3. Tap **ESC** on the confirming screen to exit Erase Codes.
4. Check the Read Codes function again to ensure the operation is successful.

4.6 Live Data

When this function is selected, the screen displays the data list for the selected module. The parameters display in the order that they are transmitted by the ECU, so expect variation among vehicles.

Gesture scrolling allows you to quickly move through the data list. Touch the screen and drag your finger up or down to reposition the parameters being displayed if the data occupies more than one screen. The figure below displays a typical Live Data screen:



Figure 4-18 Sample Live Data Screen

1. **Diagnostics Toolbar Buttons** – see [Table 4-2 Diagnostics Toolbar Buttons](#) on page 31 for detailed descriptions of the operations for each button.
2. **Current Directory Path**
3. **Status Information Bar**
4. **Navigation Bar**
5. **Main Section**
 - Name Column – this column displays the parameter names.
 - a) Check Box – tap the check box to the left of a parameter name to select the item. Tap the check box again to deselect it.
 - b) Drop-down Button – tap the drop-down button on the right side of the parameter name to open a submenu that provides optional modes in which to display the data.
 - Value Column – displays the values of the parameter items.
 - Unit Column – displays the unit for the parameter values.
 - To change the Unit mode, tap the **Setting** button in the top toolbar and select a required mode. See [Unit](#) on page 261.

Display Mode

There are four types of display modes available for data viewing, allowing you to view various types of parameters in the mode best suited to represent the data.

Tap the drop-down button on the right side of the parameter name to open a submenu. A total of 7 buttons will be displayed: The 4 buttons to the left represent different data display modes, plus one **Information** button, active when additional information is available, and one **Unit Change** button, for switching the unit of displayed data, and one **Trigger** button, tap to open the "trigger setting" window.

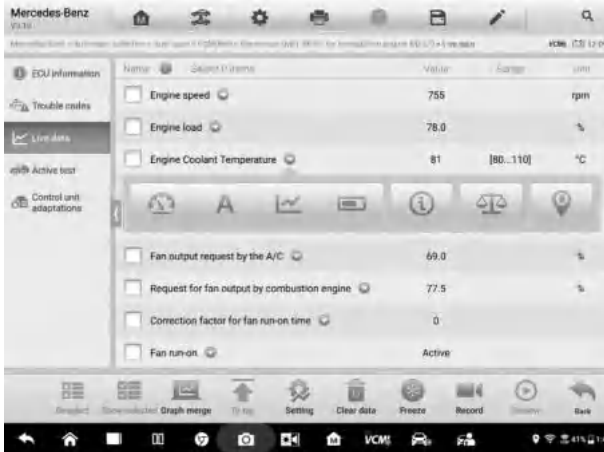

Figure 4-19 Sample Display Mode Screen

Each parameter item displays the selected mode independently.

- ✧ **Analog Gauge Mode** – displays the parameters in gauge charts.
- ✧ **Text Mode** – the default mode that displays the parameters as a text list.

NOTE

Status parameters, such as a switch reading like ON, OFF, ACTIVE, and ABORT can only be displayed in Text Mode. Value parameters, such as a sensor reading, can be displayed in both text and graph modes.

- ✧ **Waveform Graph Mode** – displays the parameters in waveform graphs.

In this mode, five control buttons will display on the right side of the parameter item, allowing you to manipulate the display status.



Figure 4-20 Sample Waveform Graph Mode Screen

- 1) **Settings Button (SetY)** – sets the minimum and maximum value of the Y axis.
- 2) **Scale Button** – changes the scale values.

There are two scale buttons, displayed above the waveform graph to the right side, which can be used to change the scale values of the X axis and Y axis of the graph. There are four scales available for the X axis: x1, x2, x4 and x8. There are three scales available for the Y axis: x1, x2, and x4.

- 3) **Edit Button** – edit the waveform color and the line thickness.
- 4) **Zoom-in Button** – tap once to display the selected data graph in full screen.
- 5) **Exit Button** – tap to exit the waveform graph mode.

Full Screen Display – this option is only available in the waveform graph mode, and mostly used in Graph Merge status for data comparison. There are four control buttons available on the top right side of the screen under this mode.

- Scale Button – tap to change the scale values below the waveform graph. There are four scales available for the X axis: x1, x2, x4 and x8. There are three scales available for the Y axis: x1, x2, and x4.
- Edit Button – tap to open an edit window, in which you can set the waveform color and the line thickness displayed for the selected parameter item.
- Zoom-out Button – tap to exit full screen display.
- Exit Button – tap to exit the waveform graph mode.

➤ **To edit the waveform color and line thickness in a data graph**

1. Select parameter items to display in Waveform Graph mode.
2. Tap the **Edit Button**, and an edit window displays.



Figure 4-21 Sample Waveform Edit Screen

3. The parameter item is selected automatically in the left column.
4. Select a color from the second column.
5. Select a line thickness from the right column.
6. Tap **Done** to save the setting and exit, or tap **Cancel** to exit without saving.

NOTE

In full screen display, please edit the waveform color and line thickness by tapping the Edit Button on the top right side of the screen.

Trigger Setting

On the trigger setting screen, you can set a standard range by filling in a Minimum value and a Maximum value. When exceeding this range, the trigger function will be executed and the device will automatically record and save the generated data. You can check the saved live data by tapping the "Review" button at the bottom of the screen.

Tap the drop-down button on the right side of the parameter name to open a submenu. The **Trigger** button is the last one in the submenu. Tap to display the trigger setting window.



Figure 4-22 Sample Trigger Setting Screen

Two buttons and two input boxes are available in the Trigger Setting window.

- a) Trigger On – switches the trigger on and off. The trigger is ON by default.
- b) Buzzer Alarm – switches the alarm on and off. The alarm function makes a beep sound as an alert when the data reading reaches the preset minimum or maximum point. The buzzer alarm will only sound at the first trigger.
- c) MIN – tap this input box to display a virtual keyboard to enter the required lower limit value.
- d) MAX – tap this input box to display a virtual keyboard to enter the required upper limit value.

➤ **To set a trigger**

1. Tap the drop-down button on the right side of the parameter name to open a submenu.
2. Tap the **Trigger** button on the right side of the submenu to open the trigger settings window.
3. Tap the **MIN** button on the right side, and enter the required minimum value.
4. Tap the **MAX** button on the right side, and enter the required maximum value.
5. Tap **OK** to save the setting and return to the Live Data screen; or tap **Cancel** to exit without saving.

When the trigger is successfully set, a trigger mark displays in front of the parameter name. The mark is gray when it is not triggered, and displays orange when triggered. Moreover, two horizontal lines display on each of the data graphs (when Waveform Graph Mode is applied) to indicate the alarm point. The limit lines are shown in different

colors to differentiate them from the parameter waveforms.

- ✧ **Digital Gauge Mode** – displays the parameters in the form of a digital gauge graph.

6. Functional Buttons

The operations of the available functional buttons on the Live Data screen are described below:

- ✧ **Cancel All** - Tap this button to cancel all selected parameter items. Up to 50 parameters can be selected at one time.
- ✧ **Show Selected/Show All** – tap this button to switch between the two options; one displays the selected parameter items, the other displays all the available items.
- ✧ **Graph Merge** – tap this button to merge selected data graphs (for Waveform Graph Mode only). This function is very useful when comparing different parameters.



NOTE

This mode supports Graph Merge of 2 to 5 parameters that can be represented digitally. Non-digital parameters are not supported.

➤ To merge selected data graphs

- 1) Select parameter items to be merged.
 - 2) Tap the **Graph Merge** button at the bottom of the Live Data screen.
 - a) This mode only supports parameters that can be represented digitally. If non-digital parameters are selected, a message will display advising the user that the selected parameters are not supported in this mode and to select 2 to 5 digital parameters. Tap **Got It** button to return to the previous screen and select supported parameters.
 - b) If parameters are selected that are not supported in this mode, a message will display advising the user to selected only parameters that are supported. A message will also display if more than 5 parameters have been selected. Please select 2 to 5 of the supported parameters and tap **OK** button to merge.
 - 3) Tap **Cancel Merging** button at the bottom of the Live Data screen to cancel merge.
- ✧ **To Top** – moves a selected data item to the top of the list.
 - ✧ **Setting** – tap this button to set recording duration. Five options are available: 5 seconds, 15 seconds, 30 seconds, 60 seconds and 90 seconds.

➤ To set live data record duration

1. Tap **Setting** button at the bottom of the Live Data screen.

2. Tap the > button to the right of **Recording time after trigger** bar and select a time length.
3. Tap **OK** to save the setting and return to the Live Data Setting screen; or tap the X button at the upper right corner to exit without saving.
4. Tap **Done** at the upper right corner of the Live Data Setting screen to confirm and save the setting, and return to the Live Data screen; or tap **Cancel** to exit without saving.

✧ **Clear Data** – tap this button to clear all cached live data.

✧ **Freeze** – displays the retrieved data in freeze mode.

- Previous Frame – moves to the previous frame of frozen data.
- Next Frame – moves to the next frame of frozen data.
- Play/Pause – tap to play/pause the frozen data.
- Resume – tap to exit the freeze data mode and return to normal data display.

✧ **Record** – starts recording the live data of the selected data items. Tap the **Record** button at the bottom of the Live Data screen. A message will display prompting user to select parameters to record. Tap **Got It** button to confirm. Scroll down and select data to record. Tap the **Record** button to start recording. Tap **Resume** button to stop recording. The recorded live data can be viewed in the **Review** section at the bottom of the Live Data screen. The recorded data can also be reviewed in the Data Manager application.

- Resume – Tap this button to stop data recording and to return to normal data display.
- Flag – this button displays when the Record function is applied. Tap this button to set flags to note points of interest when recording data. Notes can be added during playback in Review or *Data Manager*. Select the preset flag to open a popup window and display virtual keyboard to input notes.

✧ **Review** – review the recorded data. Tap **Review** button to display a recording list, and select one item to review.

NOTE

Only the data recorded during the current operation can be reviewed on the Live Data screen. All the historical recorded data can be reviewed in "Review Data" in the Data Manager application.

- Previous Frame – switches to the previous frame of recorded data.
- Next Frame – switches to the next frame of recorded data.
- Play/Pause – tap to play/pause the recorded data.
- Show Selected – display the selected parameter items.
- Graph Merge - merge selected data graphs.

- Back – exit the review, and return to the Live Data screen.
- ✧ **Back** – returns to the previous screen or exits the function.

4.7 Active Test

The Active Test function is used to access vehicle-specific subsystem and component tests. Available tests vary by vehicle.

During an active test, the tablet sends commands to the ECU to activate the actuators. This test determines the integrity of the system or part by reading ECU data, or by monitoring the operation of the actuators. Such tests may include switching a solenoid, relay, or switch, between two operating states.

Selecting Active Test displays a menu of test options. Available tests vary by vehicle. Select test from menu options. Follow the instructions displayed on the screen to complete test. Procedures and instructions vary by vehicle.

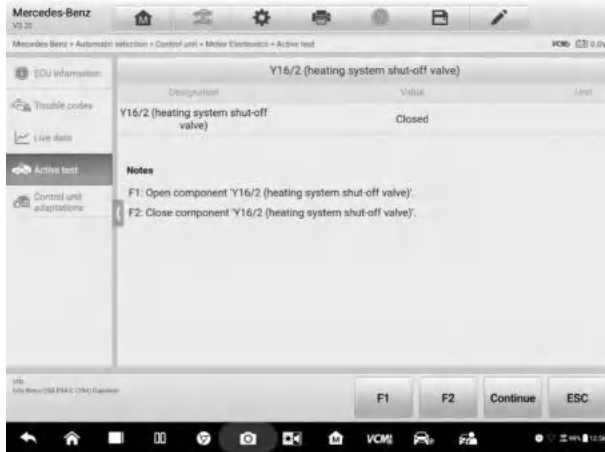

Figure 4-23 Sample Active Test Screen

The functional buttons in the lower right corner of the Active Test screen manipulate the test signals. The operational instructions are displayed in the main section of the test screen. Follow the on-screen instructions and make appropriate selections to complete the tests.

Tap the **ESC** functional button to exit the test when finished.

4.8 Special Functions

These functions perform various component adaptations, including the recalibration or configuration of certain components after repairs or replacements have been completed.

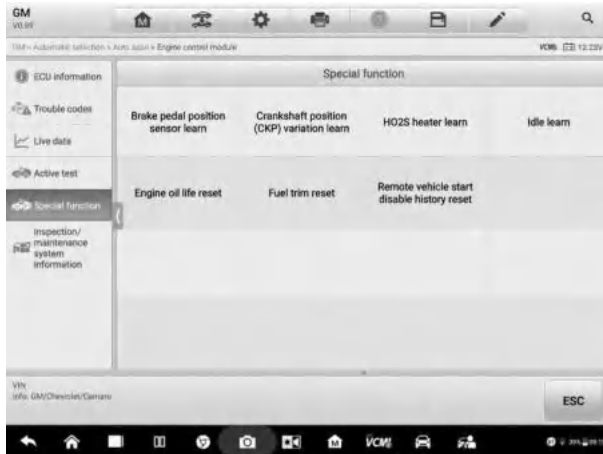

Figure 4-24 Sample Special Function Screen 1

Select function to display detailed Function information and execution screen.

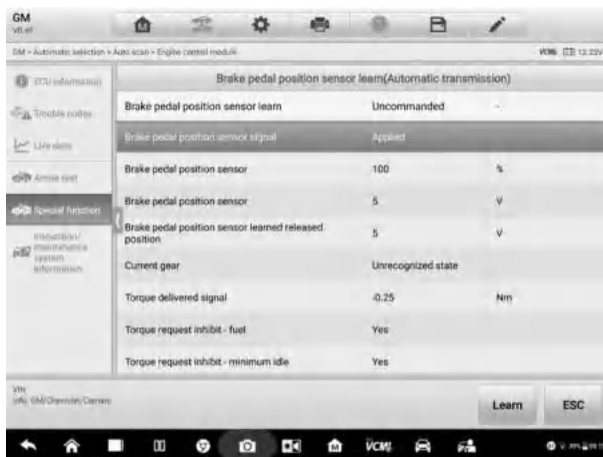

Figure 4-25 Sample Special Function Screen 2

List Tab Page:

- Column 1 – displays the description of the function being performed or displays live data corresponding to the special function
- Column 2 – displays the execution status such as Completed, or Activated or may display live data values that correspond to the special function.
- Column 3 – displays the measurement units of the live data.

Tap the Functional buttons to perform the selected function or exit the function.

4.9 Programming and Coding

Since the introduction of OBD II and leading up to modern Hybrids and EVs, hardware and software technologies in cars have been advancing at an exponential rate. Updating software may be the only way to fix the following issues:

- Drivability
- Fuel Efficiency
- Power Loss
- Fault Codes
- Durability of Mechanical Parts

The Programming and Coding function is used to re-flash the vehicle control modules, which allows you to update the computer software of the vehicle to the latest version, as well as to reprogram adaptive data of certain components after making repairs or replacements.

NOTE

The programming function applies only when the vehicle is connected with a VCMI device, which serves as a PassThru interface to establish communication with and transfer data to the vehicle's ECU.

Available programming or coding operations vary by test vehicle. Only the available operations display in the tablet menu.

There are two general types of programming operations:

- A. Coding – also known as *Teach-in Program*, or *Component Adaptation*, is used to reprogram adaptive data for vehicle control modules after repairs or replacements of vehicle parts.
- B. Reprogramming – downloads the latest version of software from the online server database through Internet access (this procedure is done automatically when the tablet is connected to the Internet, so there is no need to check for software updates yourself), and reprograms the newest version into the vehicle's ECU.

NOTE

Ensure that the tablet is connected to a stable internet access before applying the ECU programming function, so that the tablet is able to obtain access to the vehicle manufacturer's server for update service.

Selecting the Programming or Coding function opens a menu of operation options that varies by vehicle make and model. Selecting a menu option either displays a programming interface or opens another menu of additional choices. Follow all screen

instructions while performing the programming or coding operations. How and what information is presented on the screen vary by the type of operation being performed.

4.9.1 Coding

The main section of the Coding screen displays a list of vehicle components and the coding information that mainly consists of two parts:

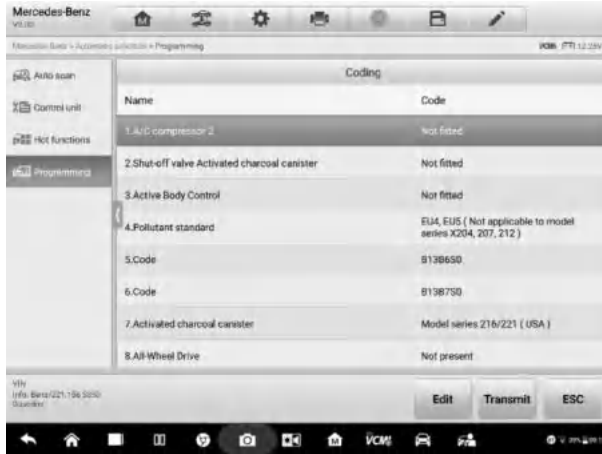

Figure 4-26 Sample Coding Screen

1. All available systems for coding are displayed on the left side, and the coding data or value on the right side.
2. The bottom of the main section displays the functional buttons that enable you to manipulate the operation.

Check the vehicle condition and the coding information carefully. Use the functional button to edit Codes for the corresponding components. Tap **Send** when you finish editing all items. When the operation is completed, an execution status message such as Completed, Finished or Successful, may display.

Tap the **ESC** button to exit the function.

4.9.2 Reprogramming

Before reprogramming begins

- It is mandatory that Ultra tablet is connected to stable Wi-Fi network.
- Tablet must be connected to VCMI by USB.
- Tablet battery must be fully charged during module programming. Connect tablet to

charger if needed.

- Attach battery maintainer to vehicle battery to ensure a steady voltage is maintained throughout programming. Voltage requirements differ by vehicle manufacturer. Consult vehicle manufacturer recommendations prior to programming a module.
- Do not quit the application during a module reprogramming as the process may fail and may also result in permanent damage to the module.

Typical reprogramming operations require you to input and validate VIN number first. Tap the input box and enter the correct number. The programming interface then displays.

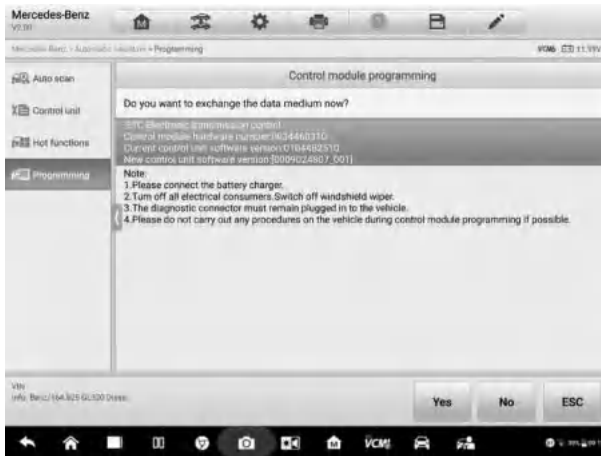

Figure 4-27 Sample Reprogramming Operation Screen

The main section of the reprogramming interface offers information of the hardware, the current software version and the newest software versions to be programmed into the control units.

A series of on-screen operational instructions will display to guide you through the programming procedure.

Carefully read the on-screen information and follow the instruction to execute the programming procedure.

4.9.3 Re-flash Errors

! IMPORATANT

When reprogramming onboard, always make sure the vehicle battery is fully charged and in good working condition. During reprogramming, the operation may fail if voltage falls below the proper operation voltage. Sometimes a failed operation can be recovered, but the failed reprogramming can also ruin the control module. We recommend connecting an external battery maintainer to the vehicle to ensure a steady voltage is

maintained throughout programming. The required voltage differs by vehicle manufacturer. Consult vehicle manufacturer for correct voltage to be maintained.

Occasionally a flash update procedure may not complete properly. Common causes of flash errors include poor cable connections between the tablet, VCMI, and vehicle, the vehicle ignition being switched off before the flash procedure is complete, or low vehicle battery voltage.

If the process quits, recheck all the cable connections to assure good communications and initialize the flash procedure. The programming procedure will automatically repeat if the previous operation does not succeed.

4.10 Generic OBD II Operations

The OBD II/EODB vehicle diagnosis option offers a quick way to check for DTCs, isolate the cause of an illuminated malfunction indicator lamp (MIL), check monitor status prior to emissions certification testing, verify repairs, and perform other emissions-related services. The OBDII direct access option is also used for testing OBD II/EODB-compliant vehicles that are not included in the Diagnostics database. Diagnostics toolbar buttons at the top of the screen are available for specific vehicle diagnostics. See [Table 4-2 Diagnostics Toolbar Buttons](#) on page 31 for details.

4.10.1 General Procedure

➤ **To access the OBD II/EODB diagnostics functions**

1. Tap the **Diagnostics** application button in the MaxiSys Job Menu. The Vehicle Menu displays.
2. Tap the **EODB** button. There are two options to establish communication with the vehicle.
 - Auto Scan – select it to establish communication using each protocol in order to determine which one the vehicle is using.
 - Protocol – select it to open a submenu of various protocols. A communication protocol is a standardized way of data communication between an ECM and a diagnostic tool. Global OBD may use several different communication protocols.
3. Select a specific protocol if the **Protocol** option is selected. Wait for the OBD II Diagnostic Menu to appear.

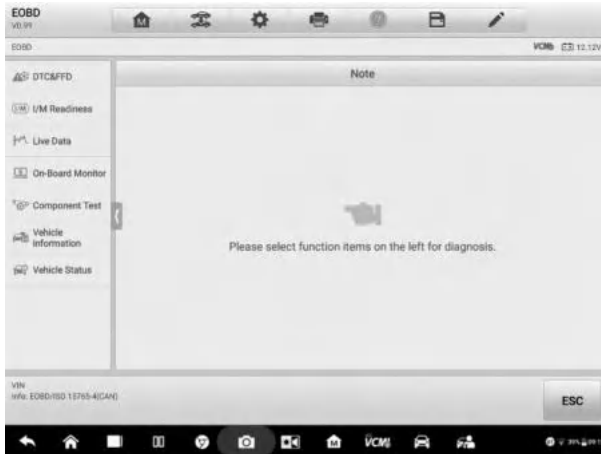

Figure 4-28 Sample OBD II Diagnostic Menu

4. Select a function option to continue.
 - DTC & FFD
 - I/M Readiness
 - Live Data
 - O2 Sensor Monitor
 - On-Board Monitor
 - Component Test
 - Vehicle Information
 - Vehicle Status

NOTE

Support functions may vary by vehicle.

4.10.2 Function Descriptions

This section describes the various functions of each diagnostic option:

4.10.2.1 DTC & FFD

When this function is selected, the screen displays a list of Stored Codes and Pending Codes. When the Freeze Frame data of certain DTCs are available for viewing, a snowflake button will display on the right side of the DTC item. The Erase Codes and

Read codes functions can be applied by tapping the functional buttons at the bottom of the screen.

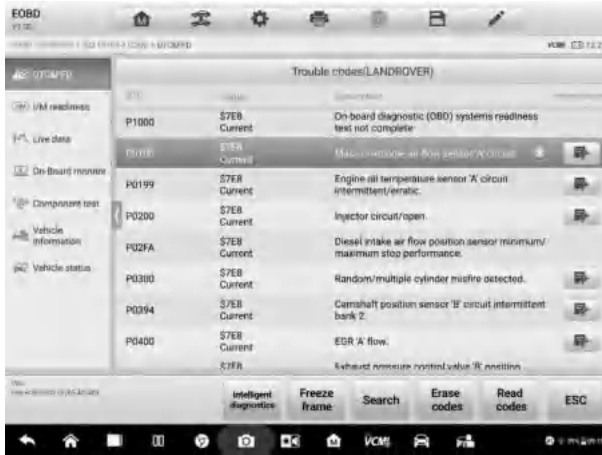

Figure 4-29 Sample DTC & FFD Screen

- **Current Codes**

Current codes are emission-related DTCs from the ECM of the vehicle. OBD II/EOBD Codes have a priority according to their emission severity, with higher-priority codes overwriting lower-priority ones. The priority of the code determines the illumination of the Malfunction Indicator Light (MIL) and the codes erase procedure. Manufacturers rank codes differently, so DTCs may vary by vehicle.

- **Pending Codes**

These are codes whose storing conditions have been met during the last drive cycle, but need to be met on two or more consecutive drive cycles before the DTC stored. The purpose of displaying pending codes is to assist the service technician after a vehicle repair when diagnostic information is cleared, by reporting test results after a single driving cycle.

- a) If a test fails during the driving cycle, the DTC associated is reported. If the pending fault does not occur again within 40 to 80 warm-up cycles, the fault is automatically cleared from memory.
- b) Test results reported do not necessarily indicate a faulty component or system. If test results indicate another failure after additional driving, a DTC is stored to indicate a faulty component or system.

- **Freeze Frame**

In most cases the stored frame is the last DTC reported. Certain DTCs, those that have a greater impact on vehicle emission, have a higher priority. In these cases,

DTC of the highest priority is the one for which the freeze frame records are retained. Freeze frame data includes a "snapshot" of critical parameter values at the time the DTC is stored.

- **Erase Codes**

This option is used to clear all emission-related diagnostic data including DTCs, freeze frame data and specific manufacturer-enhanced data from the vehicle ECM. This option resets the I/M Readiness Monitor Status for all vehicle monitors to Not Ready or Not Complete status.

A confirmation screen displays when the clear codes option is selected to prevent accidental loss of data. Select **Yes** on the confirmation screen to continue, or **No** to exit.

4.10.2.2 I/M Readiness

This function is used to check the readiness of the monitoring system. It is an excellent function to use prior to having a vehicle inspected for state emissions compliance. Selecting I/M Readiness opens a submenu with two choices:

- Since DTCs Cleared – displays the status of monitors since the last time the DTCs are erased.
- This Driving Cycle – displays the status of monitors since the beginning of the current drive cycle.

4.10.2.3 Live Data

This function enables the display of real-time PID data from the ECU. Displayed data includes analog and digital input and output, and system status information broadcast in the vehicle data stream.

Live data can be displayed in various modes, see [Live Data](#) on page 42 for detailed information.

4.10.2.4 O2 Sensor Monitor

This function allows retrieval and review of recent O2 sensor monitor test results stored on the vehicle's on-board computer.

The O2 Sensor Monitor test function is not supported by vehicles that communicate using a controller area network (CAN). For O2 Sensor Monitor tests results of CAN-equipped vehicles, refer to [On-Board Monitor](#).

4.10.2.5 On-Board Monitor

This function allows you to view the results of On-Board Monitor tests. The tests are useful after the service when a vehicle's control module memory is already erased.

4.10.2.6 *Component Test*

This function enables dual-directional control of the ECM so that the diagnostic tool can transmit control commands to operate the vehicle systems. This function is useful in determining how well the ECM responds to a command.

4.10.2.7 *Vehicle Information*

This function enables the display of the vehicle identification number (VIN), calibration identification number, calibration verification number (CVN), and other information of the test vehicle.

4.10.2.8 *Vehicle Status*

This function checks the current condition of the vehicle, such as the communication protocols of OBD II modules, number of fault codes, and status of the Malfunction Indicator Light (MIL).

4.11 Diagnostic Report

4.11.1 Pre-Scan and Post-Scan

➤ To perform the pre-scan and post-scan functions

1. Auto SCAN the Vehicle - the Auto VID function can automatically identify the vehicle and its equipped systems. All available modules in all systems will be scanned automatically. Then DTCs and code details will be listed.
2. Print Pre-SCAN Report - vehicle images can be taken with tablet and attached to SCAN report. The report file can be generated and submitted. The report can be customized with shop and vehicle information.
3. Repair Vehicle - creates efficient repair plan from the start.
4. Auto SCAN Repaired Vehicle - ensures no new faults were created during repair and no DTCs are present at completion.
5. Print Post-SCAN Report - proves all DTCs on Pre-SCAN report are fixed.

4.11.2 Diagnostic Report PDF

The diagnostic report can be reviewed, saved, and printed in multiple applications of the Ultra platform.

a) Via the **History** function:

- Enter the Diagnosis main page, and tap **History** in the Top Toolbar.

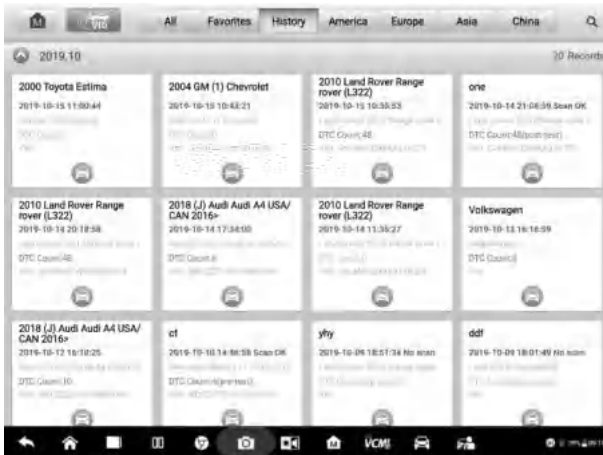

Figure 4-30 Sample History Screen

- Select a history record, and tap the **...** button in the upper right corner to view the PDF document, print, email or delete the historical test.



Figure 4-31 Sample Historical Test Screen

b) Via the **Auto Scan** function:

- Enter the Auto Scan page and tap **Fault Scan** in the Functional Button Bar at the bottom of the screen.

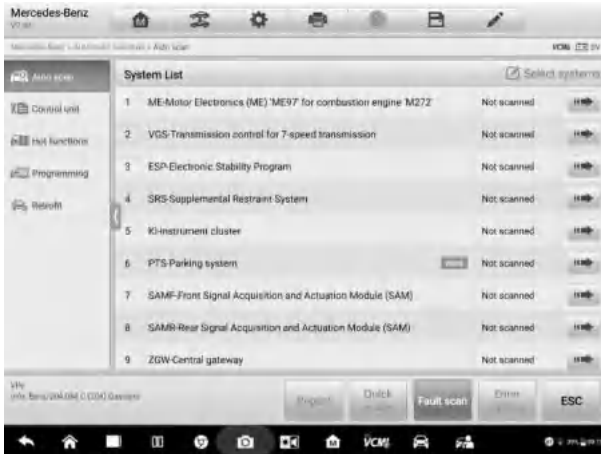

Figure 4-32 Sample Auto Scan Screen 1

- When the system scan is completed, tap **Report** in the Functional Button Bar at the bottom of the screen.

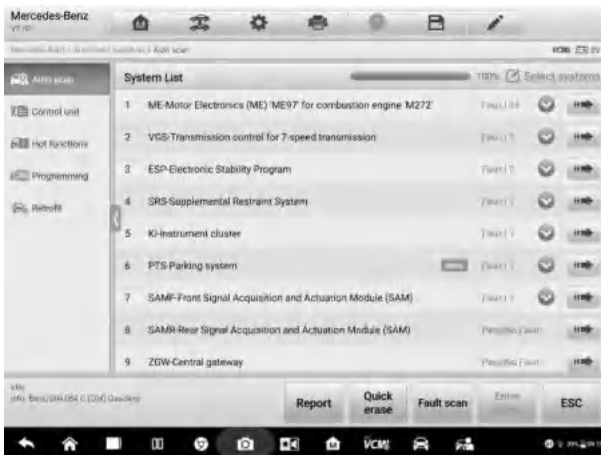

Figure 4-33 Sample Auto Scan Screen 2

- Tap the  button in the Diagnostics Toolbar, and select **Save all data** to save the PDF document or select **Save this page** to save the screenshot of the current page.



Figure 4-34 Sample Auto Scan Screen 3

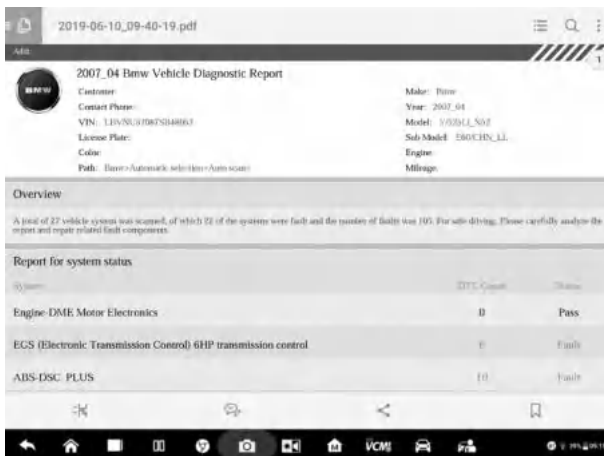



Figure 4-35 Sample PDF Document Screen

- c) Via the functions on the Navigation Bar:
- The diagnostic report can also be viewed from such diagnostics functions screen including Auto Scan, Read Codes, Live Data, and Active Test. Tap the  button in the Diagnostics Toolbar, and select **Save all data** to save the PDF document or select **Save this page** to save the screen shot of the current page.

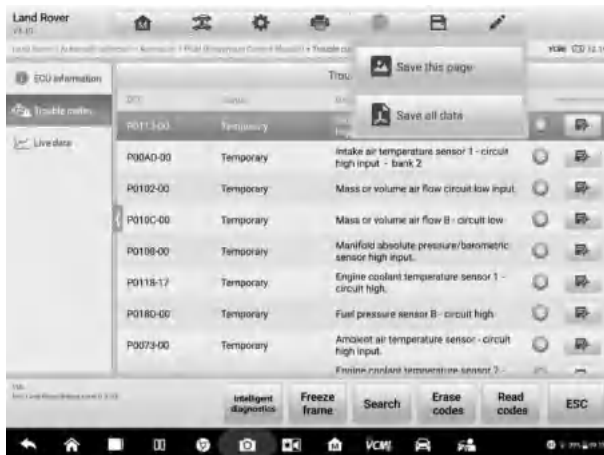

Figure 4-36 Sample Read Codes Screen

4.12 Exit Diagnostics

The Diagnostics application operates while communication with the vehicle is still active. It is important to properly exit from the diagnostics operation interface to stop all communications with the vehicle before closing the Diagnostics application.

NOTE

Damage to the vehicle electronic control module (ECM) may occur if communication is disrupted. Ensure all forms of communication link such as data cable, USB cable, and wireless or wired network, are properly connected throughout the test. Exit all interfaces before disconnecting the test cable and power supply.

➤ To exit the Diagnostics application

1. On an active diagnostic screen, tap the **Back** or **ESC** functional button to exit a diagnostic session; Or
2. Tap the **Vehicle Swap** button in the diagnostics toolbar to return to the Vehicle Menu screen.
3. On the vehicle menu screen, tap the **Home** button in the top toolbar; or tap the **Back** button on the navigation bar at the bottom of the screen. Or
4. Tap the **Home** button on the diagnostics toolbar to exit the application directly and return to the MaxiSys Job Menu.

Now, the Diagnostics application is no longer communicating with the vehicle and it is safe to open other MaxiSys applications, or exit the MaxiSys Diagnostic System and return to the Android System's Home screen.

5 Intelligent Diagnostics

Intelligent Diagnostics is a specific fault code analysis function, with which you can access the most comprehensive and the latest code-specific data, DTC analysis, repair assist, repair tips, and relevant repair cases. It has been drawn from real world shop repair orders and records and with input from experienced industry professionals.

Intelligent Diagnostics adopts the scientific data cloud computing technology to match the specific fault code with the exact vehicle model. And the data has been thoroughly verified by automotive maintenance professionals.

The following are main parts of the code data contained in Intelligent Diagnostics:

1. Vehicle System and Detected DTC(s)
2. Technical Service Bulletin (OEM Information)
3. DTC Analysis
4. Repair Assist
5. Repair Tips
6. Component Measurement
7. Relevant Cases

NOTE

Before performing the Intelligent Diagnostics function, please ensure the network is connected successfully.

5.1 Accessing Intelligent Diagnostics Function

5.1.1 Auto Scan

Before starting Intelligent Diagnostics, please ensure that vehicle communication has been established. Connect the MaxiSys Ultra Diagnostic tablet to the test vehicle through the VCMI device. For detailed directions to establish vehicle communication with the MaxiSys tablet, see [Establish Vehicle Communication](#).

Once communication has been established, enter the **Diagnostics** application and select the vehicle model. From the **Diagnostic menu**, select **Auto scan**. The **System list** screen will display. For detailed instructions on using the Auto scan function, see [Auto Scan](#).

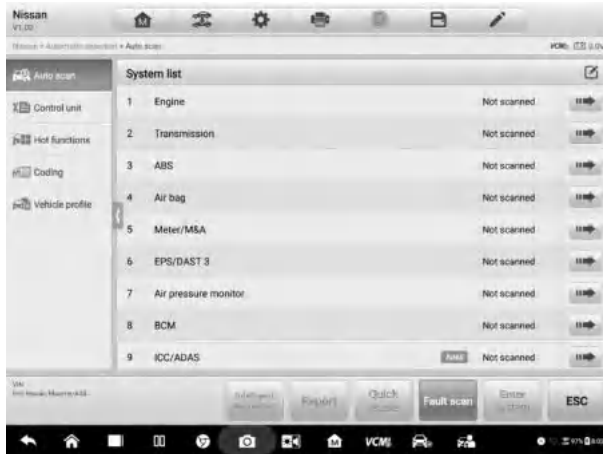

Figure 5-1 Sample System List Screen

For a number of vehicle brands, including Volkswagen, Audi, BMW, Ford, Land Rover, Jaguar, Chrysler, Fiat, Volvo and more, a topology map is available to display the relationship between vehicle systems.



Figure 5-2 Sample Topology Display Screen

Select the **List** tab to display the vehicle systems as a list.

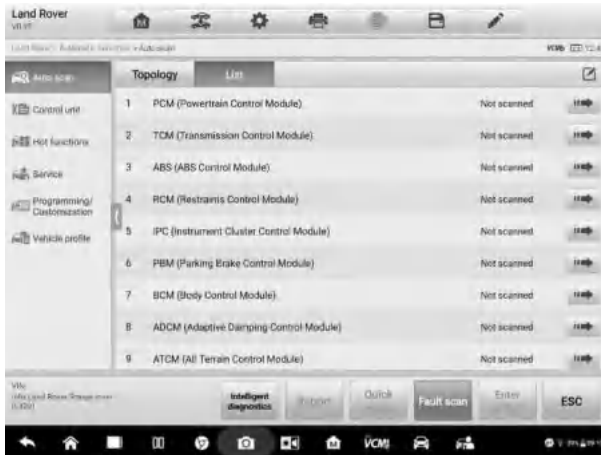

Figure 5-3 Sample List Screen

5.1.2 Scan System Faults

Once the vehicle system listing or Topology mapping has been completed, tap the **Fault scan** button at the bottom of the **System list**, **Topology** or **List** screen to find the faults in the vehicle systems.

- 1) On the **System list** screen, tap the **Fault scan** button at the bottom. After scanning, a system with identified faults will display in red, with the number of faults displayed on the right. The number of total faults will display on the top.

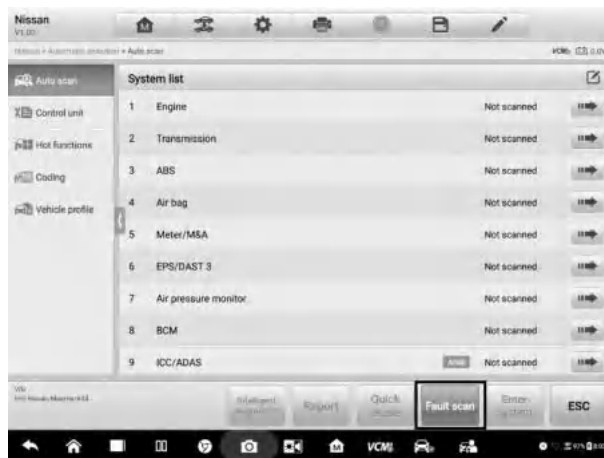

Figure 5-4 Sample Fault Scan on System List Screen 1

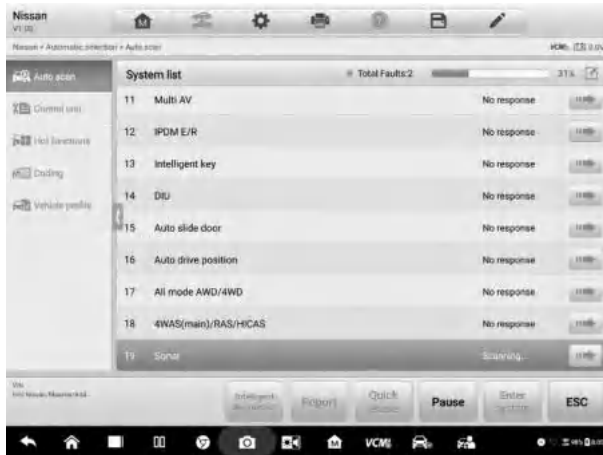

Figure 5-5 Sample Fault Scan on System List Screen 2

- 2) On the **Topology** screen, a system with identified faults will display in orange, with the number of faults displayed in the upper right corner of the system icon. The number of total faults will display on the top.



Figure 5-6 Sample Fault Scan on Topology Screen

- 3) On the **List** screen, a system with identified faults will also display in red, with the number of faults on the right. The number of total faults will display on the top.

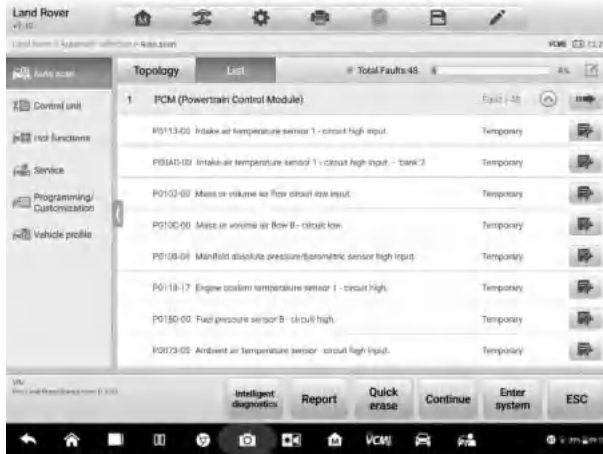



Figure 5-7 Sample Fault Scan on List Screen

After scanning system faults, there are two methods to access the Intelligent Diagnostics screen:

- Access via the **Intelligent Diagnostics button**  to view code-related information of all DTCs for the whole vehicle.
- Access via the **Intelligent Diagnostics icon**  to view code-related information of a specific DTC.

5.1.3 Access via Intelligent Diagnostics Button

After all the faults of the vehicle systems are scanned, tap the **Intelligent diagnostics button** on the lower corner of the screen to directly enter the Intelligent Diagnostics screen.

Entering the Intelligent Diagnostics screen, you can find the TSB, DTC analysis, repair assist and repair tips information of **All DTCs** for all the systems that have been scanned. For detailed operation instructions, please refer to the [Intelligent Diagnostics Operation](#) for details.



Figure 5-8 Sample Intelligent Diagnostics Button Screen

5.1.4 Access via Intelligent Diagnostics Icon

You can also use the **Intelligent Diagnostics icon** to enter the Intelligent Diagnostics function to get detailed fault repair instructions of a **specific DTC**.

The details of the detected fault(s), including the fault code, fault description and status, will be displayed right under the system name or module. If the Intelligent Diagnostics function is available for this vehicle, the **Intelligent Diagnostics icon** will display on the right.

On the **List** screen, tap the **Intelligent Diagnostics icon** on the right side to enter the Intelligent Diagnostics screen directly.

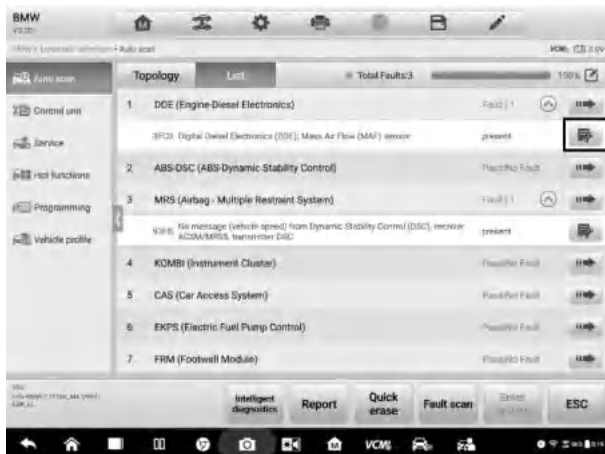



Figure 5-9 Sample Intelligent Diagnostics Icon Screen 1

Or on the **Topology** screen, once the system scan is complete, tap a system icon (displays in orange if faults are detected) to display complete system name with the Intelligent Diagnostics icon shown below. Tap the **Intelligent Diagnostics icon** to enter the Intelligent Diagnostics screen directly.



Figure 5-10 Sample Intelligent Diagnostics Icon Screen 2

When entering a specific system by tapping the arrow-shaped icon , you can also access the Intelligent Diagnostic screen if the Intelligent Diagnostics function is available for this vehicle.

➤ **To access the Intelligent Diagnostics screen after entering a specific system**

1. On the System list, Topology or List screen, tap the arrow icon  to enter a system, the Function menu will display. Available functions vary by vehicle.

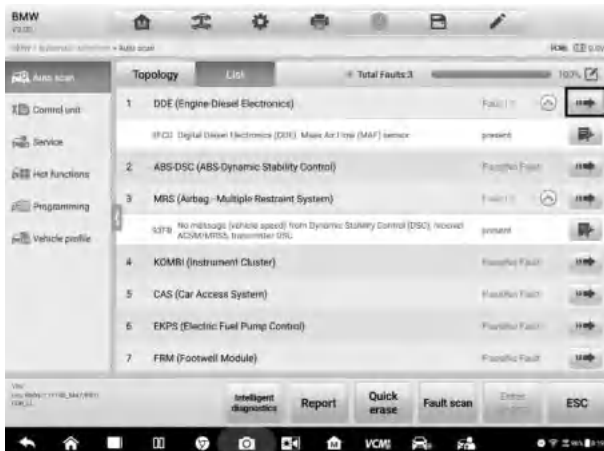

Figure 5-11 Sample Entering System Icon Screen (List)



Figure 5-12 Sample Entering System Icon Screen (Topology)

2. Select **Trouble codes** from the Function menu on the left side and the trouble codes screen will display.

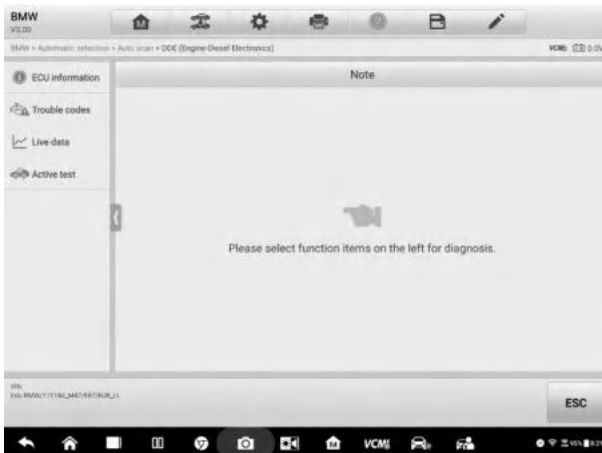



Figure 5-13 Sample Function Menu Screen

3. Tap the **Intelligent Diagnostics icon**  to the right of the DTC description. Or select a specific DTC from the DTC list, and then tap the **Intelligent Diagnostics button** at the bottom of the screen.

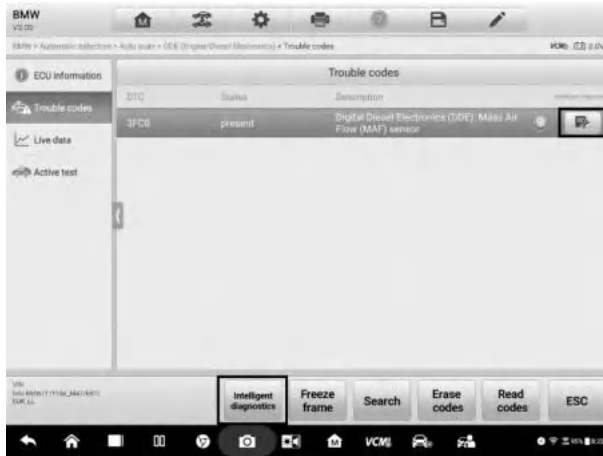

Figure 5-14 Sample Trouble Codes Screenshot

5.2 Intelligent Diagnostics Operation

Intelligent Diagnostics is an important and powerful function of MaxiSys Ultra. It provides substantial information for intelligent diagnosis of the faults detected, offering Technical Service Bulletin, DTC Analysis, Repair Assist, Repair Tips, and Component Measurement to help you repair detected faults. It also provides relevant case information for viewing.



Figure 5-15 Sample Intelligent Diagnostics Layout

The **Intelligent Diagnostics** function consists of the following sections:

1. **Vehicle System and Detected DTC(s)** – displays the name of the vehicle system(s) and the detected DTC(s).
2. **Technical Service Bulletin** – contains DTC-related recalls, TSB, and OEM campaigns.
3. **DTC Analysis** – provides repair assistance information related to the fault code.
4. **Repair Assist** – intelligently prioritizes DTCs and leads the user to the proper repair.
5. **Repair Tips** – details the steps for determining and clearing faults.
6. **Component Measurement** – provides detailed information and instructional guides on using the oscilloscope to test components for faults.
7. **Relevant Cases** – offers relevant fault-clearing repair cases for reference.

5.2.1 Vehicle System and Detected DTC(s)

This section displays the scanned vehicle systems that contain faults. Tap the drop-down menu to view comprehensive information of ALL systems or switch to different fault codes for details.

Tap the arrow button on the right to display a drop-down list of all systems along with specific DTCs. Use your finger to touch and slide upward or downward on the screen to review all codes in the list. Select ALL systems or select a DTC to view the corresponding Intelligent Diagnostics information.



Figure 5-16 Sample Vehicle System and Detected DTC(s) Screen

5.2.2 Technical Service Bulletin (OEM Information)

The Technical Service Bulletin function matches the selected fault code with relevant vehicle manufacturer TSBs. All TSBs that relate to the selected DTC are listed in the TSB display window. Select a TSB to open the TSB page and view the TSB in details.



Figure 5-17 Sample TSB Screen

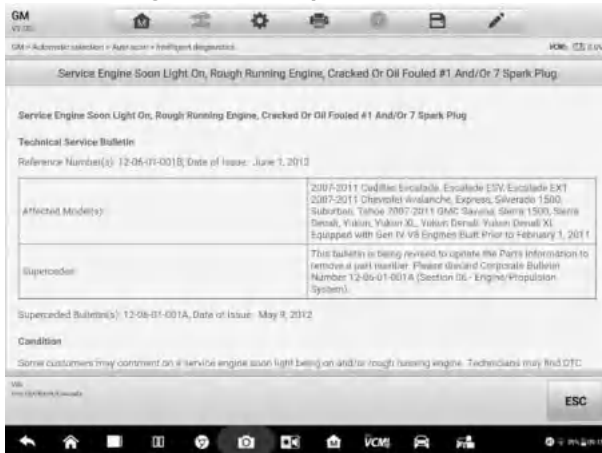

Figure 5-18 Sample TSB in Details

5.2.3 DTC Analysis

On the **Intelligent Diagnostics** screen, the DTC Analysis contains repair assistance and information related to the fault codes, including the fault description, condition, fault influence, possible cause, and possible solution. The repair assistance information may vary by vehicle.



Figure 5-19 Sample DTC Analysis Screen

5.2.4 Repair Assist

The Repair Assist displays a list of items and their descriptions, completion status, and priorities. The higher the priority number is (1 is the highest), the earlier the related items should be tested.

➤ To perform Repair Assist

1. Tap **Repair Assist** button on the Intelligent Diagnostics screen to open the page.



Figure 5-20 Sample Repair Assist Screen 1





2. Tap the **Run icon**  on the right to perform the selected item. Simply follow the screen prompts and make a series of choices.



Figure 5-21 Sample Repair Assist Screen 2

Table 5-2 Completion Status in Repair Assist

Completed		This indicates that all branches of the procedure are completed.
Uncompleted		This indicates that certain branches of the procedure is uncompleted.
Not running		This indicates that no branch of the procedure has run.

3. Tap the **Continue** button to go to the next step. Please note that when there are more than one DTCs in Select Branch, the ones that have run would be highlighted in blue.



Figure 5-22 Sample Repair Assist Screen 3

- In this repair process, it may integrate one or more diagnostic functions such as Read Codes, Erase Codes, Live Data, Freeze Frame and Active Test as needed.



Figure 5-23 Sample Repair Assist Screen 4



- In some cases, it is necessary to check the circuits. Take **Figure 5-24** for example, tap the first **Link icon**  to open the *Location Diagram*, and it will show the location of the component *Intake Camshaft Position Actuator Solenoid Valve* in the car.



Figure 5-24 Sample Repair Assist Screen 5

6. Tap the second **Link icon**  to open the *Wiring Diagram* to locate the related wirings. Tap the legend button  in the upper right corner, and you will be able to locate the components, connectors, wiring, and ground electrodes by tapping the names in the list when necessary.

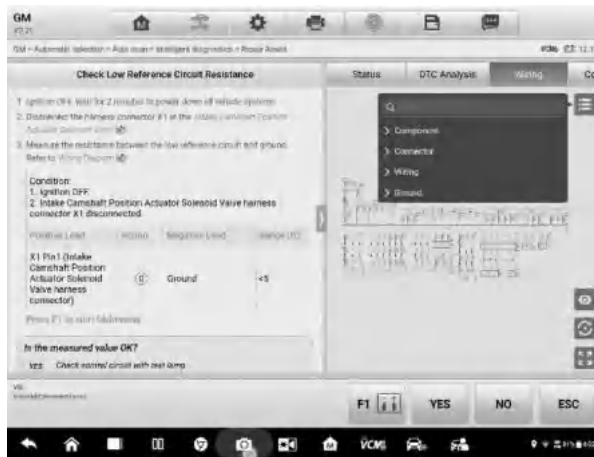



Figure 5-25 Sample Repair Assist Screen 6

7. If you want to view details of the connector, tap the **Link icon**  before the names in the list, then you will see the picture.

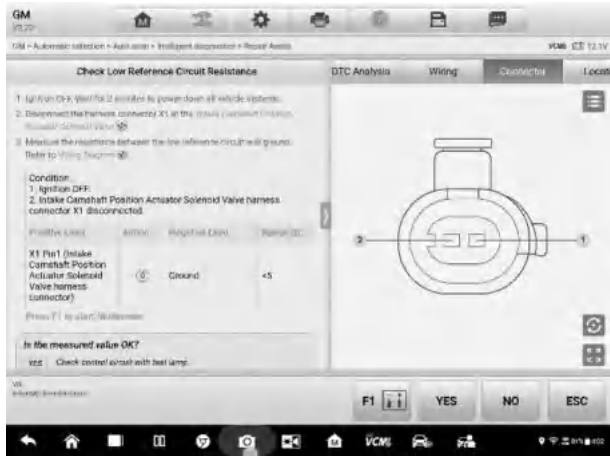

Figure 5-26 Sample Repair Assist Screen 7

8. Connect the multimeter to the related PINs and start the measurement. The parameters are already set properly in the device. All you need to do is to observe if the measured value is ok or not.

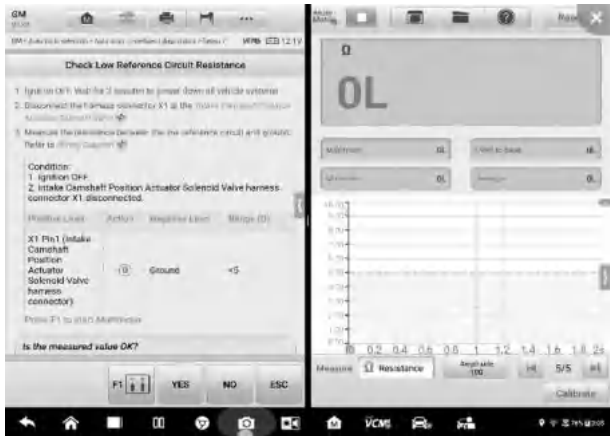

Figure 5-27 Sample Repair Assist Screen 8

9. After the inspection finishes, a solution will be generated to guide you to solve the problem with some reference information.



Figure 5-28 Sample Repair Assist Screen 9

NOTE

Operation instructions of the *Wiring Diagram* are as follows:

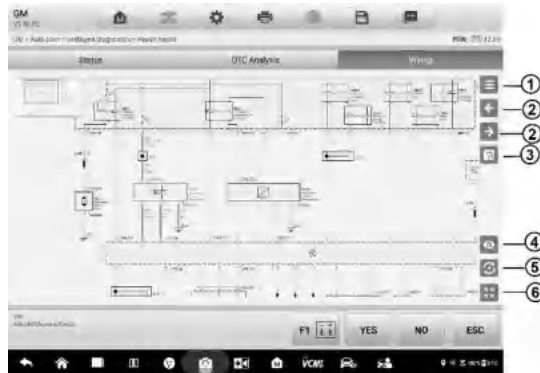











Figure 5-29 Sample Repair Assist Screen 10

1. Tap this button  to search or tap a certain module name to locate it. After location, the related wires will be highlighted. Also, you can directly tap a certain module in the diagram to highlight it and the related wires.
2. Tap this button  to switch to the last one or tap this button  to switch to the next one.
3. Tap this button  to find what you have previously viewed.
4. Tap this button  to hide the unrelated wires, and tap this button  to show the hidden wires.

5. Tap this button  to restore the initial settings.
6. Tap this button  to exit the full screen, and tap this button  to enter the full screen.

5.2.5 Repair Tips

The Repair Tips function displays a range of diagnostic and repair steps, including the information needed in order to clear the faults. The repair steps are provided in text and video.



Figure 5-30 Sample Repair Tips Description 11 (Text)

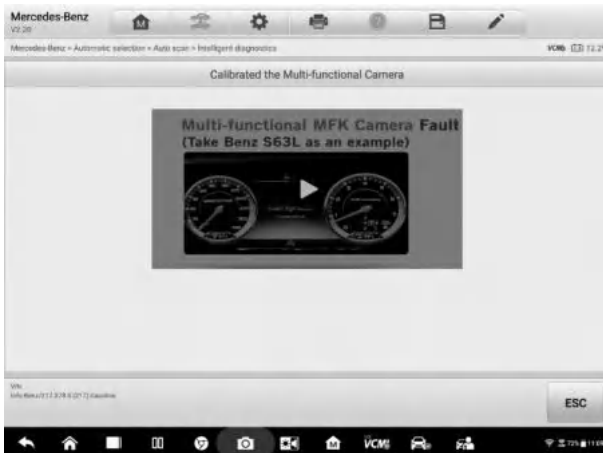

Figure 5-31 Sample Repair Tips Description 12 (Video)

5.2.6 Component Measurement

The component measurement section provides a general troubleshooting overview, and guides to connect and use the oscilloscope to test components for faults. This section may include relevant circuit or wiring diagrams, vehicle structures analysis, waveform analysis, related DTCs, and detailed notation to aid the technician in diagnostics and repairs.

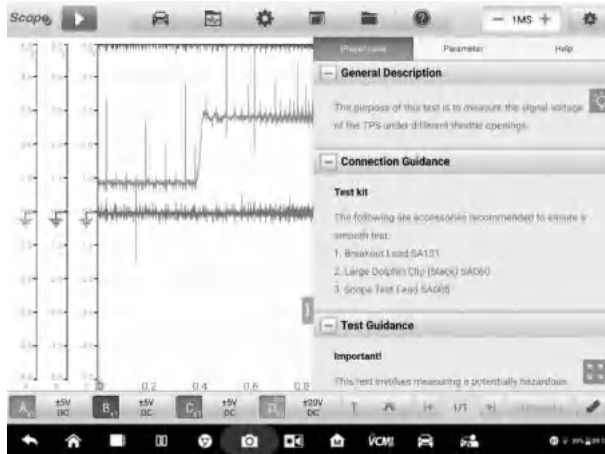

Figure 5-32 Sample Component Measurement Screen 13

5.2.7 Relevant Cases

This section offers recommended repair cases that may be relevant to the current vehicle and/or the current fault. These repair cases may provide greater insight into diagnosing and repairing your vehicle. Tap the related case to review.



Figure 5-33 Sample Relevant Cases Screen 14

- **To review relevant cases information**
 1. Tap the **Relevant Cases** icon to display main page.
 2. Scroll through the page and to locate relevant information.
 3. Tap the arrow icon at the left top and return to the previous repair case page.

6 Service

The **Service** section is specially designed to provide quick access to the vehicle systems for various scheduled service and maintenance tasks. The typical service operation screen is a series of menu driven executive commands. Follow on-screen instructions to select appropriate execution options, enter correct values or data, and perform necessary actions. The application will display detailed instructions to complete selected service operations.

After entering each special function, the screen will display two application choices: **Diagnosis** and **Hot Functions**. The **Diagnosis** enables the reading and clearing of codes which is sometimes necessary after completing certain special functions. **Hot Functions** consists of sub functions of the selected special function.



Figure 6-1 Sample Service Menu

Several most commonly used services are described in this chapter.

6.1 Oil Reset Service

Perform reset for the Engine Oil Life system, which calculates an optimal oil life change interval depending on the vehicle driving conditions and climate. The Oil Life Reminder must be reset each time the oil is changed, so the system can calculate when the next oil change is required.

NOTE

1. Always reset the engine oil life to 100% after every oil change.

2. All required work must be carried out before the service indicators are reset. Failure to do so may result in incorrect service values and cause DTCs to be stored by the relevant control module.
 3. For some vehicles, the scan tool can reset additional service lights such as maintenance cycle and service interval. On BMW vehicles for example, service resets include engine oil, spark plugs, front/rear brakes, coolant, particle filter, brake fluid, micro filter, vehicle inspection, exhaust emission inspection and vehicle checks.
-

6.2 Electric Parking Brake (EPB) Service

This function has a multitude of usages to maintain the electronic braking system safely and effectively. The applications include deactivating and activating the brake control system, assisting with brake fluid control, opening and closing brake pads, and setting brakes after disc or pad replacement.

6.2.1 EPB Safety

It can be dangerous to perform Electric Parking Brake (EPB) system maintenance, so before you begin the service work, please keep these rules in mind.

- ✓ Ensure that you are fully familiar with the braking system and its operation before commencing any work.
- ✓ The EPB control system may be required to be deactivated before carrying out any maintenance/diagnostic work on the brake system. This can be done from the tool menu.
- ✓ Only perform maintenance work when the vehicle is stationary and on level ground.
- ✓ Ensure that the EPB control system is reactivated after the maintenance work has been completed.

NOTE

Autel accepts no responsibility for any accident or injury arising from the maintenance of the Electric Parking Brake system.

6.3 Tire Pressure Monitoring System (TPMS) Service

This function allows you to quickly look up the tire sensor IDs from the vehicle's ECU, as well as to perform TPMS replacement and reset procedures after tire sensors are replaced.

6.4 Battery Management System (BMS) Service

The Battery Management System (BMS) allows the tool to evaluate the battery charge state, monitor the close-circuit current, register the battery replacement, activate the rest state of the vehicle, and charge the battery via the diagnostic socket.

NOTE

1. This function is not supported by all vehicles.
2. The sub functions and actual test screens of the BMS may vary by vehicle, please follow the on-screen instructions to make correct option selection.

The vehicle may use either a sealed lead-acid battery or an AGM (Absorbed Glass Mat) battery. Lead acid battery contains liquid sulphuric acid and can spill when overturned. AGM battery (known as VRLA battery, valve regulated lead acid) also contains sulphuric acid, but the acid is contained in glass mats between terminal plates.

It is recommended that the replacement aftermarket battery has the same specifications, such as capacity and type, as the exiting battery. If the original battery is replaced with a different type of battery (e.g. a lead-acid battery is replaced with an AGM battery) or a battery with a different capacity (mAh), the vehicle may require reprogramming of the new battery type, in addition to, performing the battery reset. Consult the vehicle manual for additional vehicle-specific information.

6.5 Diesel Particle Filter (DPF) Service

The Diesel Particle Filter (DPF) function manages DPF regeneration, DPF component replacement teach-in and DPF teach-in after replacing the engine control unit.

The ECM monitors driving style and selects a suitable time to employ regeneration. Cars driven a lot at idling speed and low load will attempt to regenerate earlier than cars driven more with higher load and speed. In order for regeneration to take place, a prolonged high exhaust temperature must be obtained.

In the event of the car being driven in such a way that regeneration is not possible, i.e., frequent short journeys, a diagnostic trouble code will eventually be registered in addition to the DPF light and "Check Engine" indicators displaying. A service regeneration can be requested in the workshop using the diagnostic tool.

Before performing a forced DPF regeneration using the tool, check the following items:

- The fuel light is not on.
- No DPF-relevant faults are stored in system.
- The vehicle has the specified engine oil.
- The oil for diesel is not contaminated.

! IMPORTANT

Before diagnosing a problem vehicle and attempting to perform an emergency regeneration, it is important to obtain a full diagnostic log and read out relevant measured value blocks.

🔧 NOTE

1. The DPF will not regenerate if the engine management light is on, or there is a faulty EGR valve.
 2. The ECU must be re-adapted when replacing the DPF and when topping up the fuel additive Eolys.
 3. If the vehicle needs to be driven in order to perform a DPF service, a second person is needed for the function. One person should drive the vehicle while the other person observes the screen on the Tool. Do not attempt to drive and observe the scan tool at the same time. This is dangerous and puts your life and the lives of other motorists and pedestrians at risk.
-

6.6 Immobilizer (IMMO) Service

An immobilizer is an anti-theft mechanism that prevents an automobile's engine from starting unless the correct ignition key or other device is present. This device prevents thieves from starting the car by a method known as hot wiring. Most new vehicles have an immobilizer as standard equipment. An important advantage of this system is that it doesn't require the car owner to activate it; it operates automatically. An immobilizer is considered as providing much more effective anti-theft protection than an audible alarm alone; many auto insurance companies offer lower rates for vehicles that are equipped with an immobilizer.

As an anti-theft device, an immobilizer disables one of the systems needed to start a car's engine, usually the fuel supply or the ignition. This is accomplished by radio frequency identification between a transponder in the ignition key and a device called a radio frequency reader in the steering column. When the key is placed in the ignition, the transponder sends a signal with a unique identification code to the reader, which relays it to a receiver in the vehicle's computer control module. If the code is correct, the computer allows the fuel supply and ignition systems to operate and start the car. If the code is incorrect or absent, the computer disables the system, and the car will be unable to start until the correct key is placed in the ignition.

The IMMO service can disable a lost vehicle key and program the replacement key fob. One or more replacement key fobs can be programmed.

6.7 Steering Angle Sensor (SAS) Service

Steering Angle Sensor Calibration permanently stores the current steering wheel position as the straight-ahead position in the steering angle sensor EEPROM. Therefore, the front wheels and the steering wheel must be set exactly to the straight-ahead position before calibration. In addition, the vehicle identification number (VIN) is also read from the instrument cluster and stored permanently in the steering angle sensor EEPROM. On successful completion of calibration, the steering angle sensor fault memory is automatically cleared.

Calibration must always be carried out after the following operations:

- Steering wheel replacement
- Steering angle sensor replacement
- Any maintenance that involves opening the connector hub from the steering angle sensor to the column
- Any maintenance or repair work on the steering linkage, steering gear or other related mechanism
- Wheel alignment or wheel track adjustment
- Accident repairs where damage to the steering angle sensor or assembly, or any part of the steering system may have occurred

NOTE

1. Autel accepts no responsibility for any accident or injury arising from servicing the SAS system. When interpreting DTCs retrieved from the vehicle, always follow the manufacturer's recommendation for repair.
 2. All software screens shown in this manual are examples, actual test screens may vary by test vehicle. Pay attention to the menu titles and onscreen instructions to make correct option selections.
 3. Before starting procedure, make sure vehicle has an ESC button. Look for button on dash.
-

7 Measurement

The Measurement application can provide all the features needed for performing electrical and electronic circuit tests as well as monitoring signal activities on today's vehicles.

After properly connecting with a test vehicle and communicating with MaxiSys Ultra, the VCMI (Vehicle Communication and Measurement Interface) is used as an integrated device that functions as an oscilloscope, a waveform generator, a multimeter and a digital OBDII breakout box.

7.1 Oscilloscope

An oscilloscope is a measuring instrument that shows how a signal varies with time in a graphical way. Various signal activities can be displayed and monitored on a two-dimensional grid. The graphical form created by a signal is called a waveform. The voltage-time characteristic of the signal or waveform is drawn as a visual line called the trace.

7.1.1 Safety Information

Follow these instructions below to reduce the risk of injury from electric shock and prevent equipment damage.

A. Maximum input ranges

Observe all terminal ratings and warnings marked on the product.



DANGER:

- To prevent electric shock, take all necessary safety precautions when working on equipment where voltages beyond the specified input range may exist. Contact with voltages outside of the specified measuring range presents a risk of electric shock.
- To prevent injury or death, the oscilloscope must not be directly connected to the battery. To measure battery voltages, use a differential isolating probe specifically rated for battery use.

 **WARNING:**

- Operation outside of the safe input range is likely to cause permanent damage to the oscilloscope and other connected equipment.

B. Grounding

 **DANGER:**

- The scope's ground connection through the USB cable is for measurement purposes only. The oscilloscope does not have a protective safety ground.
- Do not connect the ground input (chassis) to any electrical power source. To prevent personal injury or death, use a voltmeter to check that there is no significant AC or DC voltage between the oscilloscope ground and the point to which you intend to connect the ground input.

 **WARNING:**

- Applying a voltage to the ground input is likely to cause permanent damage to the oscilloscope, the attached computer, and other equipment.
- To prevent measurement errors caused by poor grounding, always use the high-quality USB cable supplied with the oscilloscope or Wi-Fi connection.

C. External connections

 **DANGER:**

- To prevent injury or death, use only the power cord and adaptor supplied with the product.

D. Environment

 **DANGER:**

- To prevent injury or death, do not use the product in wet or damp conditions, or around explosive gas or vapor.

 **WARNING:**

- To prevent damage, always use and store your oscilloscope in appropriate environments.

E. Product Maintenance

The product contains no user-repairable parts. Repair, servicing and calibration require specialized test equipment and must be performed by Autel Tech Support or an approved service provider.

⚠ DANGER:

- To prevent injury or death, do not use the product if it appears to be damaged in any way. Stop using the product when any abnormal operations occur.

⚠ WARNING:

- Do not tamper with or disassemble the oscilloscope, connectors or accessories. Internal damage will affect performance.
- Do not block any of the instrument's air vents to avoid damage caused by overheating.
- When cleaning the oscilloscope, use wet soft cloth with mild detergent in water. Do not allow water to enter the oscilloscope casing.

7.1.2 General Introduction

7.1.2.1 Component Locations

The input channels are located at the bottom of the VCMI device and are compatible with many test leads and probes.

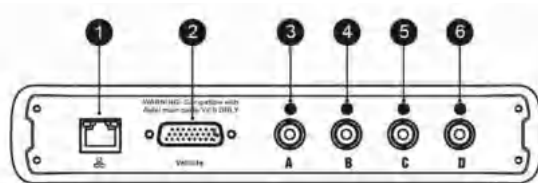

VCMI Bottom View

1. Ethernet Connector – Connects to RJ45 Network Cable
2. Vehicle Data Connector – Connects to the vehicle DLC using the provided Main Cable.
3. Input Channel A
4. Input Channel B
5. Input Channel C

6. Input Channel D

The oscilloscope LED is located on the front panel of the VCMI device. When the VCMI is properly connected and powered on, the oscilloscope LED flashes green when operating in the oscilloscope mode.

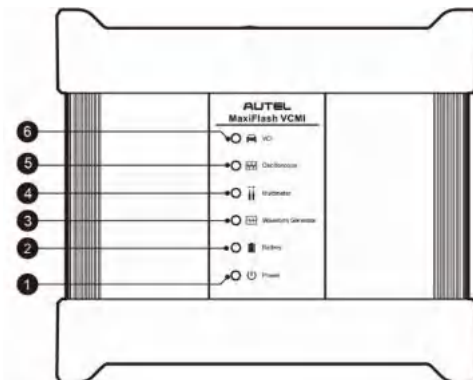

VCMI Front View

1. Power LED
2. Battery LED
3. Waveform Generator LED
4. Multimeter LED
5. Oscilloscope LED
6. Vehicle LED

7.1.2.2 Technical Specifications

Table 7-1 Technical Specifications

Item	Description
Channels	4
Bandwidth	20MHz

Item	Description
Maximum Sample Rate	<ul style="list-style-type: none"> ● 1 or 2 channels: 80MS/s* ● 3 or 4 channels: 20MS/s* <p>* MS/s = mega samples per second</p> <p>1) Select arbitrary one channel, the maximum sample rate is 80MS/s.</p> <p>2) Select two channels (AC, BC, AD, or BD), the maximum sample rate is also 80MS/s.</p> <p>3) Select two channels (AB/CD) or more than three channels, the maximum sample rate is 20MS/s.</p>
Input Ranges (Full Scale)	±50 mV to ±200V
Sensitivity	10 mV/div to 40V/div
Input Coupling	AC/DC
Input Impedance	1MΩ in parallel with 25pF
Vertical Resolution	12 bits
Buffer Memory	32M samples shared among active channels
Time Base Ranges	100ns/div to 1000s/div
Connection	<ul style="list-style-type: none"> ● USB 2.0 ● Wi-Fi
Max. Wi-Fi Transmission Distance	Up to 98ft
DC Accuracy	±1% of full scale
Storage Humidity Range	5 to 95%RH, non-condensing

7.1.2.3 Accessories



Autel USB Cable V2 (the V2 icon can be seen on the cable) (SA001)

Connects the oscilloscope to the tablet to ensure reliable

signal transmission.



Secondary Ignition Pickup (SA273)

The BNC connector is connected to the oscilloscope to measure the secondary ignition voltage of conventional ignition systems and most HEI (High Energy Ignition) and DIS (Distributorless Ignition) systems.



Scope Test Lead

(Red: SA005, Green: SA006, Blue: SA007, Yellow: SA008)

The BNC connector is connected to the oscilloscope, and the 4mm banana plug is connected to various probes.



Breakout Lead (SA151)

Enables easy access to existing automotive wiring harness connectors for obtaining signals of various sensors. Four sizes are available: 0.6 mm, 1.5 mm, 2.3 mm and 2.8 mm.



Flexible Back-pinning Probe (Red: SA053, Black: SA054)

Designed for back-probing under the insulation of multi-plug terminals to detect the signal of the test component. The flexible part can be bent and access to difficult areas. The probe tip is not replaceable.



Back-pinning Probe Set (SA051)

Designed for back-probing under the insulation of plugs to pick up the signal of the test component. The probe tip is replaceable.



Multimeter Probe (Red: SA055, Black: SA056)

Designed for connecting exposed wires or terminals.



Small Crocodile Clips (Red: SA057, Black: SA058)

Used to connect exposed wires or terminals. SA059 (red) and SA060 (black) for larger terminals.



Large Dolphin Clips (Red: SA059, Black: SA060)

Used to connect exposed wires or terminals, including battery terminals. SA057 (red) and SA058 (black) for smaller terminals.



Attenuators 20:1 (SA020)

Passive 20:1 attenuator, can output 1V when inputting a 20V signal.



Battery Clip (Optional) (Red: SA061, Black: SA062)

Dedicated to connecting car battery terminals.



65A AC/DC Current Clamp (Optional) (SA253)

Used to measure AC or DC currents up to 65A. Two scales are available: 1mV/10mA for 10mA to 20A, 1mV/100mA for 10mA to 65A.



650A AC/DC Current Clamp (Optional) (SA256)

Used to measure AC or DC currents up to 650A. Two scales are available: 1mV/100mA for 100mA to 200A, 1mV/1A for 100mA to 650A.



Coil On Plug (COP) Probe (Optional) (SA271)

Used with the oscilloscope to measure the secondary ignition voltage of COP.



HT Extension Lead (Optional) (SA275)

Fit the HT extension leads between the coil pack and the plugs of the independent ignition system (COP), and then place the (SA273) secondary ignition pickup on each lead to obtain the secondary ignition voltage.

7.1.3 Getting Started

Before opening the Oscilloscope application, the VCMI device must be connected to the tablet via the provided USB cable or Wi-Fi network. For more information, see [Establish Vehicle Communication](#) on page 20.

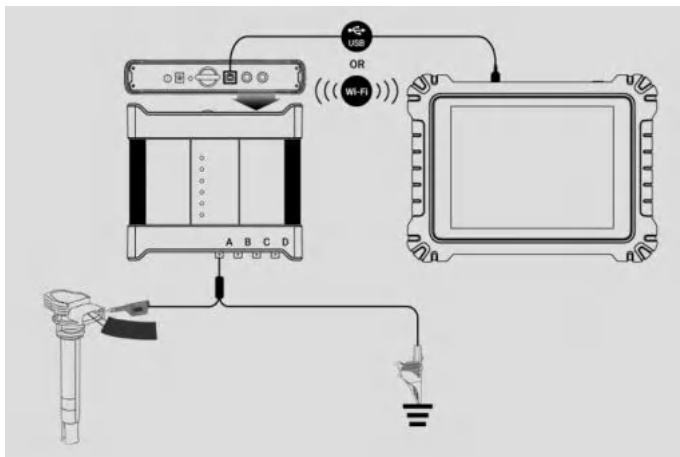

Figure 7-1 Sample Connection Diagram

➤ To open the oscilloscope application

1. Insert the applicable test lead or probe terminal ends into the input channel(s) to complete the connection (refer to **Figure 7-1**).
2. Tap the **Measurement** icon on the Home screen of the MaxiSys Ultra Tablet. The Measurement screen opens.
3. Tap the **Oscilloscope** icon to open the oscilloscope menu.
4. Select a desired testing option to continue.

 **NOTE**

Please check the oscilloscope LED status indicator on the front panel of VCMI device. The oscilloscope LED flashes green when operating in the oscilloscope mode.

Message Prompt

A message showing "Are you sure to open the waveform of Demo mode?" displays after tapping the Oscilloscope icon and opening the oscilloscope menu. Please tap "**OK**" to enter the demo mode or tap "**Cancel**" to exit.

A message showing "Are you sure to open the waveform data?" also displays after the tablet and the VCMI connect successfully. Please tap "**OK**" to display the actual waveform or tap "**Cancel**" to exit.

7.1.4 Oscilloscope Update

The operating software of the oscilloscope is continually optimized. Tap the **Help** button in the top toolbar and then tap the **Update the APK** button in the dropdown list to update the software.

Before update the oscilloscope's software, please make sure the tablet has a stable Internet connection.

7.1.4.1 APK Update

 **NOTE**

The acronym APK (Android Package Kit) is used on the tablet and in this manual. This file contains all the assets of a particular app. To update the APK, is to install the latest version of the app on your tablet.

➤ **To update the APK**

1. Tap the **Help** button on the upper half of the screen. A dropdown menu displays.



Figure 7-2 Sample Help Screen

2. Tap the **Update the APK** in the dropdown menu. A confirmation message displays.

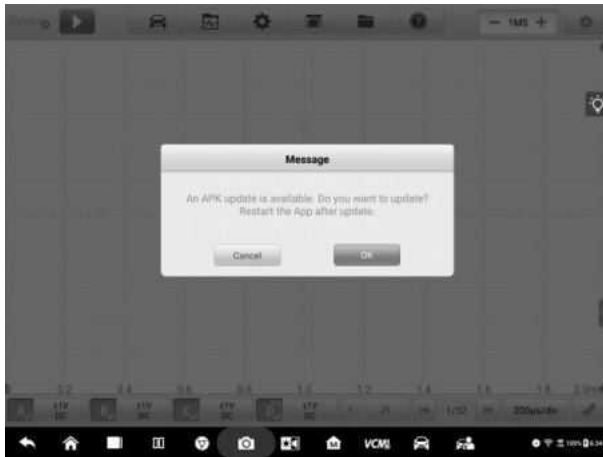

Figure 7-3 Sample Update Confirmation Screen

3. Tap **OK** to update the software or tap **Cancel** to exit.

7.1.4.2 Firmware Update

- **To update the firmware**

1. Tap the **Help** button on the upper half of the screen. A dropdown menu displays. (*Figure 7-2*)
2. Tap **Update Firmware** in the dropdown list. The screen will switch to the **Update** section in the **VCMI Management** application.



NOTE

Please **DISCONNECT** the MaxiScope from VCMI before updating. A message displays and tap "OK" to confirm that you have disconnected MaxiScope from VCMI.



Figure 7-4 Sample Firmware Update Screen 1

3. The current version and the latest version of the OS, firmware, and scope firmware will display. Tap **Update Now** to update. Please do not leave the update page during upgrade. It takes about 5-15 minutes for the whole process.



Figure 7-5 Sample Firmware Update Screen 2

7.1.5 Screen Layout and Operations

The Oscilloscope application measures changing voltages of an electrical system over a period of time. This signal is depicted as a shape. The grid on the screen shows divisions of voltage and time to enable measurements to be made.

Tap the **Measurement** icon on the home screen then select **Oscilloscope** in the menu, the oscilloscope page displays. The screen typically includes the following sections.

NOTE

The Oscilloscope application can also be opened via the Android home screen. Tap the **Measurement** icon at the top of the Android home screen. Tap **Oscilloscope** icon.

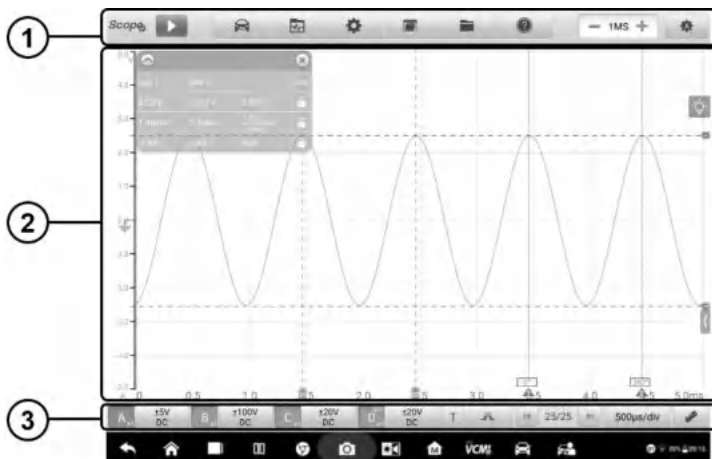



Figure 7-6 Sample Oscilloscope Menu Screen





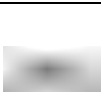

1. Upper Toolbar - see [Upper Toolbar](#) on page 101 for details.
2. Main View Section – see [Main View Section](#) on page 130 for details.
3. Lower Toolbar - see [Lower Toolbar](#) on page 138 for details.

7.1.5.1 Upper Toolbar

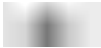
The upper toolbar is used for configurations of various settings and operations. The following table provides brief descriptions of each button.

Table 7-2 Scope Navigation Toolbar

Name	Button	Description
Scope Icon		Indicates the oscilloscope connection status. See Scope Icon on page 102 for more information.
Start/Stop		Start or stop the oscilloscope device. See Start/Stop Button on page 102 for more information.
Presets		Access preset guide. Select preset to correctly configure oscilloscope to capture a waveform of the specified type. See Presets Menu on page 103 for more information.



Name	Button	Description
Waveform Library		Search, upload, share, open, load as reference waveform, and follow the waveforms in the waveform library. See Waveform Library on page 106 for more information.
Settings		Configurations of mode setting, math channels, waveform generator, decoding setting, startup setting and demo setting. See Settings Menu on page 110 for more information.
Window Display		Set the layout and channel position. See Window Display Menu on page 123 for more information.
File		Print, open, save, delete the waveform data or upload the waveform to waveform library. Moreover, save, import the configuration and open the recent documents. See File Menu on page 127 for more information.
Help		View the user manual, update the APK (oscilloscope software) and firmware. See Help Menu on page 128 for more information.
Number of Samples		Set the maximum number of samples that will be captured on each channel. See Number of Samples on page 129 for more information.
Auto Scale		Set the appropriate amplitude range to display the signal correctly. See Auto Scale on page 129 for more information.

Scope Icon

This **Scope icon** displays the oscilloscope connection status. A **green check mark** means the tablet and oscilloscope are connected successfully; a **red X** means the tablet and the scope are not connected.

Start/Stop Button

Tap the **Start/Stop Button** icon to start or stop the oscilloscope device.

Name	Button	Description
Start		Tap to start the oscilloscope and initiate sampling.
Stop		Tap to stop the oscilloscope and terminate sampling.

Presets Menu

Tap the vehicle icon button in the top navigation bar to enter the **Presets Menu**. This menu offers a wide variety of preset guided information for you to view.

The frequently used test components and options are listed in the presets menu:

- **Actuators** - Test the common car actuators such as injectors, fuel pumps, and canister purge solenoids.
- **Battery Charging** - Test the functions related to car charging, including current and voltage idle test.
- **Combination Test** - Combined test of the vehicle's sensors or actuators, such as the crankshaft position sensor and camshaft position sensor test; the primary ignition and crankshaft position test; the throttle position sensor and front oxygen sensor test.
- **Data Communication** - Test the vehicle communication buses including CAN-bus, LIN-bus, and K-Line.
- **Engine Starting** - Test the functions related to car starting, including starting current and voltage test.
- **Ignition Systems** - Test the ignition process of the vehicle, including the voltage and current test of the primary and secondary ignition.
- **Sensors** - Test the common car sensors such as oxygen sensors, camshaft sensors, and crankshaft sensors.

NOTE

Do not connect to High-voltage control signal such as the ignition control wire. It may cause the damage to the product. The measured voltage value during the actuator test may be different from the actual value.

➤ To use the Presets menu

1. Tap the **Presets** button in the top navigation bar. A submenu opens.
2. Tap the desired test component or option in the left column.

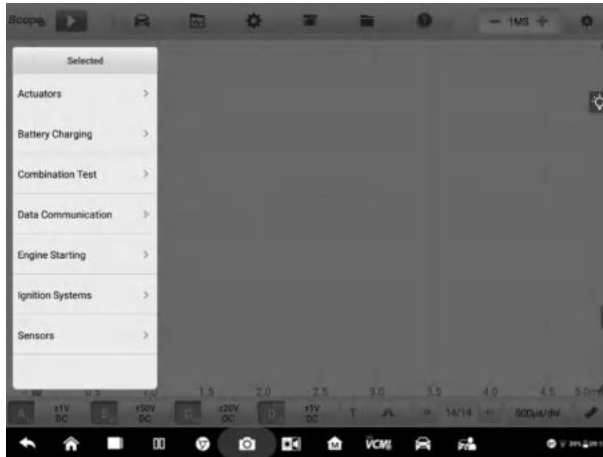



Figure 7-7 Sample Presets Menu Screen 1

3. Tap an option you need from the submenu, and if there is no preset case or the version of the preset case is too low, tap the  button to download the new preset case you need. If the current preset case is already a new version, the download button  will not be displayed.

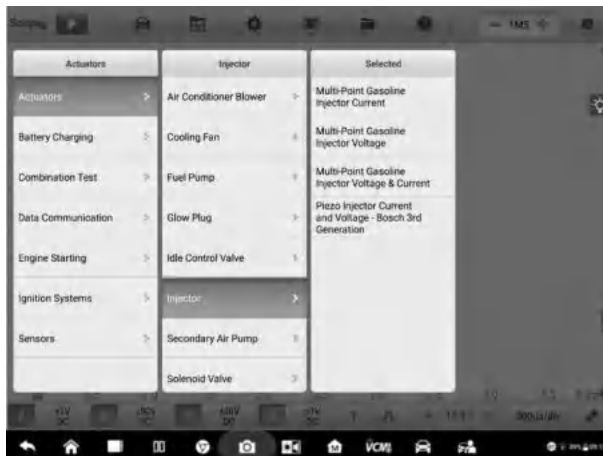

Figure 7-8 Sample Presets Menu Screen 2

4. View the preset guided information. A reference signal waveform displays (an injector selection is used here as an example) on the Main Screen and the preset guided information on the right side of the screen.

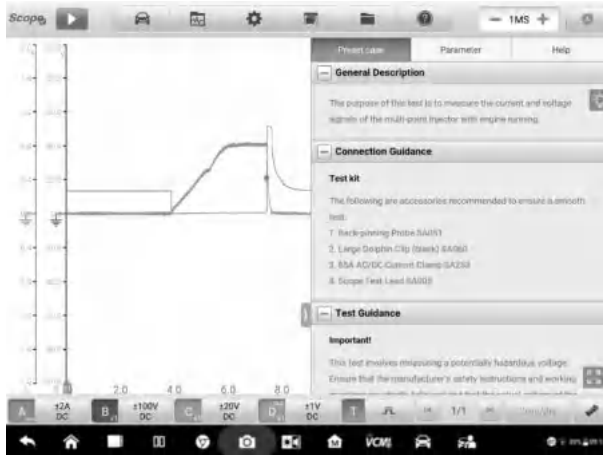

Figure 7-9 Sample Presets Display Screen

5. Tap the arrow button to hide the preset guided information and display the waveform.

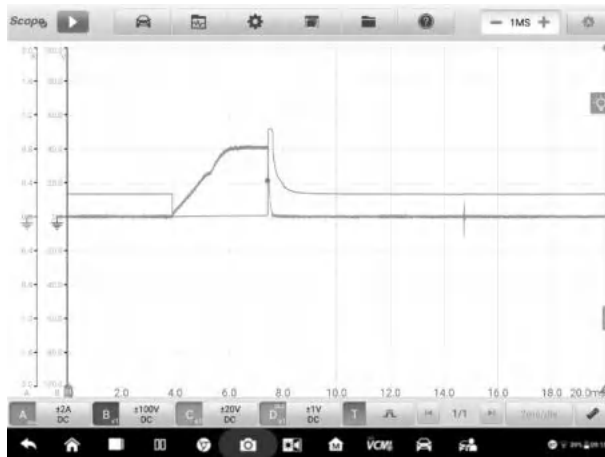

Figure 7-10 Sample Reference Signal Waveform Display

NOTE

Parameter values such as the ranges of voltage and time divisions are automatically set for presets.

6. Tap the four-directional arrow icon in the lower right corner to display the preset

guided information, including the general description, connection guidance, connection diagram, test guidance, real vehicle connection, waveform analysis and related DTCs in full screen. Tap again to exit full screen.

NOTE

Images in the preset guided information can be displayed in a full screen for viewing in details.

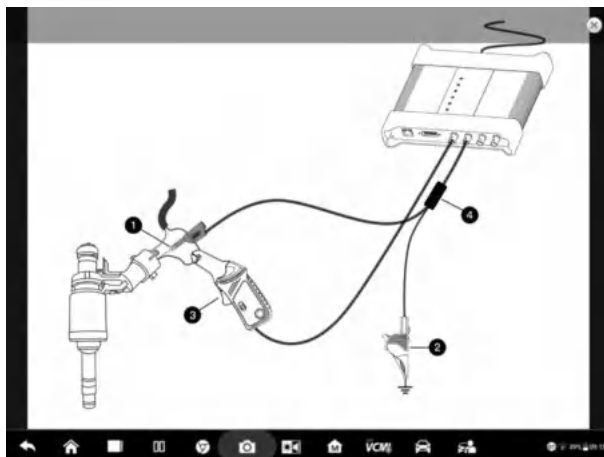

Figure 7-11 Sample Image Display (Full Screen)

7. Tap the **Start/Stop** button. The oscilloscope will perform waveform acquisition according to the preset parameters.

Waveform Library

Tap the waveform icon in the top navigation bar to open the **Waveform Library Page**. The waveform library includes online waveform library and local waveform library.

Online Waveform Library

The waveforms in the online waveform library are picked and uploaded by Autel users during repair and test process using an oscilloscope. It allows you to search for the waveforms from the vehicle and component you want to test, or upload and share your own waveforms.

The search result displays the information such as the waveform picture, waveform ID, VIN code, vehicle code, etc. The waveform in the online library can also be loaded as reference waveform for better waveform analysis.

There are two methods to search for waveforms: Condition-based search and keyword-based search.

- **Condition-based Search**

On the condition-based search page, the waveform(s) can be accurately searched after selecting the corresponding conditions, such as the vehicle model, test category, status, etc. Once you have searched a waveform, you can open, share the waveform ID to others, and follow as your favorite.

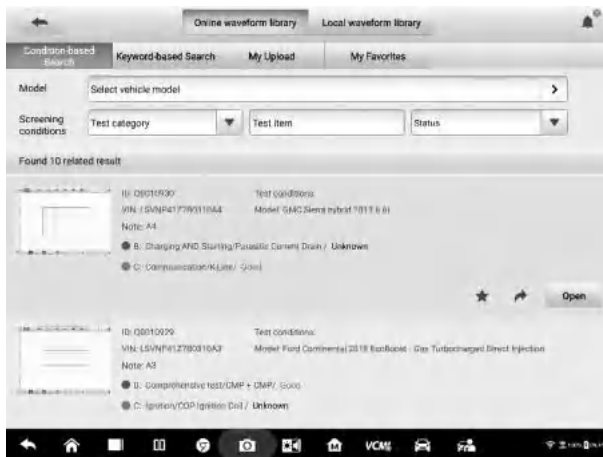

Figure 7-12 Sample Conditional-based Search Screen

(1) **Model:** Tap the input field or the arrow icon on the right to select the vehicle model. The manufacture and model should be selected from the column that displays.

(2) **Screening conditions**

Three screening conditions are available: Test category, test item and status.

Tap the dropdown menu to select the test category such as the actuators, battery charging, engine starting, or no selection.



Tap the dropdown menu to select the condition status: no selection, good or

bad.

(3) Search result

The search result will automatically display in the lower section of the page after selecting the model and conditions, showing the image of waveform, waveform ID, VIN or the screening conditions.

Tap the corresponding buttons on the lower right side to share, follow or open the waveform. Tap the **Load As Ref. Waveform** to load the waveform as a reference waveform for better waveform analysis.

Name	Button	Description
Share		Tap to display a waveform ID and you can share it through Twitter or Facebook to anyone you want.
Follow		Tap to follow the waveform as your favorite.
Open		Tap to open the waveform.

● Keyword-based Search

On the keyword-based search page, please input the waveform ID, VIN, vehicle code, or screening conditions and then tap the "Search" button to roughly search the waveform(s) you want. You can also scan the waveform code or VIN by tapping the Scan icon in the input field to search the waveform.

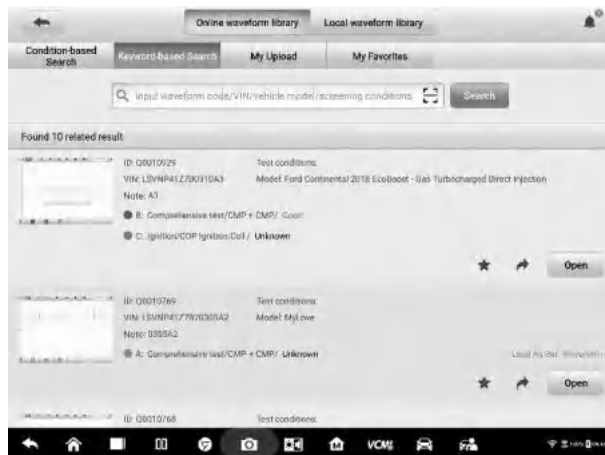

Figure 7-13 Sample Keyword-based Search Screen

- **My Upload**

Your own waveforms can be saved and uploaded to the online server. The uploaded waveforms can be searched from "My Upload" tab.

Please input the waveform code, VIN, vehicle code, or screening conditions and then tap the "Search" button to search the waveform(s) you have uploaded. The waveform can be opened, shared, followed, reviewed and loaded as a reference waveform once you have found it.

- **My Favorites**

All the waveforms you have searched in the Condition-based Search, Keyword-based Search or My Upload tab can be followed as My Favorites by tapping the five-point start button. The waveform can also be opened, shared, followed and loaded as a reference waveform.

Local Waveform Library

The waveforms in the local waveform library are the ones saved in the tablet.

Input the waveform code, VIN, vehicle code, or screening conditions and then tap the "**Search**" button to search the waveform(s) saved in the local library. The found result displays the picture of waveform, waveform ID, screening conditions, vehicle model, etc. The waveforms can be opened, loaded as reference waveforms, shared waveform codes, uploaded or batch uploaded.

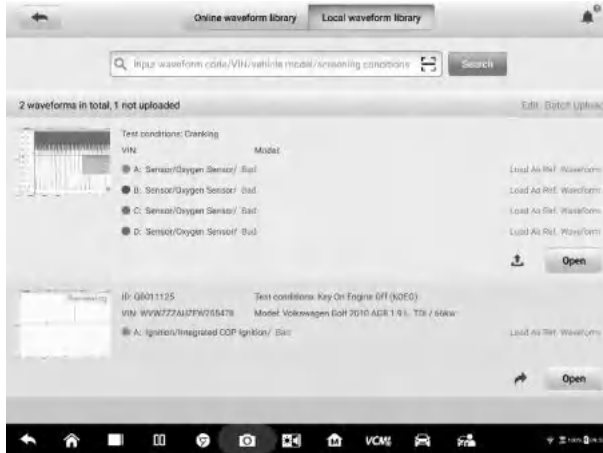

Figure 7-14 Sample Local Waveform Library Screen

Settings Menu

Tap the gear icon button in the top navigation bar to open the **Setting Menu**. The **Mode**, **Math Channels**, **Waveform Generator**, **Decoding Settings**, **Startup Settings** and **Demo Settings** can be manually configured in the menu.

Mode Settings

Two modes and three display views are available: normal mode, demo mode, oscilloscope view, XY view and spectrum view.



Figure 7-15 Sample Mode Setting Screen

In **Normal Mode**, the actual waveform is displayed on the screen when a test component is connected to the oscilloscope. You can real-time monitor the signal waveform of sensors in the normal mode.

NOTE

The oscilloscope is required to be connected in the normal mode.

In **Demo Mode**, a demo waveform is displayed on the screen. The sine wave, square wave, injector voltage, injector current, ignition signal, and crankshaft signal can also be displayed if you do not connect with the oscilloscope. The user can use this mode to familiarize him or herself with the functions of the oscilloscope.

The normal mode or demo mode can be selected with any one of these three views (oscilloscope view/XY view/spectrum view) at the same time to meet different signal display needs.

In the **Oscilloscope View**, the waveform shows how a signal varies with time in a graphical way.

In the **XY View**, the waveform shows the relationships between periodic signals, displaying a graph of one channel against another.

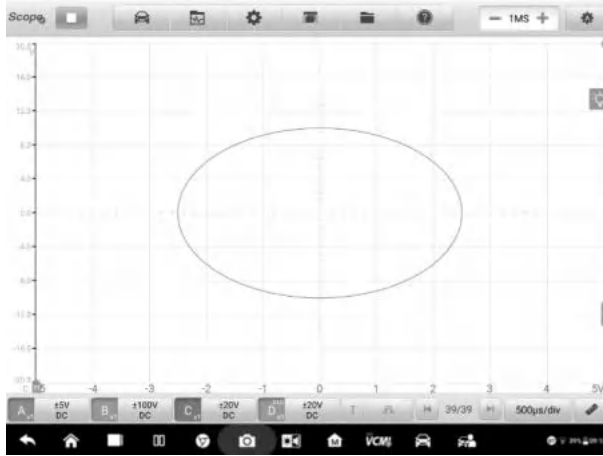

Figure 7-16 Sample XY View Setting Screen

In the **Spectrum View**, the waveform shows the signal level on a vertical axis against frequency on the horizontal axis in a graphical way. One or more spectra with a common frequency axis can be displayed in the spectrum view.

NOTE

The Wi-Fi connection does not support the XY View and Spectrum View. Please use the USB cable to connect the device, instead of the Wi-Fi connection.

The spectrum-related analysis options display after selecting the spectrum view in the Mode setting screen. Select the desired spectrum bins and window functions for better spectrum analysis.

The amplitude overrange of Y-axis can be adjusted by the amplitude level. When the sampling frequency is low, the current frequency can also be adjusted. The maximum frequency supports 20M.

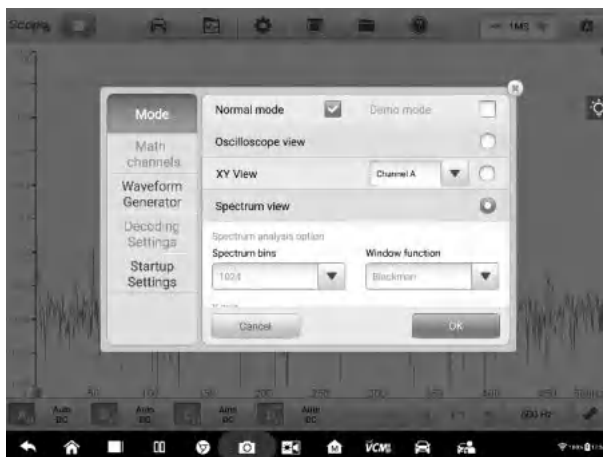

Figure 7-17 Sample Spectrum View Setting Screen 1

- **Spectrum Bins:** It allows you to set the number of frequency bins into which the spectrum is divided.
- **Window function:** It allows you to select one of the standard window functions to reduce the impact of running on a time-limited waveform.

Table 7-3 Window Function Table

Window	Main peak width (bins @ -3dB)	Highest side lobe (dB)	Side lobe roll-off (dB/octave)	Description
Rectangle	0.89	-13.2	6	No fading; maximal sharpness; used for short transients
Blackman	1.68	-58	18	Often used for audio work
Blackman-Harris	1.90	-92	6	Used for general purpose
Flattop	2.94	-44	6	Negligible pass-band ripple; mainly used for calibration
Gauss	1.33 to 1.79	-42 to -69	6	Gives minimal time and frequency errors

Window	Main peak width (bins @ -3dB)	Highest side lobe (dB)	Side lobe roll-off (dB/octave)	Description
Hann	1.20 to 1.86	-23 to -47	12 to 30	Used for audio and vibration work
Hamming	1.30	-41.9	6	Also called raised sine-squared; used for speech analysis
Triangle	1.28	-27	12	Also called Bartlett window

- **Display mode:** The Magnitude Mode displays the frequency spectrum of the last waveform.
- **Scale:** the scaling of the vertical axis.
Logarithm: the vertical axis is scaled in decibels.
- **Logarithm unit:** the reference quantity used for the logarithm scale.

Logarithm Unit	Description
dBV	Reference level is 1V.
dBu	Reference level is 1mW with a load resistance of 600Ω.
dBm	Reference level is 1mW into the specified load impedance.
Any dB	Reference level is an arbitrary voltage.

- **X Scale:** the scale of the frequency axis.
Linear: the axis is scaled in equal intervals from DC to the frequency.

➤ To set the Spectrum View

1. Tap the **Settings** button in the top navigation bar. A dialog box opens
2. Select the **Mode** option in the dialog box, and then tap to select **Spectrum View**.
3. Tap the input field or the dropdown arrow icon to select the desired options from the column. Tap "**OK**" to confirm.

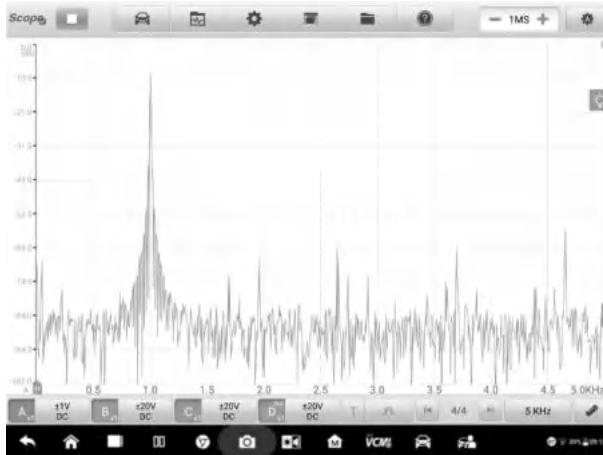

Figure 7-18 Sample Spectrum View Setting Screen 2

Math Channels

A math channel is a virtual channel generated by a mathematical function of the input channel. It can be displayed in an oscilloscope in the same way as an input signal, and like an input signal it has its own measure axis, scale and color.

The oscilloscope has a set of built-in m

- **Turnover:** reverses the signal polarity to turn the waveform upside down on the screen
- **A+B:** channel A plus channel B
- **A-B:** channel A minus channel B
- **A*B:** multiply channel A by channel B
- **A/B:** channel A divided by channel B
- **Frequency:** the frequency of the signal
- **Pulse Width (+):** the positive pulse width
- **Pulse Width (-):** the negative pulse width
- **Duty Cycle (+):** the positive duty cycle
- **Duty Cycle (-):** the negative duty cycle



NOTE

When connecting via Wi-Fi, it only supports Turnover, A+B, A-B, A*B and A/B.

- **To set the math channel**

Using **Invert A** as an example.

1. Tap **Settings** button in the top navigation bar. A dialog box opens.
2. Select the **Math Channels** option in the dialog box.
3. To select the **Invert A**, tap the check box.



Figure 7-19 Sample Math Channel Setting Screen 1

4. Close the dialog box, the waveforms are displayed on the screen.

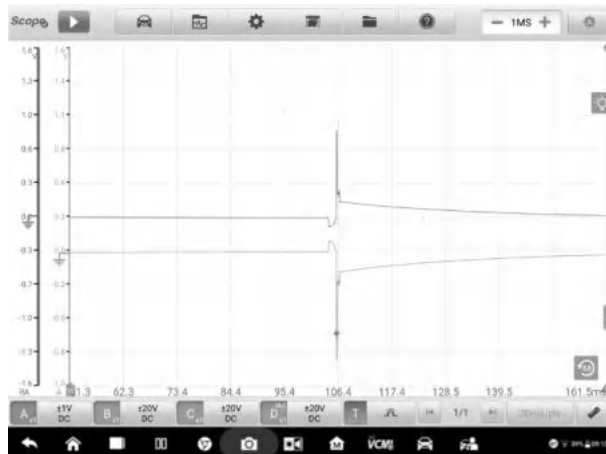

Figure 7-20 Sample Math Channel Setting Screen 2

Waveform Generator Settings

The waveform generator operates simultaneously with the oscilloscope. Use the waveform generator to simulate the DC voltage, square wave, square wave (X+Y), triangle wave, and actuators drive.



Figure 7-21 Sample Waveform Generator Setting Screen

➤ To set the waveform generator

1. Tap the **Settings** button in the top navigation bar. A dialog box opens.
2. Select the **Waveform Generator** option in the dialog box.
3. Swipe the **OFF** to **ON** to enable the waveform generator. Select a desired option from the dropdown menu. Tap the "+" or "-" buttons to adjust the voltage, frequency and duty cycle values.



Figure 7-22 Sample Waveform generator Settings Screen

4. Close the dialog box. The waveform generator settings are displayed on the screen.

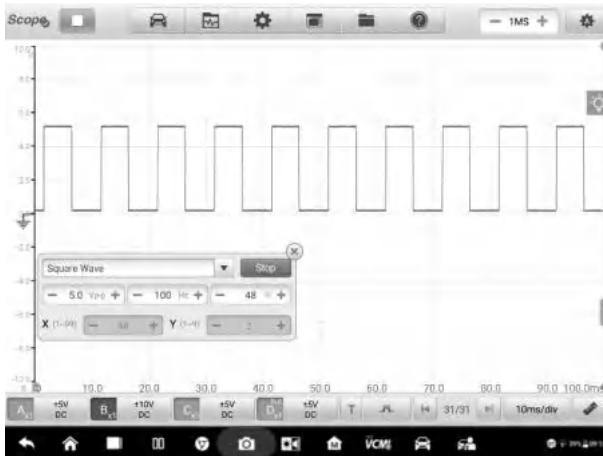

Figure 7-23 Sample Waveform generator Display Screen

Decoding Settings

When the oscilloscope mode is selected, the decoding settings are available. Up to 8 different protocols are supported in the decoding settings.



Figure 7-24 Sample Decoding Settings Screen 1

8 protocols are available: CAN FD, CAN High/CAN Low, LIN, FlexRay, RS232/UART, I2S, I2C, and USB (1.0/1.1). The detailed setting options vary according to each protocol.

- ✧ **CAN FD:** The CAN FD serial protocol is an extended version of the Controller Area Network (CAN), which allows electronic controllers to receive sensor messages and transmits control messages faster than traditional CAN communication.
- ✧ **CAN High / CAN Low:** Controller Area Network (CAN) is a serial protocol used in automotive to allow microcontrollers to communicate with each other. It typically uses differential signaling (with signals named CAN High and CAN Low) to increase noise immunity.
- ✧ **LIN:** Local Interconnect Network (LIN) is a serial protocol used in automotive electronics to allow microcontrollers to communicate with low-speed peripherals.
- ✧ **FlexRay:** It is an automotive network communications protocol for high-speed data.

- ✧ **RS232/UART:** Universal Asynchronous Receiver/Transmitter (UART) is the communication interface found in the serial or COM ports once commonly found on computers. Each channel of data is transmitted on a single wire pair using an electrical standard such as RS232.
- ✧ **I2S:** Inter-IC Sound (I2S) is a serial protocol used in digital audio devices for communications between circuits such as CD transports and audio DACs.
- ✧ **I2C:** Inter-Integrated Circuit (I2C) is a way to connect peripheral chips in consumer electronics products and is widely used in embedded systems.
- ✧ **USB (1.0/1.1):** Universal Serial Bus (USB) is widely used in personal computers and tablets for communication.

Baud Rate: The baud rate will display a default value, which needs to be manually set according to the actual signal to get the correct decoding result.

Threshold: The voltage that defines the transition in either direction between high logic state and low logic state.

Name: The name of the protocol that you have selected above. The channel and the corresponding protocol name will display in the scope view after selection.

Display Setting: You can also choose a display mode for the decoded data: Hex or Binary.

➤ **To make the decoding settings**

Using **CAN High** as an example.

1. Tap the **Settings** button in the top navigation bar. A dialog box opens.
2. Select the **Mode** option in the dialog box and tap the **Oscilloscope Mode**.
3. Select the **Decoding Setting** in the dialog box.
4. Select the channel(s) that you want to set, and then select the "**CAN High**" protocol from the dropdown list.

5. For the baud rate and threshold, you can keep the displayed values or manually enter a value according to the actual signal.
6. Select the **Hex or Binary** display mode from the dropdown list.
7. Tap "OK" to confirm. The decoding settings are displayed on the screen.

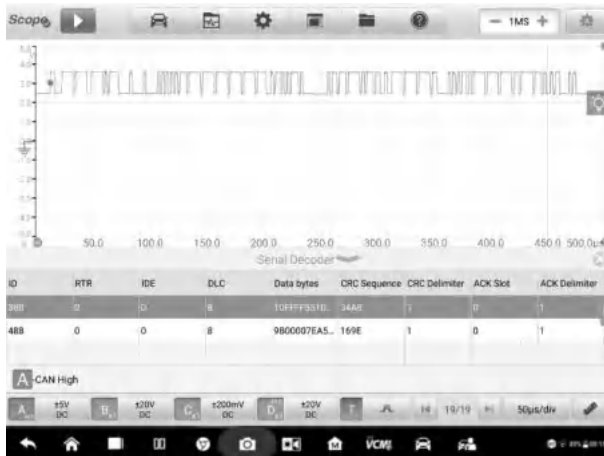

Figure 7-25 Sample Decoding Settings Screen 2

Startup Settings

This function allows the user to choose the startup configuration when launch the oscilloscope application.

On the Startup Settings screen, there are three options: **Load the user default configuration at startup**, **Load the previous session configuration at startup**, and **Load the factory configuration at startup**. Select one option according to the specific need.

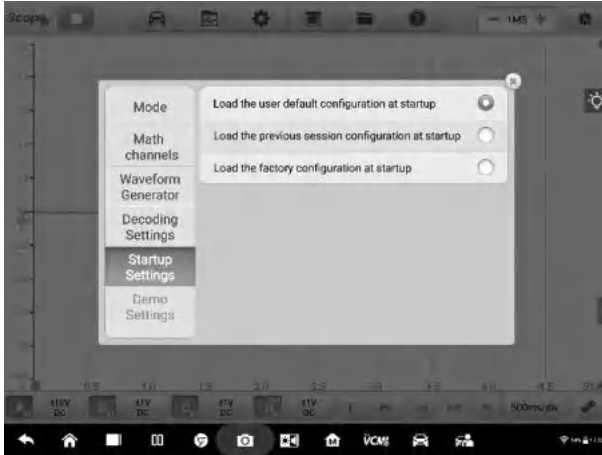

Figure 7-26 Sample Startup Settings Screen

Demo Settings

This function allows the user select the demo waveform for each channel in Demo mode. Select one demo waveform from **Nozzle voltage**, **Nozzle current**, **Ignition signal**, **Sinusoidal signal**, **Square signal** and **signal of the crankshaft**. The rotating speed can be set by tapping the "-" or "+" icon to adjust the value. Tap **OK** to confirm the settings.



Figure 7-27 Sample Demo Settings Screen

Window Display Menu

A display window with grid displays the data captured by the oscilloscope. By default, a single trace is displayed. Additional traces can be added via the window display menu.

Display Mode

The Window Display menu allows you to configure up to four traces.

Single Window – displays a single trace.

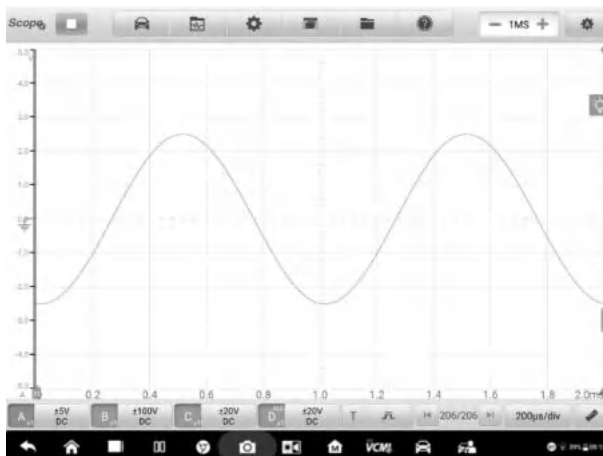

Figure 7-28 Sample Single Window Screen

Double Window – displays two separate traces horizontally, one below the other.

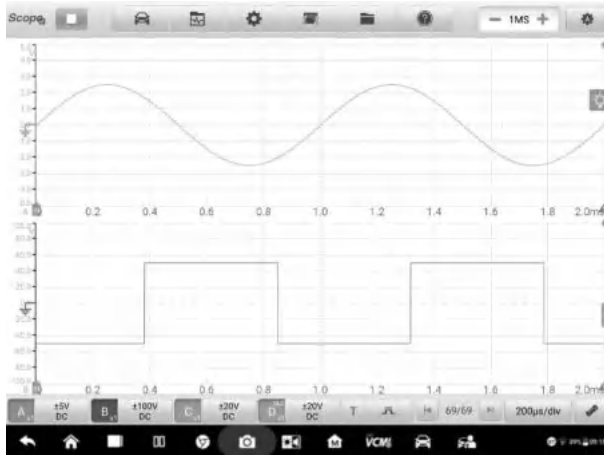

Figure 7-29 Sample Double Window Screen

Triple Window – displays three separate traces horizontally, one below the other.

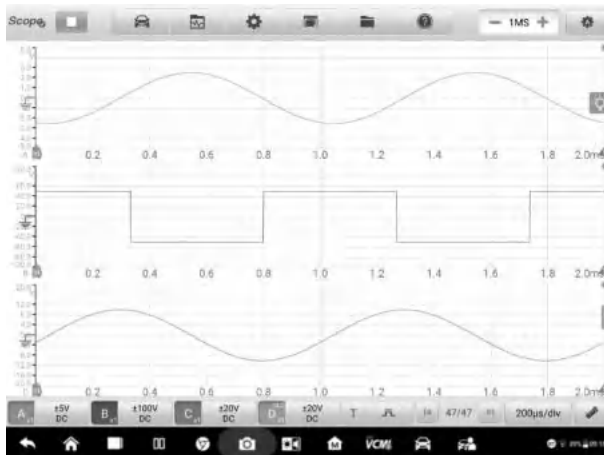

Figure 7-30 Sample Triple Window Screen

Quadruple Window – displays four separate traces, two horizontally, two vertically.

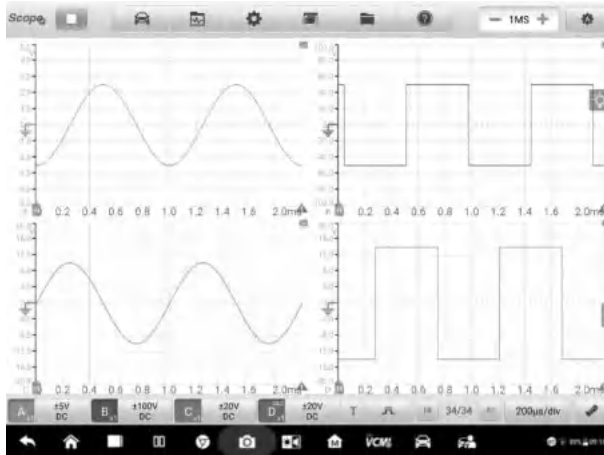

Figure 7-31 Sample Quadruple Windows Screen

➤ **To set the display mode**

1. Tap the **Window Display** button in the top navigation bar. A dialog box opens.
2. Select the **Display Mode** in the dialog box.
3. Tap the appropriate number icon to display the corresponding number of traces onscreen.



Figure 7-32 Sample Display Mode Selection Screen

4. Close the dialog box. The window is displayed as selected.

Channel Settings

The channel settings allow you to arrange the display position of the activated channels. Select which channels are visible in the display window. The display status is set to **ON**, the input channels are enabled, otherwise, the input channels (set to OFF status) are not available for viewing.

➤ To set the channel setting

1. Tap the **Window Display** button in the top navigation bar. A dialog box opens.
2. Select the **Channel Settings** in the dialog box.
3. Swipe the display status icon to **ON**. Select the position for each channel from the dropdown menu.

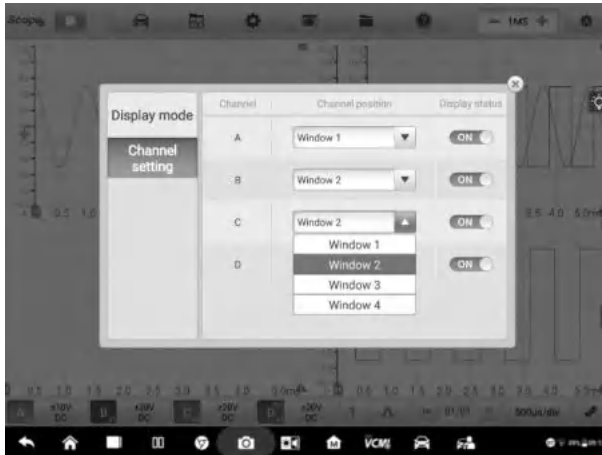

Figure 7-33 Sample Channel Setting Screen

4. Close the dialog box and the activated channel is displayed in the selected window.

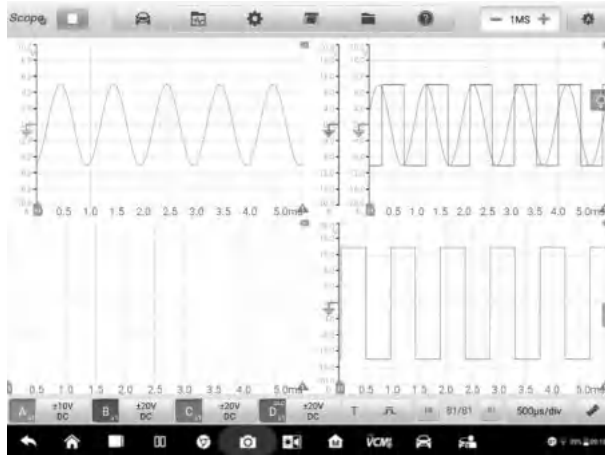

Figure 7-34 Sample Channel Display Screen

File Menu

The **File** menu allows you to print, open, save, and delete the waveform data. The **File Menu** supports the following functions.

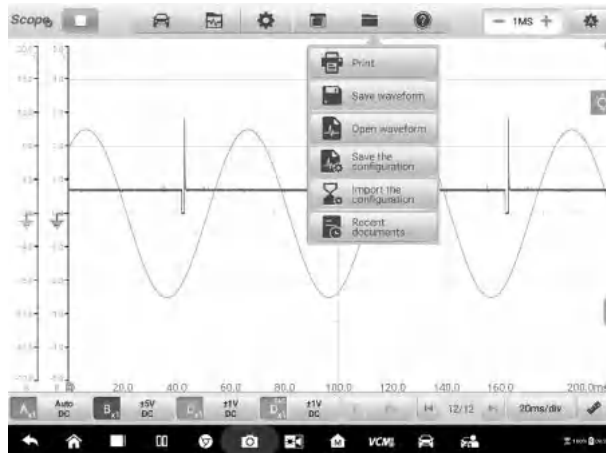

Figure 7-35 Sample File Menu Screen

- **Print** – Tap to create and print a temporary PNG picture of the current waveforms.

NOTE

-
1. Make sure the tablet is properly setup to print and is connected to the printer.
 2. Make sure the network is available.
-

- **Waveform Operation**

This section allows you to save and open the waveforms.

Save waveform – Tap to save the waveform on the current screen. Three types of file saving are available in the dropdown list: **the default oscilloscope data file**, **the normal text file**, and **the Excel file**. Select one of the file saving ranges from **save current page**, **save last 5 pages** and **save all pages**. Finally tap the "Save" button to save the waveform.

Select the Normal Text File option to save the current waveform data to a text file. Use the ES File Explorer app on the Android home screen to review file: **Home > ES File Explorer > Local > Internal Storage > Scan > Data > Scope > txt**.

Open waveform – Tap to retrieve the saved waveforms.

- **Configuration Operation**

The configurations can be saved and imported, or set to default.

Save the configuration – Tap to save the configuration values of waveforms on the current screen including the amplitude, the time base, the number of samples, etc.

Import the configuration – Tap to import the saved configuration values of waveforms. Tap the System Default Configuration option to cancel the current setting values and refresh the screen to retrieve the default setting values.

- **Recent documents** – Tap to open the recent documents in order to view the waveforms currently opened in the waveform library.

Help Menu

The Help Menu displays the user manual, update the APK and firmware, and view version numbers of the installed APK and firmware.

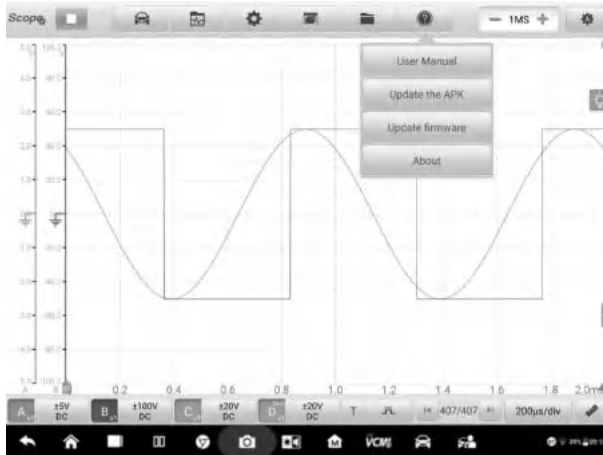

Figure 7-36 Sample Help Menu Screen

User Manual – displays instruction for the proper use of the oscilloscope.

Update the APK – connects to the Autel server and to get the latest application software version.

Update Firmware – connects to the Autel server and to get the latest firmware version.

About – displays the model number and the installed versions of the software and firmware.

Number of Samples

This button allows you to set the maximum number of samples that will be captured by each channel. The sampling rate of current time base can be adjusted by changing the number of samples. Review the sampling interval, sampling rate, and sample size in the [Parameter and Help](#) sheet.

Tap the minus or plus icon to adjust the number of samples.

Auto Scale

Use the **Auto Scale** button to trigger the device to automatically analyze the signal of the opened channel, and automatically set the appropriate amplitude and time base range to display the signal correctly. In auto scale setting, the time base is only valid for periodic signals.

7.1.5.2 Main View Section

Up to four traces, along with digital readouts of current signal values, signal status and triggering conditions, can be displayed simultaneously on the main view section screen.

Each trace has two control features, **X-axis** and **Y-axis**, which enable you to adjust the oscilloscope settings to suit the particular test measurement. If multiple traces are displayed at the same time, the **Y-axis** for each trace is adjusted separately while the **X-axis** is the same for all traces.

- **Y-axis** – the voltage level is recorded on the vertical. It displays on the left side of the screen.
- **X-axis** – time is presented on the horizontal line. It is shown along the bottom of the screen.

Measurement Overrange Indicator

When the amplitude exceeds the measurement input range, a **red overrange indicator** with the message "overrange" is displayed in the top left corner of the screen. Exceeding the common-mode input range may result in inaccurate measurements and can lead to severe signal distortion.

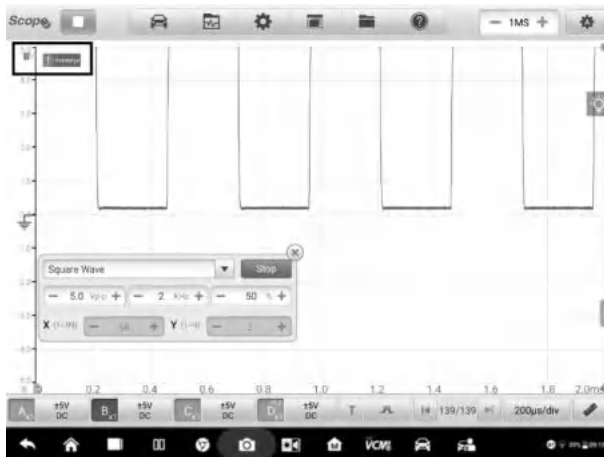

Figure 7-37 Sample Overrange Indicator Screen

Select an appropriate scale setting for the signal being sampled to avoid an overrange condition.

! IMPORTANT

To prevent electric shock, do not exceed voltage limits between inputs.

Channel Selection

In the main view section, a channel has two conditions: selected and unselected. A channel must be selected in order for the waveform to be movement, to use the zoom-in or to add measurement rulers.

Tap the zero baseline marker or the Y-axis (the line thickens when selected). After the channel is selected, the waveform can be zoomed. Tap the counterclockwise arrow button at the right corner to recover after zoomed.

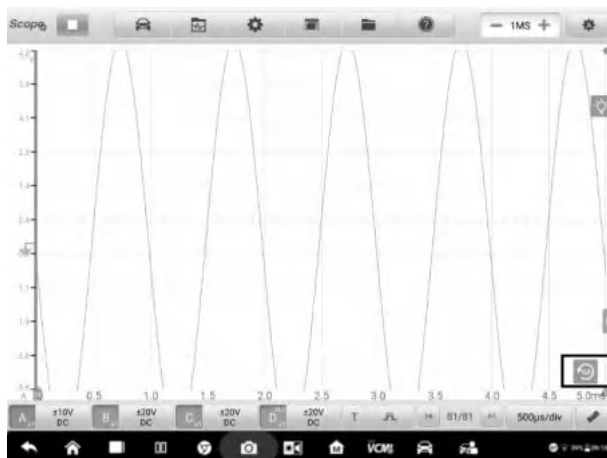

Figure 7-38 Sample Channel Selection 1 (Selected)

Tap the zero baseline marker or the Y-axis again to exit the channel selection.

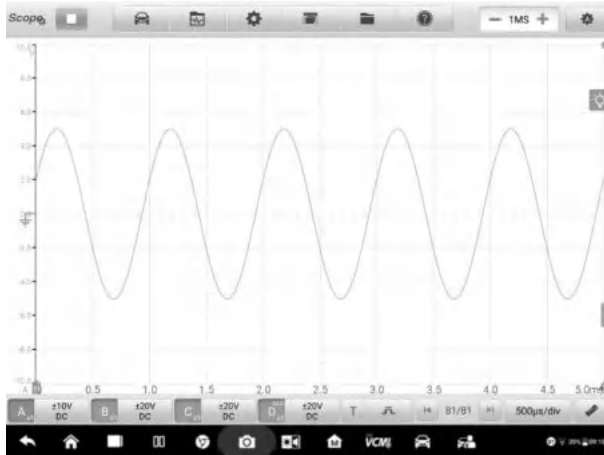

Figure 7-39 Sample Channel Selection 1 (Unselected)

Waveform Zooming

The zooming function allows you to change the size and position of a signal during or after capturing a waveform to examine it in greater details. It does not change the stored data, but the way it displays.

The X-axis and Y-axis can be zoomed using your fingertips. The waveform can be zoomed during or after capturing the signal.

Measurement Rulers

The coordinate Rulers allow the amplitude and time duration of a waveform to be measured precisely. They are useful when determining signal characteristics such as amplitude at specific points, the cycle time (duration) and frequency.

There are three types of measurement rulers: the vertical **Time Ruler**, the horizontal **Signal Ruler**, and the vertical **Angle Ruler**.

Tap the **Ruler Activator** in the lower left corner of the grid and drag it across the screen to the desired position. A **Time Ruler** is generated.

Tap the **Ruler Activator** in the lower right corner of the grid and drag it across the screen to the desired position. An **Angle Ruler** is generated.

The two angle rulers are positioned to mark the start and end of a cycle. By default, the start and end angle values are 0° and 720°, which can be configured in the Phase Setting box.

The **Signal Ruler** can be generated in the similar way by tapping the **Ruler Activator** in the upper right corner and dragging it downwards.

When dragging the Measurement Rulers, a **Ruler Table** showing time and voltage values for the corresponding channels will be displayed. The **Delta** icon refers to the absolute difference between the values of the rulers, which can be locked by tapping the **Lock** icon. Tap the **X** button in the upper right corner of the ruler table to delete all rulers.

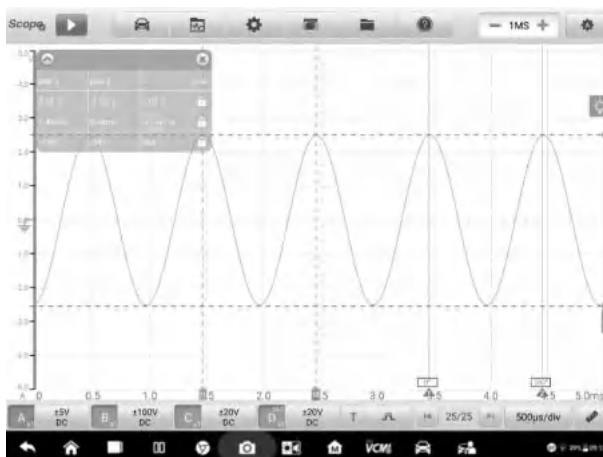

Figure 7-40 Sample Rulers Display Screen

➤ **To configure angle settings**

1. Drag **Angle Activator** to generate the angle rulers.
2. Tap the start or end angle value to open the Phase Setting box.
3. Input the desired phase value and the ruler value in the field.



Figure 7-41 Sample Phase Setting Screen

4. Tap **Confirm** in the upper right corner to save the settings, or tap **Cancel** to exit without saving.

Zero Baseline

The zero baseline is marked the 0 value in the Y-axis, showing the ground level of each channel waveform.

After the channel is selected, the Zero Baseline can be adjusted by dragging the zero baseline marker up/down along the Y-axis, or dragging the waveform up/down, or moving the screen up/down in the grid.

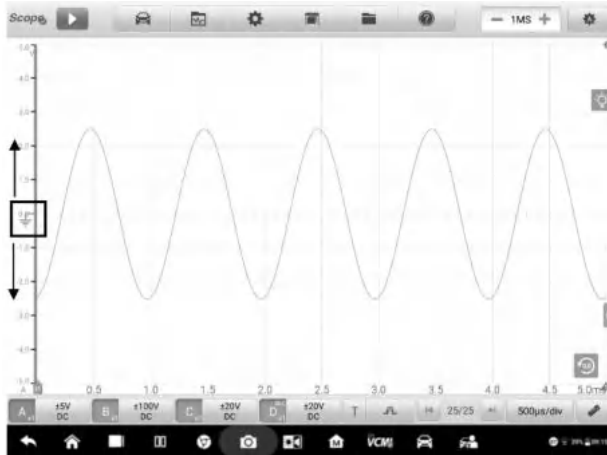

Figure 7-42 Sample Dragging Zero Baseline Marker Screen

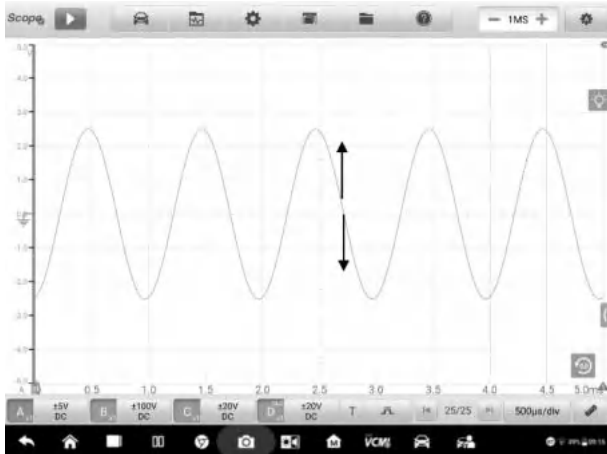

Figure 7-43 Sample Dragging Waveform or Moving Screen



NOTE

To reposition waveform or to move the screen, tap the zero baseline marker to select. The line will display thicker when selected.

Parameter and Help

Tap the arrow button in the lower right corner of the screen to open the Parameter and Help windows.

The **Parameter** function allows you to view the values of parameters including sampling interval, sampling rate, sample size, channel, range and coupling mode.

The **Help** function displays the user manual of the oscilloscope. The Help page also displays when selecting the Help and User Manual buttons on the upper toolbar. The help information can be full-page shown by tapping the four-directional arrow icon in the lower right corner.

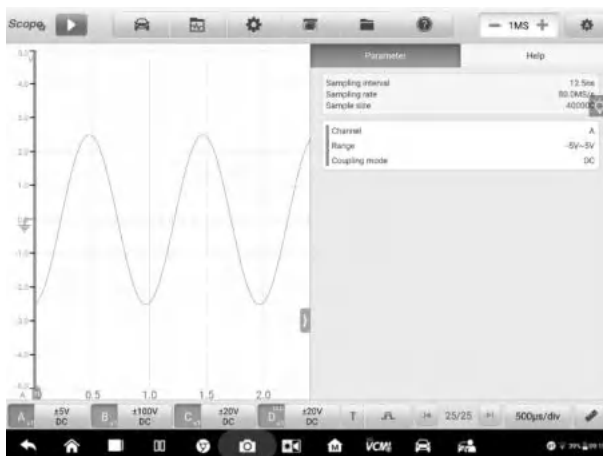

Figure 7-44 Sample Parameter Screen

➤ **To open or close the parameter and help window**

1. Tap the arrow button on the right-hand side of the screen.

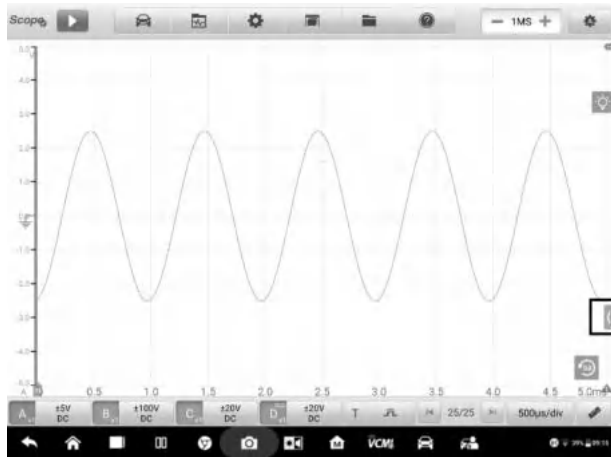

Figure 7-45 Arrow Button Position Screen

2. The parameter and help window displays.
3. To close, tap the arrow button again or tap any space outside of the window.

Note

The preset guided information is also displayed on the right side of the screen when the specific options and test components have been selected from the Presets menu.

Real-time Help

The real-time help button is a bulb-shaped button that can be dragged and moved on the screen.

Tap this real-time help button to directly switch to display all the relevant introduction and test procedure information after you tap any function on the oscilloscope screen, for better understanding the selected function.

➤ **To view the real-time help information**

Take the Presets function as an example.

1. Tap the **Presets** button on the upper toolbar to open the preset menu.
2. Tap the bulb-shaped real-time help button. All the information about the presets menu is displayed on right side of the screen.

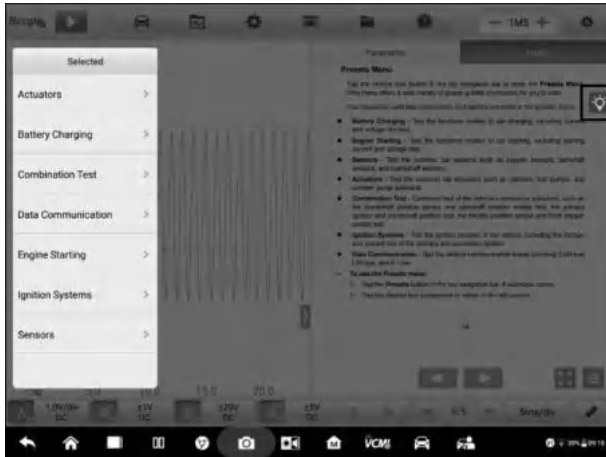

Figure 7-46 Sample Real-time Help Screen 1

3. View the information by dragging it up and down using your fingertips.

The real-time help information can be displayed in a full screen by tapping the four-directional arrow icon in the lower right corner. Tap it again to recover the half-screen display.

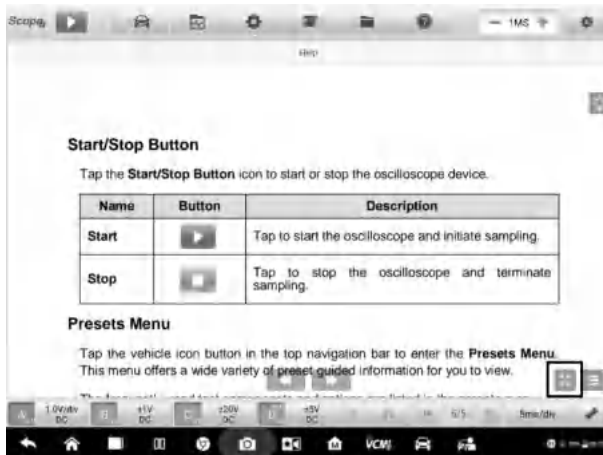

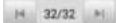



Figure 7-47 Sample Real-time Help Screen 2 (Full Screen)

7.1.5.3 Lower Toolbar

The buttons in the lower toolbar include the channel control buttons, trigger setting buttons, buffer button, time base button and measurement button. The following table provides brief description of each button.

Table 7-4 Lower Toolbar

Name	Button	Description
Channel Control		Tap to configure the settings of each channel. Active channel icons display in color; inactive icons display in gray. See Channel Control on page 139 for more information.
Trigger		Tap to open the trigger setting menu. See Trigger on page 150 for more information.
Buffer		Tap the Back or Next button to scroll to the previous or the next frame in the waveform. See Buffer on page 160 for more information.
Time Base		Tap to select an appropriate time per division. See Time Base on page 161 for more information.
Measurement		Tap to select an appropriate measurement. See Measurement on page 163 for more information.

Channel Control

There are four input channels: **input channel A**, **input channel B**, **input channel C**, and **input channel D**. The four channel buttons display on the lower left side of the screen. Set the input channel(s) through the corresponding channel control button(s).

Each **Channel Control** button includes channel on/off, amplitude setting, and probe setting. The probe name is displayed in the lower right corner of the left column of the channel control button. The amplitude is displayed in the right column of the channel control button.

➤ To activate and close the channel

1. Tap the left column of the channel control button to activate the channel. The button color changes from gray to the corresponding color of the channel.

2. Tap the right column of the channel control button to open the settings dialog box.

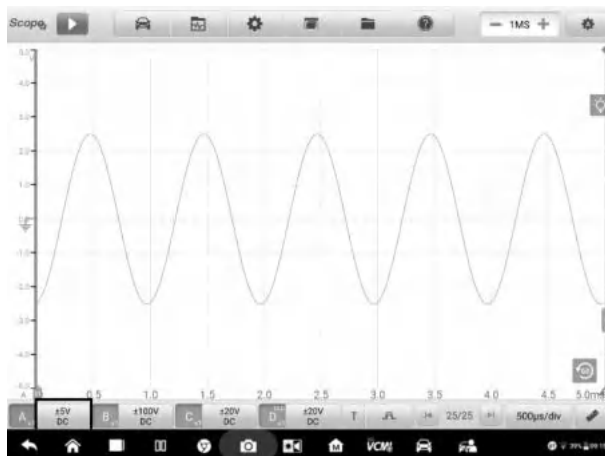

Figure 7-48 Sample Activate Channel Screen

3. Tap the left column of channel control button again to close the channel. The closed channel button displays gray.

Channel Color

Identify each channel waveform by color.

Table 7-5 Channel Color Table

Input Channel	Color
A	Red
B	Green
C	Blue
D	Yellow

Amplitude Settings

The amplitude, probe, low-pass filtering and DLC channel settings can be configured in the Channel control dialog box.

The amplitude settings allow you to set up the oscilloscope to capture signals with the specified range. If the input signal exceeds the selected range, an over-range

indicator will be displayed. Select **Auto** to enable the device to adjust the vertical scale automatically.

It changes the vertical scale, while the horizontal scale is not changed. AC and DC voltage can be toggled to set up the input circuitry.

Note

The vertical scale is ALWAYS divided into 10 major divisions, and all scale settings reflect in these 10 divisions. The division set of 10 cannot be changed.

There are two modes available to set the amplitude value.

Mode 1: For example, selecting **DC 5V** sets the channel amplitude to ± 5 DC (displayed on the right side of the channel control button), the vertical scale range is from -5V to +5V. The vertical scale is divided into 10 segments, each segment increases by 1V.



Figure 7-49 Sample Amplitude Setting Screen (DC 5V)

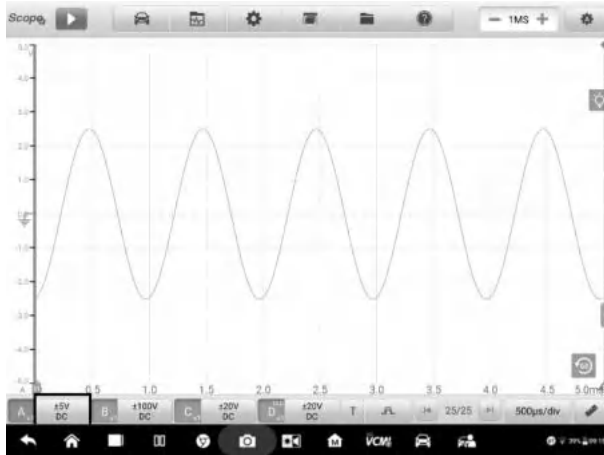

Figure 7-50 Sample Amplitude Setting Screen (DC 5V)

Mode 2: Select the **## /div** button to adjust value incremented by each division. For example, selecting **DC 1.0V/div**, sets the channel amplitude to 1.0V/div DC (seen at the right side of the channel control button). Each segment increases by 1V. As the vertical scale is divided into 10 segments, the entire vertical scale range is from -5V to +5V.



Figure 7-51 Sample Amplitude Setting Screen (DC 1.0V/div)

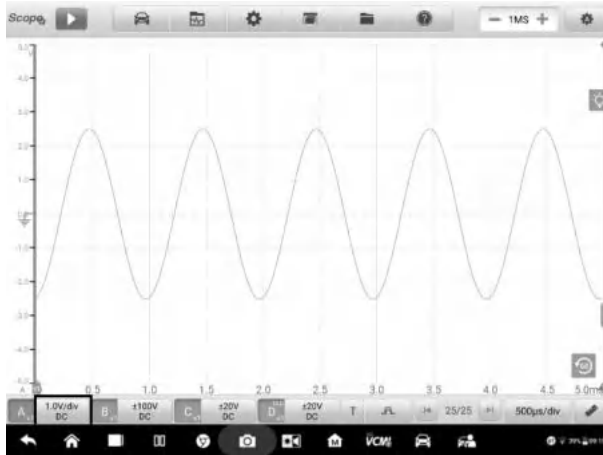

Figure 7-52 Sample Amplitude Setting Screen (DC 1.0V/div)

Probe Settings

A probe is an accessory that connects to your oscilloscope and to detect signals to be measured.

This oscilloscope has built-in definitions of standard probes. By default, the probe is set to be x1, which means 1V signal at the input to the probe will display as 1V.

The inner probes (built-in probes) include:

- **X1:** no attenuation
- **10 : 1 Attenuator:** select when using a 10-fold attenuation probe
- **20 : 1 Attenuator:** select when using a 20-fold attenuation probe (SA020)
- **X1000:** select when using a 1,000-fold attenuation probe
- **65A Current Clamp (1mV/10mA mode, Max: 20A):** 1mV/10mA mode on 65A current clamp, the max. current is 20A
- **65A Current Clamp (1mV/100mA mode, Max: 65A):** 1mV/100mA mode on 65A current clamp, the max. current is 65A
- **650A Current Clamp (1mV/100mA mode, Max: 200A):** 1mV/100mA mode on 650A current clamp, the max. current is 200A
- **650A Current Clamp (1mV/1A mode, Max: 650A):** 1mV/1A mode on 650A current clamp, the max. current is 650A
- **Coil-On-Plug Ignition Probe [COP]:** select when using the COP ignition probe (SA271)

- **Secondary Ignition Probe [ignition]:** select when using the secondary ignition probe (SA273)
- **Secondary Ignition Probe (inverted) [R_ignition]:** select when using the secondary ignition probe (SA273) and inverting the secondary ignition signal

You can select the inner standard probes in the probe settings. After selecting a correct probe, the settings can be seen in the lower right corner of the left column of the channel control button, indicating the probe is in use.

Tap the question mark icon to view the image of the corresponding current clamp in full screen.



Figure 7-53 Sample Inner Probe Setting Screen

Probe Edit

Add custom probes not included in the built-in standard probe menu.

NOTE Please refer to the probe's instruction manual or consult the corresponding manufacturer for the linear equation ($y=mx+c$).



Figure 7-54 Sample Probe Edit Screen 1

➤ **To add custom probes**

Add a 20 : 1 Attenuator as an example:

1. Tap the right column of the channel control button at the bottom of the screen to open the setting dialog box.
2. Select the **Probe Edit** option in the left column of the dialog box.
3. Tap each field to open the virtual keyboard and input the required information.

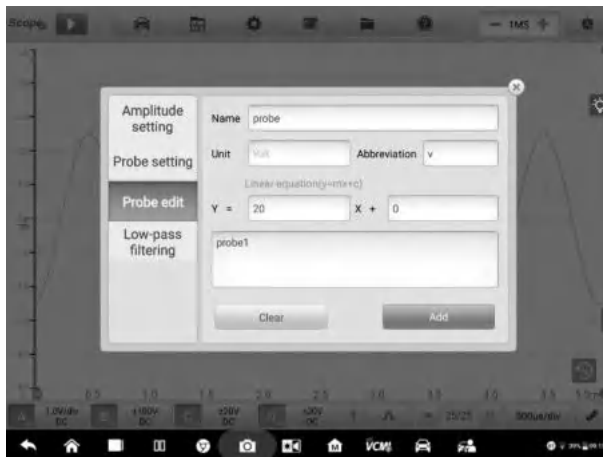

Figure 7-55 Sample Probe Edit Screen 2

4. Tap **Add** to save the settings, or tap **Clear** to exit without saving.
5. The added probe will be listed in the Probe Settings window.

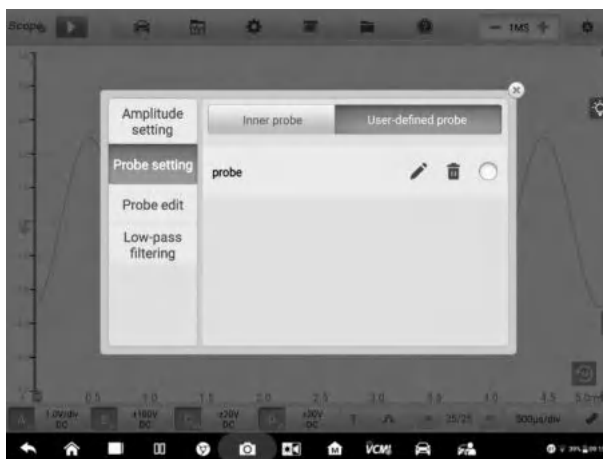

Figure 7-56 Sample Probe Edit Screen 3

LPF (Low-pass Filtering)

The low-pass filtering (LPF) is an independent digital low-pass filter for each input channel used to remove noise from the signal.

This function is used to filter the high frequency signal of the selected input channel for more accurate measurements. Take the two screenshots below as an example to show the comparison with or without setting the low-pass filtering. The following screenshots show the difference between waveforms with the low-pass filtering and waveforms without the low-pass filtering.

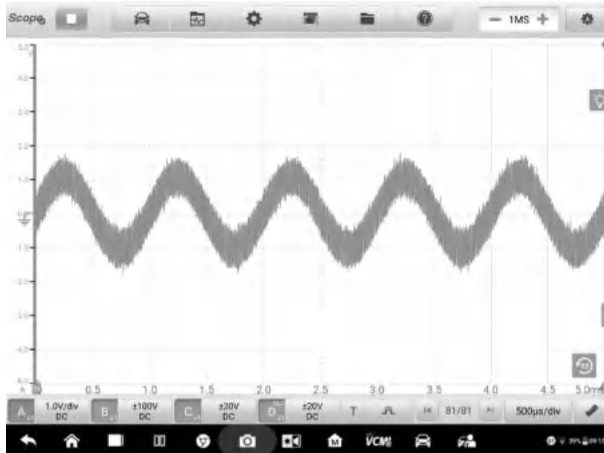

Figure 7-57 Before Setting Low-pass Filtering Screen

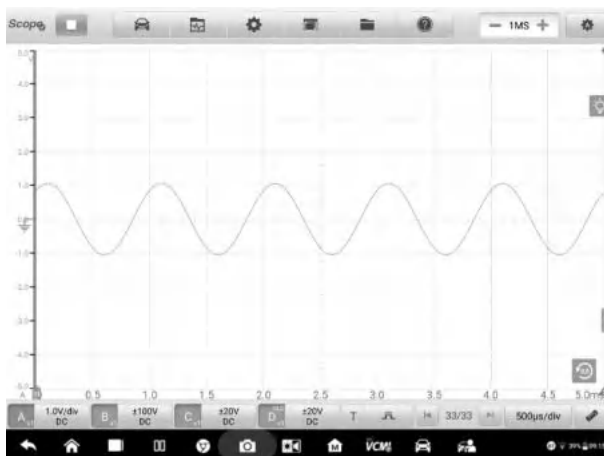

Figure 7-58 After Setting Low-pass Filtering Screen

➤ **To configure the low-pass filtering settings**

1. Tap the right column of the channel control button to open the setting dialog box.
2. Select the **Low-pass Filtering** option from the left column of the dialog box.
3. Tap the checkbox of the appropriate channel and adjust frequency by tapping the minus or plus. The unit can be switched to **Hz**, **KHz** or **MHz** from the dropdown list.

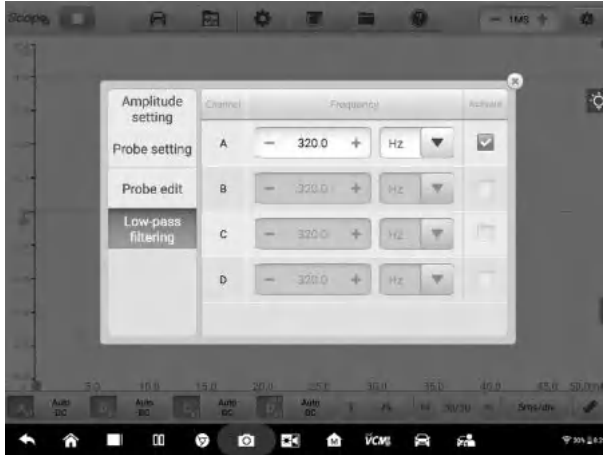

Figure 7-59 Sample Low-pass Filtering Screen

4. Close the dialog box directly to exit without saving.

DLC Channel

The DLC (Data Link Connector) channel enables data to be collected from the vehicle's OBDII pins for analysis of vehicle communications. The DLC channel icon displays on the **input channel D** button.

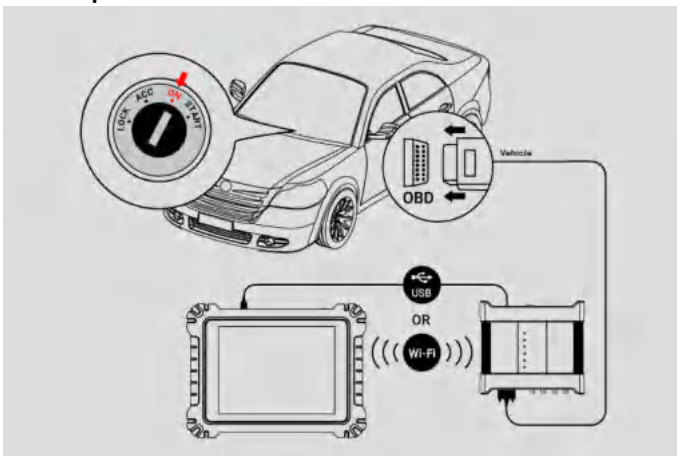

Figure 7-60 Sample DLC Connection Diagram

- To open and set the DLC channel

1. Tap the right column of the channel D button at the bottom of the screen to open the setting dialog box.
2. Select the **DLC Channel** in the left column of the dialog box.
3. Swipe the **Enable DLC channel** to **ON**. Select the appropriate pins.

NOTE

If the Enable DLC channel button **CAN NOT** be swiped to **ON**, please remember to connect the VCMII power adapter and keep it charging.



Figure 7-61 Sample DLC Channel Setting Screen 1

4. Close the dialog box, the selected result is displayed on the screen. Tap the amplitude setting button at the bottom of the screen to adjust the value for the DLC channel.



Figure 7-62 Sample DLC Channel Setting Screen 2

5. Swipe the **Enable DLC** channel to OFF to close the DLC channel and switch to the oscilloscope function.



Figure 7-63 Sample DLC Channel Setting Screen 3

Trigger

The trigger feature is used to filter and capture specified waveform data.

According to the trigger setting condition, the trigger waveform will be captured when the signal meets the trigger condition. When capturing waveforms, you can manually set the trigger conditions.

When the oscilloscope is capturing the signal, tap the left column of the **Trigger** button to activate the trigger function. A **trigger point** displays as a blue point.

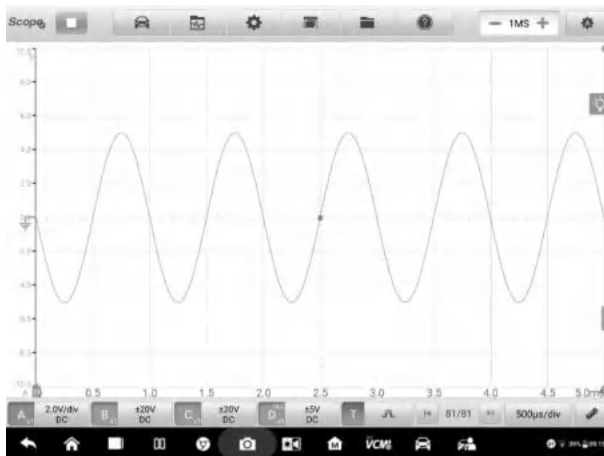

Figure 7-64 Sample Trigger Point Screen

When the oscilloscope is capturing the signal, tap the right column of the **Trigger** button to open the trigger settings dialog box.



Figure 7-65 Sample Trigger Settings Screen

Edge Triggering

The edge trigger is one of the most common trigger modes and is activated when voltage rises above or falls below a preset threshold. This trigger type allows you to configure the trigger mode, threshold, trigger channel and pulse direction settings. Tap **Done** to save the settings or tap **Cancel** to exit without saving.



NOTE

The oscilloscope switches to the continuous mode if the time base is set to more than or equal to 200ms/div. The Edge Triggering is supported in the continuous mode.

- **Trigger Mode**

Four trigger modes are available: **None, Auto, Repeat and Single.**



Figure 7-66 Sample Trigger Mode Screen

The table below offers brief descriptions for each trigger mode.

Table 7-6 Trigger Mode Table

Trigger Mode	Description
None	In this trigger mode, the oscilloscope can continuously capture data, without waiting for a trigger event.

Trigger Mode	Description
Auto	In this trigger mode, the oscilloscope will wait for a trigger before capturing data. It can automatically update after a short period, even if the signal does not across the trigger point.
Repeat	In this trigger mode, the oscilloscope waits until a trigger event occurs. If there is no trigger event, nothing will be displayed on the screen.
Single	In this trigger mode, the oscilloscope stops capturing data once a trigger event occurs.

- **Channel**

Select the applicable trigger channel from the dropdown menu. The selected channel is the one that the oscilloscope monitors for the trigger condition.



Figure 7-67 Sample Trigger Channel Screen

- **Pulse Direction**

Two pulse direction settings are available: **Rise** and **Fall**.



Figure 7-68 Sample Pulse Direction Screen

- ✧ **Rise Edge Trigger** - Indicates trigger is turned on to start the trace on the rising edge of the waveform.
- ✧ **Fall Edge Trigger** – Indicates trigger is turned on to start the trace on the falling edge of the waveform
- **Threshold**

The **Threshold** allows you to set the voltage threshold for the trigger.

- ✧ To precisely position the trigger point, input the value in the Threshold field in the trigger settings dialog box.
- ✧ To roughly position the trigger point, drag the trigger point to a desired position.
- **To configure the trigger settings**

1. Tap the right column of the **Trigger** button to open the trigger settings dialog box.
2. Select the trigger mode, trigger channel and pulse direction in the dropdown list.
3. Input the value in the Threshold field in the trigger settings dialog box.
4. Tap **OK** to save settings or tap **Cancel** to exit without saving.

Advanced Edge

This trigger type includes all the functions of the edge trigger type, plus two additional options: **the Rising or Falling option** and **the hysteresis option**.

Rising or Falling option in the dropdown menu of the pulse direction: Dual edges of a waveform can be triggered. This mode is especially useful for monitoring pulses of both polarities at once.

Hysteresis option: It is used to reduce false triggering on noisy signals. When hysteresis is enabled, a second trigger threshold voltage is used in addition to the main trigger threshold. The trigger fires only when the signal crosses the two thresholds in the correct order. The first threshold arms the trigger, and the second causes it to fire.



Figure 7-69 Sample Advanced Edge Settings Screen

Window

This trigger type is used to monitor when the signal enters or exits a specified voltage window.

Three options are available for the pulse direction: **Entering, Exiting, Entering or Exiting**. The **Threshold 1** and **Threshold 2** are the upper and lower voltage limits of the window.



Figure 7-70 Sample Window Settings Screen

Pulse Width

This trigger type allows you to monitor pulses of a specified width.

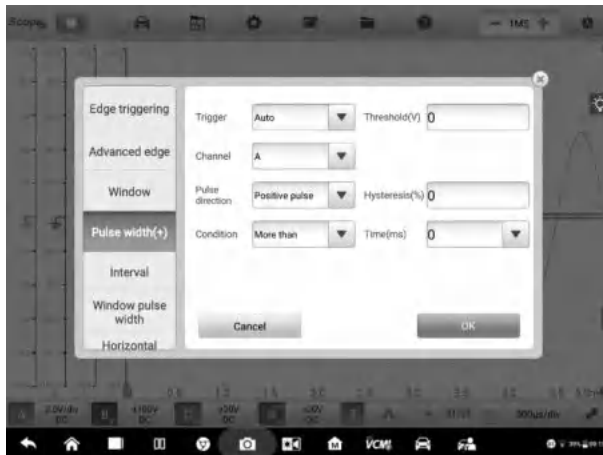

Figure 7-71 Sample Pulse Width Settings Screen

➤ To set the pulse width

1. Tap the **Trigger** button at the bottom of the screen to open the Trigger Settings dialog box.

2. Select the **Pulse Width (+)** in the left column of the dialog box.
3. Select the desired trigger mode and channel mode.
4. Set the pulse direction to either Positive pulse or Negative pulse according to the polarity of the pulse.
5. Select one of the four Conditions:
 - **More than:** triggers on pulses wider than the specified time.
 - **Less than:** triggers on pulses narrower than the specified time.
 - **In the time range:** triggers on pulses wider than Time 1 and narrower than Time 2.
 - **Out of the time range:** triggers on pulses narrower than Time 1 or wider than Time 2.
6. Set the trigger **Threshold** and **Hysteresis**.
7. Set the **Time 1** or **Time 2** in minutes (if available) to define the pulse width.
8. Tap **OK** to save settings or tap **Cancel** to exit without saving.

Interval

This trigger type allows you to search for two consecutive edges of the same polarity separated by a specified time interval.

For the setting operation, please refer to the operation steps of Pulse Width, but the pulse direction with Rise or Fall selection instead of Positive or Negative.



Figure 7-72 Sample Interval Settings Screen

Window Pulse Width

This trigger type combines with the window trigger and the pulse width trigger. It detects when a signal enters or exits an input range and stays for a specified period of time. Two **Region** options can be selected: **In range** and **Out of range**.



Figure 7-73 Sample Window Pulse Width Settings Screen

Horizontal Distortion

This trigger type can be monitored when the signal goes high or low for longer than the specified time.



Figure 7-74 Sample Horizontal Distortion Settings Screen

Window Distortion

This trigger type monitors when a signal enters a specified voltage range and stays within that range for a specified period of time.



Figure 7-75 Sample Window Distortion Settings Screen

Underthrow

This trigger type monitors a pulse that exceeds one threshold and then drops below the threshold without exceeding the second threshold. This type of trigger is typically used to find pulses that do not reach a valid logic level.



Figure 7-76 Sample Underthrow Settings Screen

Buffer

The buffer is used to store the captured waveform data for real-time and playback display.

The oscilloscope can capture and store waveforms. Select a waveform from the waveform buffer by tapping the **Previous** or **Next** button.

The waveform buffer displays the current waveform number and the total number of stored waveforms.

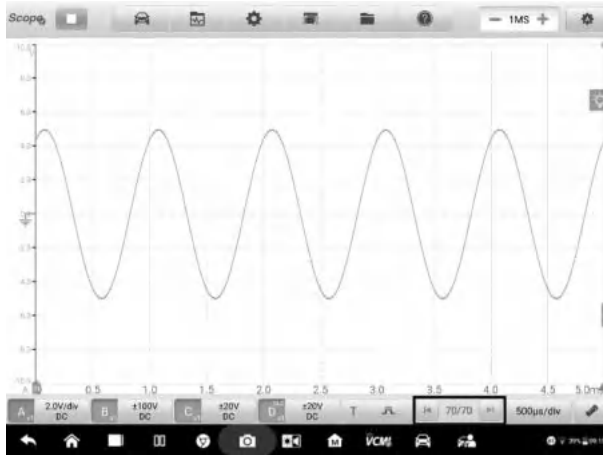





Figure 7-77 Sample Buffer Screen

Name	Button	Description
Previous		Tap to display the previous waveform in the buffer.
Buffer Index		Displays the number of the waveform currently displayed onscreen out of the total number of buffered waveforms.
Next		Tap to display the next waveform in the buffer.

Time Base

The Time Base controls the oscilloscope data sampling display time. Tap the **Time Base** button at the bottom to open the setting dialog box.

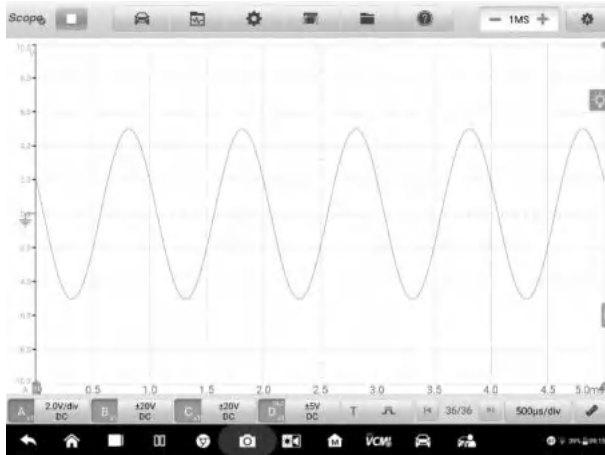

Figure 7-78 Sample Time Base Screen 1 (Normal Mode)

Continuous Mode: if the time base is set to more than or equal to 200ms/div, the oscilloscope switches to the continuous mode. In this mode, the oscilloscope updates the trace continuously as each capture progresses, rather than waiting for a complete capture before updating the trace.

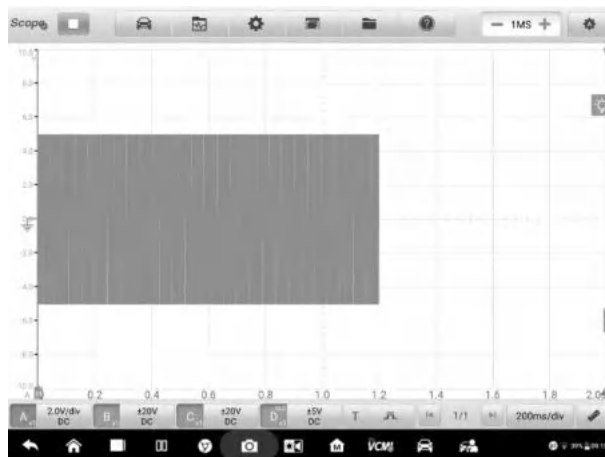

Figure 7-79 Sample Time Base Screen 2 (Continuous Mode)

Measurement

The available measurements for each channel are (from left to right):



Figure 7-80 Sample Measurement Screen 1

- **Maximum** – the highest level that the signal reaches
- **Minimum** – the lowest level that the signal reaches
- **Peak To Peak** – the difference between maximum and minimum
- **Amplitude** – the top value minus the bottom value
- **Period** – the duration of one cycle in a repeated pattern in the waveform
- **Frequency** – the number of signal occurrences per second
- **Positive Duty Ratio** – the ratio of positive pulse width to period width
- **Negative Duty Ratio** – the ratio of negative pulse width to period width
- **Positive Pulse Width** – the amount of time that the signal spends above its average value
- **Negative Pulse Width** – the amount of time that the signal spends below its average value
- **AC RMS** – the root mean square (RMS) value of the waveform minus the DC Average
- **True RMS** – the root mean square (RMS) value of the waveform, including the DC component
- **DC Average** – the average value of the waveform

- **Rising Rate** – the rate at which the signal level rises
- **Falling Rate** – the rate at which the signal level falls
- **Rise Time** – the time the signal takes to rise from the lower threshold to the upper threshold
- **Fall Time** – the time the signal takes to fall from the upper threshold to the lower threshold
- **X@Max** – the corresponding value of X axis when the amplitude is the maximum
- **X@Min** – the corresponding value of X axis when the amplitude is the minimum
- **Positive Acreage** – the waveform acreage measured above the zero baseline
- **Negative Acreage** – the waveform acreage measured below the zero baseline
- **Full Acreage** – the positive acreage plus negative acreage
- **Top Value** – 90% of the waveform maximum value
- **Bottom Value** – 10% of the waveform minimum value
- **Positive Overshoot** – the ratio of the difference between the maximum value and the top value and the amplitude
- **Negative Overshoot** – the ratio of the difference between the bottom value and the minimum value and the amplitude
- **Positive Pre-shoot** – the ratio of the difference between the bottom value and the minimum value and the amplitude
- **Negative Pre-shoot** – the ratio of the difference between the maximum value and the top value and the amplitude



NOTE

When connecting via Wi-Fi, it only supports Maximum, Minimum, Peak To Peak, Amplitude, Period, Frequency, Positive Duty Ratio, Negative Duty Ratio, Positive Pulse Width, Negative Pulse Width, AC RMS, True RMS, DC Average, X@Max, X@Min, Top Value and Bottom Value.

In the **Spectrum View**, the available measurements are as follows.

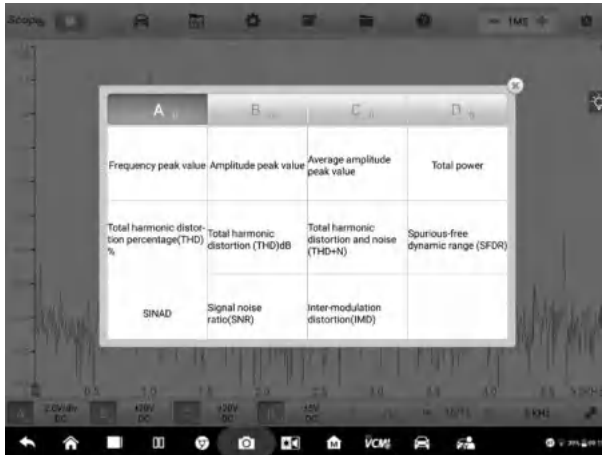

Figure 7-81 Sample Measurement Screen 2 (Spectrum View)

- **Frequency Peak Value** – the frequency of the peak signal value
- **Amplitude Peak Value** – the amplitude of the peak signal value
- **Average Amplitude Peak Value** – the amplitude of the peak signal value captured over multiple times
- **Total Power** – the power of the entire signal captured in the spectrum view
- **Total Harmonic Distortion Percentage (THD)** – the ratio of the sum of harmonic powers to the power of fundamental frequency

$$\text{THD} = \frac{\sqrt{V_1^2 + V_2^2 + V_3^2 + V_4^2 + V_5^2}}{V_f}$$

- **Total Harmonic Distortion (THD) dB:** the ratio of the sum of harmonic powers to the power of fundamental frequency

$$\text{THD} = 10 \log_{10} \left(\frac{\sqrt{V_1^2 + V_2^2 + V_3^2 + V_4^2 + V_5^2}}{V_f} \right)$$

- **Total Harmonic Distortion and Noise (THD + N)** – the ratio of the harmonic power plus noise to the fundamental power

$$\text{THD} + \text{N} = 10\log_{10}\left(\frac{\text{THD} + \text{N}}{V_f}\right)$$

- **Spurious-free Dynamic Range (SFDR)** - the ratio of the amplitude of the highest peak in the spectrum to that of the second highest peak
- **SINAD** – signal to noise and distortion ratio. The ratio (in decibels) of the signal-plus-noise-plus-distortion to noise-plus-distortion

$$\text{SINAD} = 10\log_{10}\left(\frac{\text{Signal}}{\text{Noise} + \text{noise}}\right)$$

- **Signal Noise Ratio (SNR)** – the ratio (in decibels) of average signal power to average noise power

$$\text{SINAD} = 10\log_{10}\left(\frac{\text{Signal}}{\text{Noise}}\right)$$

- **Inter-modulation Distortion (IMD)** - a measure of distortion due to non-linear mixing of two tones

$$\text{IMD} = \sqrt{\frac{F_3^2 + F_4^2}{F_1^2 + F_2^2}}$$

➤ **To set the measurements**

1. Tap the **Measurement** button at the bottom of the screen to open the measurement dialog box.
2. Select the channel to be measured.
3. Select the appropriate measurement options. The **Whole Track** and **Ruler Track** can be toggled through the **Edit** icon in the lower corner of the option.



Figure 7-82 Sample Measurement Setting Screen

4. Close the dialog box, and the corresponding measurement readings are displayed on the right-hand side of the screen. Adjust the whole track or ruler track on the displayed screen or delete the measurement directly by tapping the **X** button.

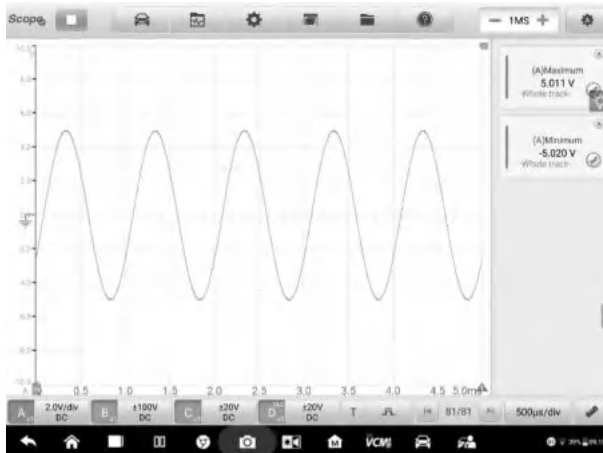

Figure 7-83 Sample Measurement Display Screen

➤ **To set the measurements in Spectrum View**

1. Tap the **Settings** button in the top navigation bar. A dialog box opens. Select the **Mode** option in the dialog box, and then tap to select **Spectrum View**.



Figure 7-84 Sample Spectrum View Selection Screen

2. Tap the **Measurement** button at the bottom of the screen to open the measurement dialog box.
3. Select the channel to be measured.
4. Select the appropriate measurement options.

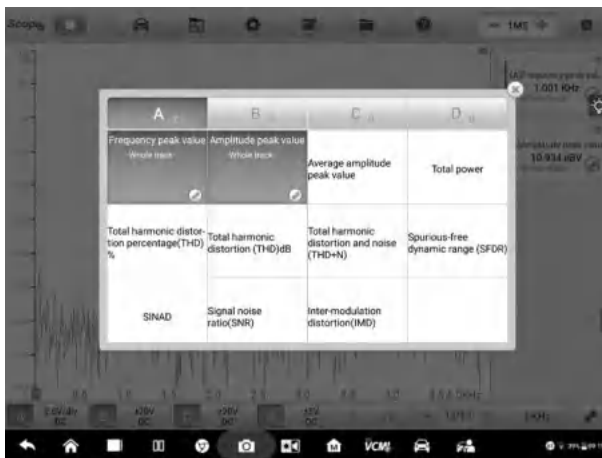

Figure 7-85 Sample Measurement Setting Screen (Spectrum View)

5. Close the dialog box, and the corresponding measurement readings are displayed on the right-hand side of the screen. Delete the measurement

directly by tapping the **X** button.

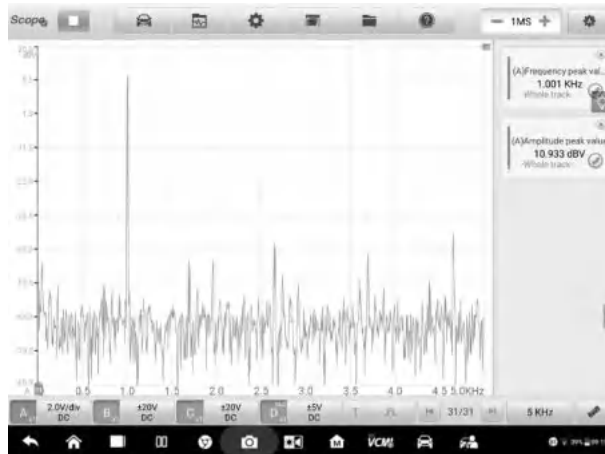

Figure 7-86 Sample Measurement Display Screen (Spectrum View)

7.1.6 Troubleshooting

A. If the oscilloscope cannot communicate with the MaxiSys Tablet:

- Ensure the VCMI device is properly connected to the MaxiSys Tablet via Wi-Fi or with the supplied USB cable.
- Restart the MaxiSys Tablet and reconnect the VCMI device if communication between the two continues to fail.

B. If unwanted signals are displayed or signals are distorted:

- Use only the supplied test leads or probes to connect with the input channels.
- Check the test leads or probes for damage.
- Ensure the polarity of the test leads connections are correct.
- Ensure the signal and ground connections are clean and secure.
- Ensure the ground lead is providing a direct ground from the circuit to the input channel.
- Isolate the test leads from other components, leads, or systems that may induct unwanted noise into the signal being tested including the electric motors, secondary ignition components, relays, alternators.

7.1.7 Glossary

AC/DC Control

Each channel can be set to either AC coupling or DC coupling. With DC coupling, the voltage displayed onscreen is equal to the true voltage of the signal with respect to ground. With AC coupling, any DC component of the signal is filtered out, leaving only the variations in the signal for the AC component.

Aliasing

When the signal frequency gets higher than half the scope's maximum sampling rate and exceeds the limit, a distorted waveform displays. This distortion is called aliasing.

Amplitude

The maximum voltage generated from the zero volts line of the oscilloscope.

Analog Bandwidth

The frequency at which a displayed sine wave has half the power of the input sine wave (about 71% of the amplitude).

Buffer Size/Cache Size

The size of the oscilloscope's buffer memory. The buffer memory is used by the oscilloscope to temporarily store data. This helps to compensate for the differences in data transfer rate from one device to another.

Frequency

The number of signal occurrences per second. Frequency is measured in Hz (hertz).

Peak to peak voltage

The difference in voltage between the minimum and maximum voltages occurring in the waveform.

Time Base

The time interval across the scope display.

Voltage Range

The range between the maximum and minimum voltages that can be accurately captured by the oscilloscope.

Sampling Rate

The number of samples per second captured by the oscilloscope. The faster the sampling rate of the scope, the more frequently it measures the signal voltage, and so the more detailed will be the trace that appears on the scope screen.

7.2 Multimeter

The multimeter is a multi-function, multi-range measuring instrument. When the VCMI (Vehicle Communication and Measurement Interface) device is connected with MaxiSys Ultra Tablet, you can open the **Multimeter** application by tapping the Measurement icon on the Home screen of the tablet and then tapping the multimeter icon, and perform the multimeter-related functions, such as measuring voltage, current, resistance, frequency, diode, duty cycle, pulse width and continuity test.

7.2.1 Safety Information

Follow the instructions below to reduce the risk of injury from electric shock and prevent equipment damage.

- Use the multimeter only as specified in this manual.
- Do not apply more than the rated voltage between connectors or between any connector and earth ground.
- Do not input a value beyond the range when measuring. Remember that the limit value range of this multimeter is 200V.
- To prevent injury or death, do not use the multimeter if it appears to be damaged in any way, and stop use immediately if you are concerned with any abnormal operations.
- To prevent injury or death, never ground yourself when taking electrical measurements. Isolate yourself from ground by using dry rubber insulating mats to cover all exposed/grounded metal. Ensure all clothing including gloves are dry. Stand on rubber mats when using tool.
- Use the test leads or probes supplied with the product, or proper and applicable terminals. Inspect the test leads or probes for damage before use.
- When using probes, keep fingers behind the finger guards on the probes.
- Use the supplied replacement fuses or specified replacement parts.
- Always consider electrical and electronic equipment to be energized (live). Never assume any equipment is de-energized.
- When making electrical connections, connect the common test lead before connecting the live test lead; when disconnecting, disconnect the live test lead before disconnecting the common test lead.
- When measuring current, turn off circuit power before connecting the multimeter to the circuit. Remember to place the multimeter in series with the circuit.
- After current measurement is finished, turn off the power to the circuit before

removing the test leads and before reconnecting any disconnected wires or devices.

- Do not add voltage to the input terminal when measuring resistance.
- To avoid electric shock, turn off the power to the component before connecting.
- To prevent damage, always use and store your multimeter in appropriate environments.
- Do not use in wet or damp conditions, or around explosive gas or vapor.
- Do not tamper with or disassemble the multimeter, connectors or accessories. Internal damage will affect performance.
- Before carrying out maintenance and cleaning of the multimeter, make sure the unit is NOT connected to a power source, vehicle or computer.
- When cleaning the multimeter, use a damp, soft cloth with mild detergent. Do not allow water to enter the multimeter casing.

7.2.2 General Introduction

7.2.2.1 Component Locations

The multimeter jacks are located on the top of the VCMI device while the input channels are located at the bottom.

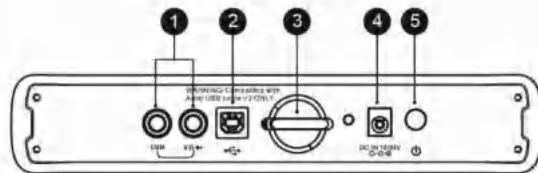

VCMI Top View

1. Multimeter Jacks – for ground and signal cables
2. USB Port
3. Hook
4. DC Power Supply Input Port
5. Power Button

! IMPORTANT

When using the multimeter function, please insert the supplied multimeter probes to the multimeter probe jacks. When measuring the current, use a current clamp to connect to the input channel A on the top of the VCMI device.

The multimeter LED is located on the front panel of the VCMI device. When the VCMI is properly connected and powered on, the multimeter LED lights green when operating in the multimeter mode.

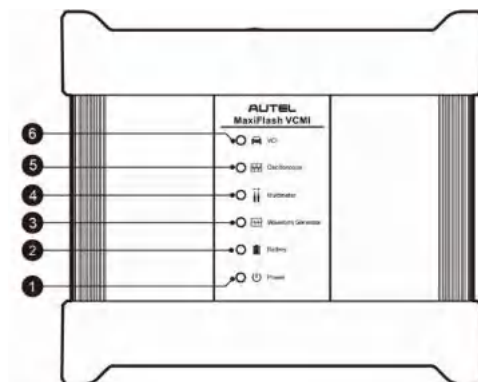

VCMI Front View

1. Power LED
2. Battery LED
3. Waveform Generator LED
4. Multimeter LED
5. Oscilloscope LED
6. Vehicle LED

7.2.2.2 Technical Specifications

Item	Description
Voltage Range	VDC 200V VAC 200V _{RMS}
Resistance Range	1Ω to 10MΩ
Diode	2V
Frequency Range	1Hz to 1MHz
Duty Cycle Range	1% to 99%
Pulse Width Range	1us to 1000ms

Item	Description
Current Range	● 0 to 65A (65A current clamp)
	● 0 to 650A (650A current clamp)

7.2.2.3 Accessories

The following accessories are compatible with the multimeter and oscilloscope. Please refer to [Accessories](#) on page 93 for details.



65A current clamp



650A current clamp



Large Dolphin Clip



Small Crocodile Clip



Multimeter Probe



Back-pinning Probe



Flexible Back-pinning Probe



Breakout Lead



Battery Clip

The two multimeter test leads (Red: SA015 / Black: SA016) are standard for the multimeter and waveform generator.



Multimeter Test Lead

Used to connect the multimeter and multimeter probe.

7.2.3 Getting Started

Before opening the Multimeter application, ensure the VCMi device is connected to the tablet via Wi-Fi network or with the supplied USB cable. For more information, see [Establish Vehicle Communication](#) on page 20.

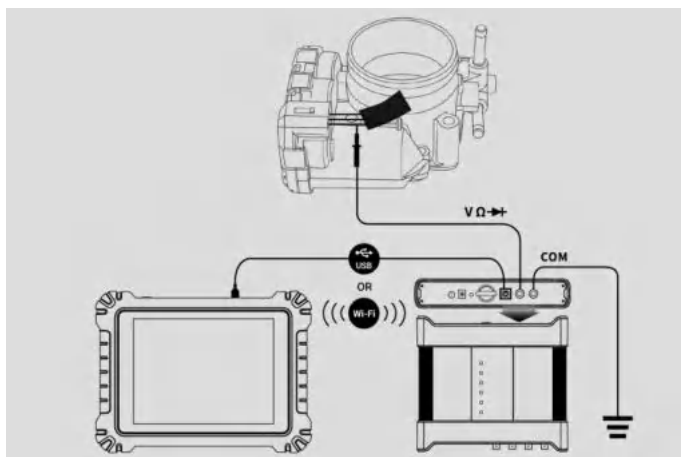

Figure 7-1 Sample Connection Diagram

➤ To open the multimeter application

1. Insert the applicable test leads or probe terminal ends into the multimeter jacks to complete the connection (refer to **Figure 7-1**).
2. Tap the **Measurement** icon on the Home screen of the MaxiSys Ultra Tablet. The Measurement screen opens.
3. Tap the **Multimeter** icon to open the Multimeter Menu.
4. Select a test to continue.



NOTE

Please check the multimeter LED status indicator on the front panel of VCMi device. The multimeter LED lights green when operating in the multimeter mode.

7.2.4 Multimeter Update

The operating software of the multimeter is continually optimized. Tap the **Help** button in the top toolbar and then tap the **Update the APK** button in the dropdown list to update the software.

Before update the multimeter's software, please ensure the tablet has a stable Internet connection.

7.2.4.1 APK Update

NOTE

The acronym APK (Android Package Kit) is used on the tablet and in this manual. This file contains all the assets of a particular app. To update the APK, is to install the latest version of the app on your tablet.

➤ To update the APK

1. Tap the **Help** button on the upper half of the screen. A dropdown menu displays.



Figure 7-2 Sample Help Screen

2. Tap the **Update the APK** in the dropdown menu. A confirmation message displays.

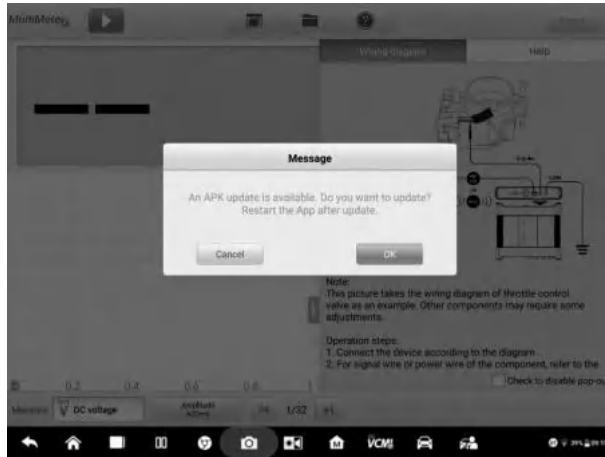

Figure 7-3 Sample Update Confirmation Screen

3. Tap **OK** to update the software or tap **Cancel** to exit.

7.2.5 Screen Layout and Operations

Tap the **Measurement** icon on the home screen then tap the **Multimeter** icon in the menu, the multimeter page displays. The screen typically includes the following button sections.

NOTE

The Multimeter application can also be opened via the Android home screen. Tap the **Measurement** icon at the top of the Android home screen. Tap **Multimeter** icon.

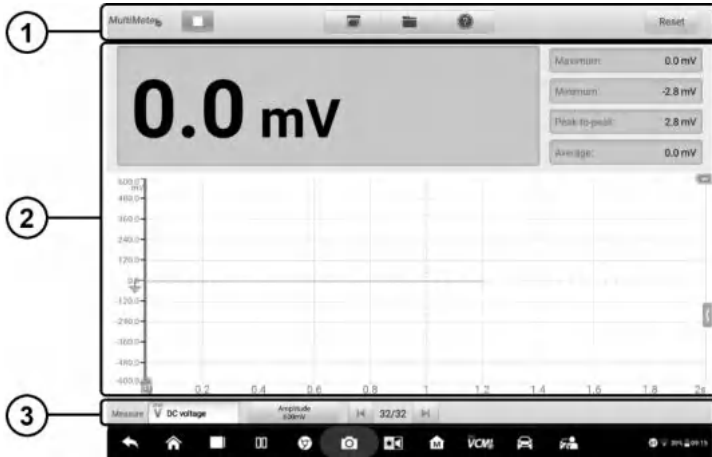





Figure 7-4 Sample Multimeter Menu Screen



1. Upper Toolbar - see [Upper Toolbar](#) on page 179 for details.
2. Main View Section – see [Main View Section](#) on page 183 for details.
3. Lower Toolbar - see [Lower Toolbar](#) on page 189 for details.

7.2.5.1 Upper Toolbar

The upper toolbar is used for configurations of various settings and operations. The following table provides brief descriptions of each button:

Table 7-1 Upper Toolbar

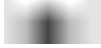
Name	Button	Description
Multimeter Icon		Displays the multimeter connection status. See Multimeter Icon on page 180 for more information.
Start/Stop Button		Start or stop the multimeter device. See Start/Stop Button on page 180 for more information.
Display Mode		Set the display mode. See Display Mode Menu on page 180 for more information.
File		Print, open and save the waveform data. See File Menu on page 181 for more information.



Name	Button	Description
Help		View the user manual, and update the APK. See Help Menu on page 183 for more information.
Reset		Reset the digital readouts displayed in the figure mode.

Multimeter Icon

This **Multimeter status button** displays the multimeter connection status. A **green** check mark means the tablet and the Multimeter are connected; a **red X** means the device and the tablet are not connected.

Start/Stop Button

Press this **Start/Stop Button** icon to start and stop the multimeter device.

Name	Button	Description
Start		Tap to start the multimeter.
Stop		Tap to stop the multimeter.

Display Mode Menu

The position of the digital readouts and waveform in the main view section can be selected in the Display Mode Menu.

➤ To set the display mode

1. Tap the **Display Mode** button in the top navigation bar. A submenu opens.

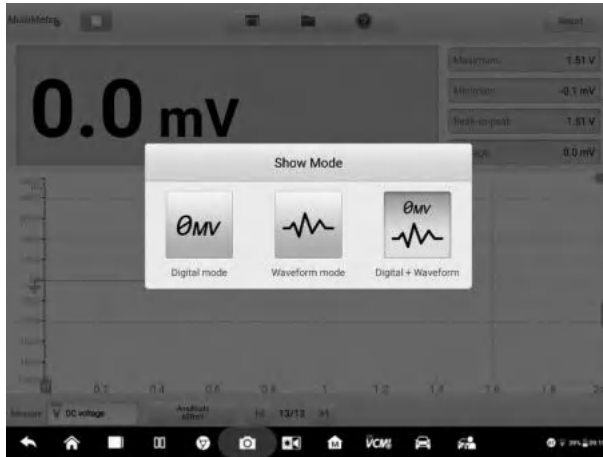

Figure 7-5 Sample Display Mode Menu Screen

2. Select one of the three display modes.
3. The corresponding display mode will be shown on the screen.

Table 7-2 Display Mode Table

Mode	Icon	Description
Digital Mode		Displays the digital readouts only.
Waveform Mode		Displays the waveform only.
Digital + Waveform Mode		Displays both the digital readouts and waveform.

File Menu

The file menu supports the following functions.

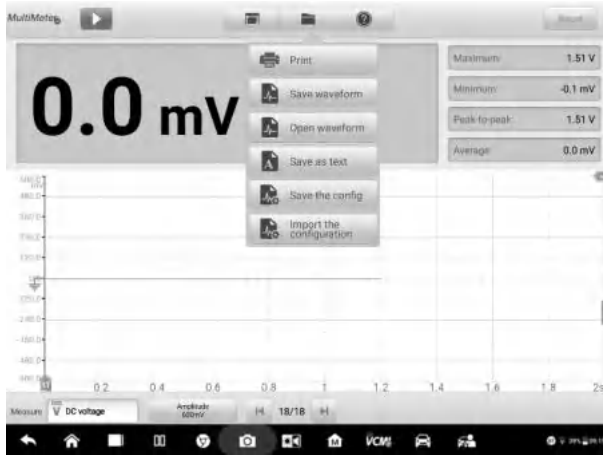

Figure 7-6 Sample File Menu Screen

- **Print** – Tap to create and print a temporary PNG picture of the current waveforms.

NOTE

Ensure the tablet is configured to print (see Printer setup instructions) and is connected to the printer. Ensure the tablet and printer share the same network.

- **Waveform File Operation**

Save and open the waveform files in this section. Only **Waveform** mode and **Digital + Waveform** mode support this operation.

Save Waveform – Tap to capture and save the current waveforms. On the Save File screen, tap each item to input the corresponding information and then tap **Save** or **Save Default** to finish.

NOTE

The file name is required when saving waveforms.

Open Waveform – Tap to retrieve the saved waveforms. Tap the **Edit** button in the upper right corner of the screen to select and delete the saved waveform.

Save as text – Tap to save the current waveform data to a text file. Use the ES File Explorer app on the Android home screen to review file: **Home > ES File Explorer > Local > Internal Storage > Scan > Data > Multimeter > txt**.

- **Configuration Operation**

The configurations can be saved and imported.

Save the Configuration – Tap to save the configuration settings (i.e., the amplitude, the time base) of waveforms on the current screen.

Import the Configuration – Tap to import the saved configuration settings for waveforms.

Help Menu

The Help Menu allows you to view the user manual, update the software, and view versions of the device.

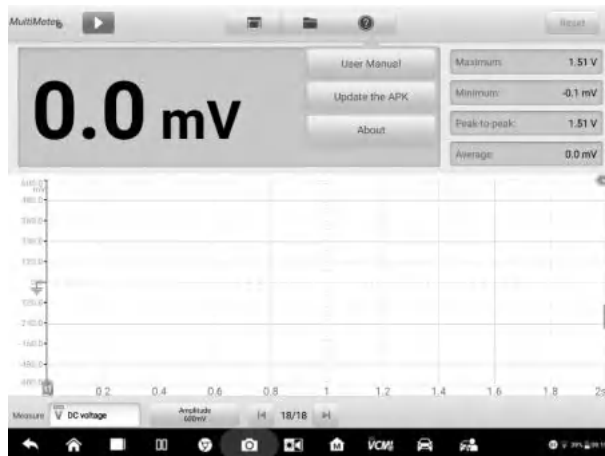

Figure 7-7 Sample Help Menu Screen

User Manual – displays instruction for the proper use of the multimeter.

Update the APK – connects to the Autel server to get the latest application software version.

About – displays the model number and version numbers of the installed software.

7.2.5.2 Main View Section

The main view section displays differently depending on the selected mode.

Digital Mode

The main view section in the digital mode displays only the digital readouts such as values of voltage measurement, maximum measurement, minimum measurement, peak to peak measurement and average measurement.

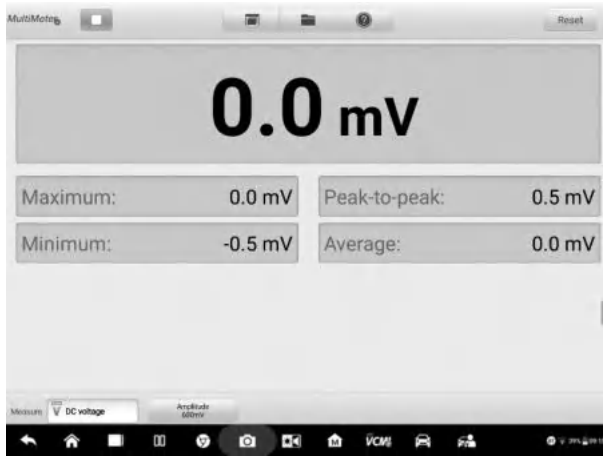

Figure 7-8 Sample Main View Section Screen (Digital Mode)

- **Current Value:** the current value can be the AC voltage, DC voltage, resistance, frequency, or duty cycle
- **Maximum:** the recorded maximum value of the measurement
- **Minimum:** the recorded minimum value of the measurement
- **Peak to Peak:** the difference between the maximum and minimum values
- **Average:** the average value of the measurements

Waveform Mode

The main view section in the scope mode only displays the waveform.



Figure 7-9 Sample Main View Section Screen (Waveform Mode)

The main view section features a coordinate grid with the **X-axis** representing the time duration and the **Y-axis** representing the amplitude level. The amplitude level on the Y-axis can be configured in the Amplitude Settings.

Channel Selection

In the main view section, a channel has two conditions: selected and unselected. A channel must be selected in order for the waveform to be movement, to use the zoom-in or to add measurement rulers.

➤ To select and unselect the channel

1. Tap the zero baseline marker or the Y-axis (the line thickens when selected).
2. Tap the zero baseline marker or the Y-axis again to exit the channel selection.

Waveform Zooming

The zooming function allows you to change the size and position of a signal during or after capturing a waveform to examine it in greater details. It does not change the stored data, but the way it displays.

The X-axis and Y-axis can be zoomed using your fingertips. The waveform can be zoomed during or after capturing the signal.

Measurement Rulers

In the coordinate grid, there are two kinds of **measurement rulers**, which allow the amplitude and time duration of a waveform to be measured precisely. They are useful when determining signal characteristics such as amplitude at specific points, the cycle time (duration) and frequency.

The vertical **Time Ruler** - Tap the **Ruler Activator** in the bottom left corner of the grid and drag it across the screen to the desired position. A **Time Ruler** is generated.

The horizontal **Signal Ruler** - The **Signal Ruler** can be generated in the similar way by tapping the **Ruler Activator** in the upper right corner and dragging it downwards.

NOTE

The horizontal signal ruler varies according to the settings of the voltage, current, frequency, duty cycle, etc.

When dragging the Measurement Rulers, a **Ruler Table** showing time and amplitude values for the corresponding channels will be displayed. The **Delta** icon refers to the absolute difference between the values of the rulers, which can be locked by tapping the **Lock** icon. Tap the **X** button in the upper right corner of the ruler table to delete all rulers.



Figure 7-10 Sample Measurement Rulers Screen

Zero Baseline

The zero baseline is marked the 0 value in the Y-axis, showing the ground level of each channel waveform. After the channel is selected, the zero baseline can be adjusted by dragging the baseline marker up/down along the Y-axis, or dragging the waveform up/down or moving the screen up/down in the grid.

NOTE

Tap the baseline marker to make the vertical scale line thicker. In this case, the channel is selected. Tap the baseline marker again to unselect and the waveform cannot be dragged.



Figure 7-11 Sample Zero Baseline Screen

Wiring Diagram and Help

Tap the arrow button in the lower right corner of the screen to open the Wiring Diagram and Help window.

The **Wiring Diagram** function provides the connection diagram, operation steps and operation notes.

The **Help** function provides the user manual, displaying information relevant to the procedure, operation or instructions.

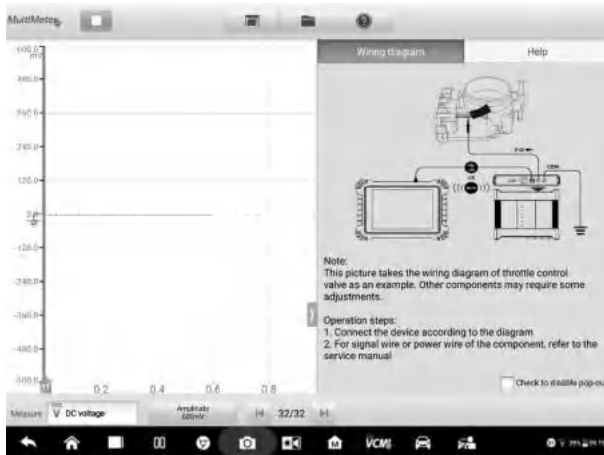

Figure 7-12 Sample Wiring Diagram and Help Screen

- **To open and close the Wiring Diagram and Help window**
 1. Tap the arrow button on the right-hand side of the screen.



Figure 7-13 Arrow Button Position Screen

2. The **Wiring Diagram and Help** window displays.
3. Tap the arrow button again or tap any space outside of the window.

Digital + Waveform Mode

In this mode, the main view section displays the digital readouts on the top and the waveform in the grid.

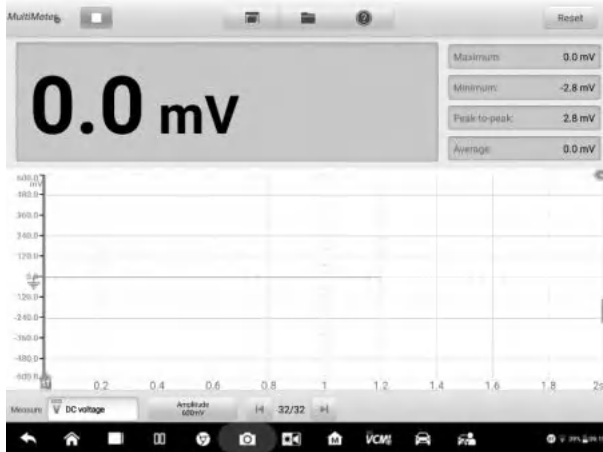

Figure 7-14 Sample Main View Section Screen (Digital + Waveform Mode)

7.2.5.3 Lower Toolbar

The measurement, buffer and amplitude can be configured in the lower toolbar.

Table 7-3 Lower Toolbar

Name	Button	Description
Measurement		Tap to select an appropriate measurement. See Measurement Setting on page 190 for more information.
Amplitude		Tap to select an appropriate amplitude value. See Amplitude Setting on page 191 for more information.
Buffer		Tap the Previous or Next button to switch to the previous or the next waveform. See Buffer on page 195 for more information.

Measurement Setting

This multimeter can be used to measure AC voltage, DC voltage, resistance, AC electricity, DC electricity, diode, frequency, duty cycle, pulse width, continuity and period.

The measurement types include:

- **AC/DC voltage:** measures the voltage in the electrical circuit
- **Resistance:** measures the resistance of the electrical circuit or the component
- **AC/DC current:** measures current amperage through the input channel A by using the optional current clamp



Note

The type of current clamp can be selected in the dropdown list.

- **Diode:** conducts the diode test of the electrical circuit
- **Frequency:** measures the frequency of the input signal
- **Duty Cycle (+)/(-):** measures the (+) and (-) duty of the input signal
- **Connectivity:** determines whether a low impedance exists two points in the electrical circuit. If the impedance is less than 100 ohms, the circuit is "closed", otherwise, the circuit is "open".
- **Period:** measures the amount the time that one complete cycle of the input signal endures
- **Pulse Width (+)/(-):** measures the pulse width of the input signal

➤ To set the measurement setting

1. Tap the **Measurement Setting** button in the lower left corner of the screen. A dialog box appears.

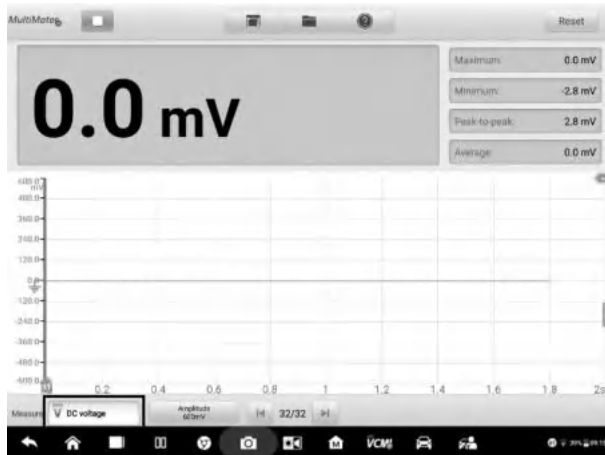

Figure 7-15 Sample Measurement Setting Position Screen

2. Select the **measurement type** you want to measure or test in the right column of the dialog box. The blue color indicates the option is selected.



Figure 7-16 Sample Measurement Setting Screen

3. Close the dialog box, the measurement type you set displays on the screen.

Amplitude Setting

Amplitude value can be configured for the selected measurement type excluding resistance measurement.

The amplitude settings allow you to set up the multimeter to capture signals within the specified range. If the input signal exceeds the selected range, an over-range indicator will be displayed. Select **Auto** to enable the device to adjust the vertical scale automatically.

There are two modes available to set the amplitude value.

Mode 1: For example, selecting **DC voltage** in Measurement setting screen sets the measurement type to DC voltage, selecting **10V** in Amplitude setting screen sets the amplitude to Amplitude 10V (displays on the lower left corner of the screen). The vertical scale range is from -10V to +10V. As the vertical scale is divided into 10 segments, each segment increases by 2V.

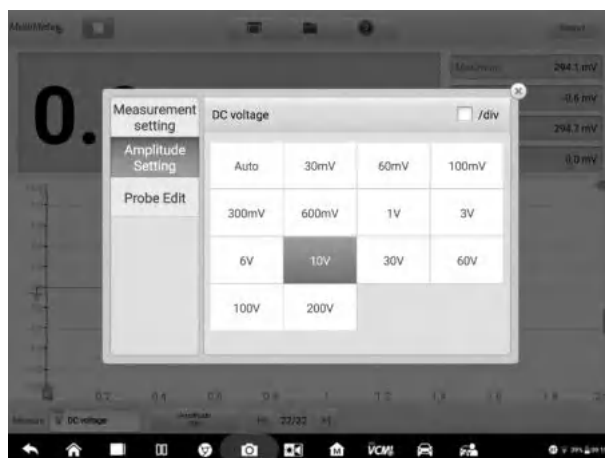

Figure 7-17 Amplitude Setting Screen (DC 10V)

Mode 2: Select the **## /div** button to adjust the value increments of each division. For example, selecting **DC voltage** in Measurement setting screen, sets the measurement type to DC voltage. Selecting **2.0V/div** in Amplitude setting screen, sets the amplitude to Amplitude 2.0V/div (displays on the lower left corner of the screen). Each segment increases by 2V. As the vertical scale is divided into 10 segments, the entire vertical scale range is from -10V to +10V.



Figure 7-18 Sample Amplitude Setting Screen (DC 2.0V/div)

Testing Procedures

The following section describes how to use the multimeter. The testing procedures are the same for each measurement type.

The following directions are for measuring AC voltage.

➤ To measure AC voltage

1. Tap the **Measurement Setting** button in the lower left corner of the screen to open the setting dialog box. Select **AC voltage** in the dialog box.
2. Set the proper amplitude value in the **Amplitude Setting** menu in the same dialog box.
3. Connect the supplied multimeter test lead to the VCM1 multimeter jacks. Insert the multimeter probe into the test lead.
4. Hold the probes to the correct points of the circuit.
5. Tap the **Start** button on the upper left corner of the screen to start the multimeter. The voltage displays onscreen.

🔍 Note

Use the optional current clamp connected to the input channel A when measuring currents. Use the supplied multimeter probes to connect with the multimeter jacks for other measurement types.

Probe Edit

Use the probe edit menu to add the not included probes into the probe menu.

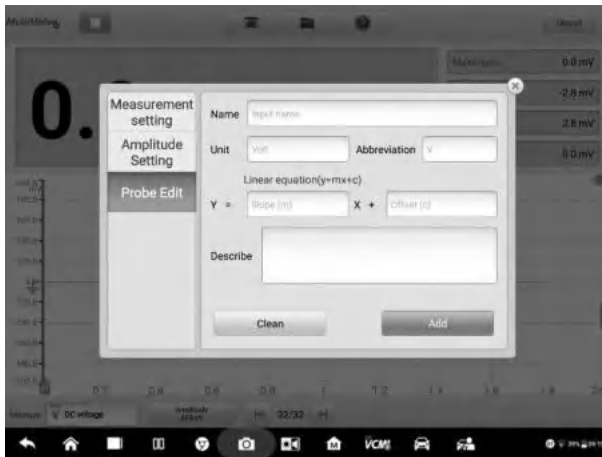

Figure 7-19 Sample Probe Edit Screen 1

➤ To add custom probes

1. Tap the **Measurement Setting** button in the lower left corner of the screen to open the setting dialog box.
2. Select the **Probe Edit** option in the left column of the dialog box.
3. Tap each field to open the virtual keyboard and input the required information.

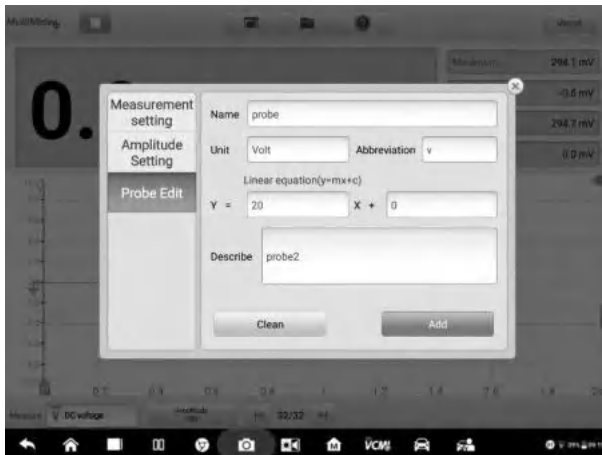

Figure 7-20 Sample Probe Edit Screen 2

4. Tap **Add** to save the settings, or tap **Clean** to exit without saving.
5. The added probe will be listed in the Measurement Settings window. Tap the **X** button in the upper right corner to close the dialog box.
6. After selecting the custom probe, connect a matching probe in the input channel A. The probe is connected to the signal position to be measured for measurement. At this time, the current measurement is displayed on the screen.



Figure 7-21 Sample Probe Edit Screen 3

Buffer

The waveform buffer displays the current waveform number and the total number of stored waveforms.

The multimeter can capture and store up to 32 waveforms. Tap the **Previous** or **Next** button to review waveforms.

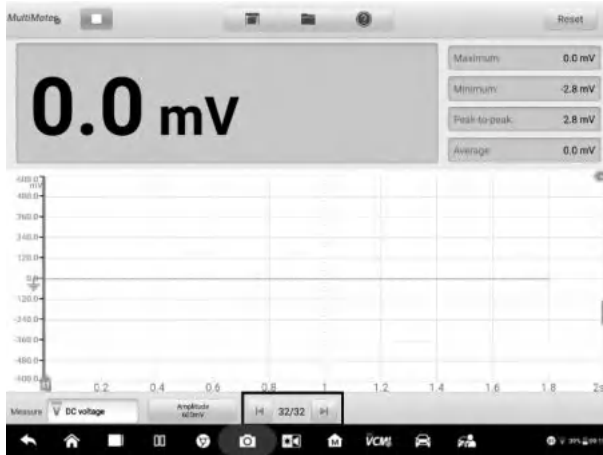





Figure 7-22 Sample Buffer Screen

Name	Button	Description
Previous		Tap to display the previous waveform in the buffer.
Buffer Index		Displays the number of the waveform currently displayed onscreen out of the total number of buffered waveforms.
Next		Tap to display the next waveform in the buffer.

7.2.6 Troubleshooting

If the multimeter cannot communicate with the MaxiSys Tablet:

- Check if the VCMI device is properly connected to the MaxiSys Tablet via Wi-Fi or the supplied USB cable.
- If the communication between the VCMI device and the MaxiSys still fails, restart the MaxiSys Tablet and reconnect the VCMI device.

7.2.7 Glossary

AC

Alternating Current - electrical current that switches polarity at regular intervals.

DC

Direct Current - electrical current that flows in one direction only.

Amperage

The strength of an electric current, expressed in amperes.

Amplitude

The maximum voltage generated from the zero volts line of the multimeter.

Frequency

The number of signal occurrences per second. Frequency is measured in Hz (hertz).

Duty Cycle

The length of a signals on time. Specified as a percentage (ratio), of the total cycle time.

Peak to Peak

The difference between maximum and minimum value.

Diode

Diode is an electronic device made of semiconductor materials, with a single conductivity.

Grid

A network of horizontal and vertical scales displayed on the screen that aids in the measuring of signal characteristics.

7.3 Waveform Generator

The signal generator is an instrument that simulates the signals of automotive electronic components. When the VCMI (Vehicle Communication and Measurement Interface) device is connected with MaxiSys Ultra Tablet, you can open the **Waveform Generator** application by tapping the Measurement icon on the Home screen of the tablet and then tapping the waveform generator icon, and perform the waveform generator-related functions, including simulating automotive sensor signals and actuator signals.

7.3.1 Safety Information

Follow the instructions below to reduce the risk of injury from electric shock and prevent equipment damage.

- Use the waveform generator only as specified in this manual.
- Do not apply more than the rated voltage between connectors or between any connector and earth ground.
- To minimize shock hazard, please connect the device ground input (chassis) to an electrical ground.
- Do not alter the ground connection. Without the protective ground connection, all accessible conductive parts can render an electric shock.
- To avoid electric shock hazard, disconnect power cable before removing covers.
- To prevent injury or death, do not use the waveform generator if it appears to be damaged in any way, and stop use immediately if you are concerned any abnormal operations.
- Inspect the test leads or probes for damage before use.
- Use the accessories supplied with the product.
- Use the supplied replacement fuses or specified replacement parts.
- To prevent damage, always use and store your waveform generator in appropriate environments.
- Do not place the waveform generator in an area that is directly exposed to sunlight or under high humidity.
- Do not tamper with or disassemble the waveform generator, connectors or accessories. Internal damage will affect performance.
- Disconnect waveform generator from power source, vehicle and tablet before cleaning.
- When cleaning the waveform generator, use a damp, soft cloth with mild detergent.

Do not allow water to enter the waveform generator casing

7.3.2 General Introduction

7.3.2.1 Component Locations

The multimeter jacks are used when operating the waveform generator. The two multimeter jacks are located on the top of the VCMI device.

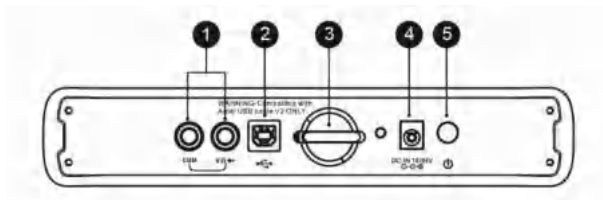

VCMI Top View

1. Multimeter Jacks – for ground and signal cables
2. USB Port
3. Hook
4. DC Power Supply Input Port
5. Power Button

The waveform generator LED is located on the front panel of the VCMI device. When the VCMI is properly connected and powered on, the waveform generator LED lights green when operating in the waveform generator mode.

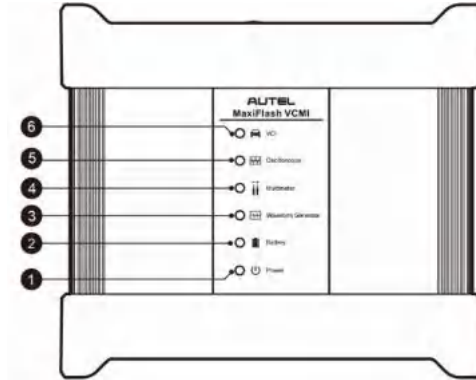

VCMI Front View

1. Power LED
2. Battery LED
3. Waveform Generator LED
4. Multimeter LED
5. Oscilloscope LED
6. Vehicle LED

7.3.2.2 Technical Specifications

Item	Description
Voltage Range	0.1 to 12V
Frequency Output	1Hz to 30KHz
Duty Cycle Range	1% to 99% (1Hz to 30KHz)

7.3.2.3 Accessories

The following accessories are compatible with the waveform generator and oscilloscope. Please refer to [Accessories](#) on page 93 for details.



Large Dolphin
Clip



Small Crocodile
Clip



Multimeter
Probe



Back-pinning
Probe



Flexible Back-
pinning Probe



Breakout Lead



Battery Clip

The multimeter test leads (Red: SA015 / Black: SA016) are standard for the waveform generator and multimeter.



Multimeter Test Lead

Used to connect the waveform generator and the probe.

7.3.3 Getting Started

Before opening the waveform generator application, the VCMI device must be connected to the Tablet via the provided USB cable or Wi-Fi network. For more information, see [Establish Vehicle Communication](#) on page 20.

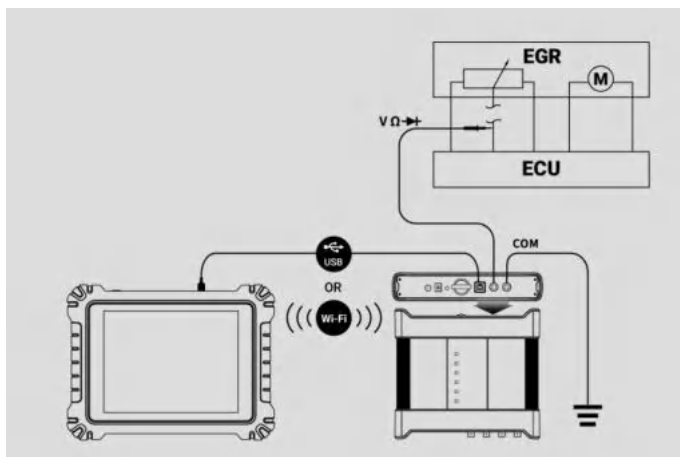

Figure 7-1 Sample Connection Diagram

➤ **To open the waveform generator application**

1. Insert the multimeter test lead ends into the multimeter jacks on the top of the VCMII device to complete the connection.
2. Tap the **Measurement** icon on the Home screen of the MaxiSys Ultra Tablet. The Measurement screen displays.
3. Tap the **Waveform generator** icon to open the waveform generator Menu.
4. Select a test to continue.

🔍 **NOTE**

Please check the waveform generator LED status indicator on the front panel of VCMII device. The waveform generator LED lights green when operating in the waveform generator mode.

7.3.4 Waveform Generator Update

The operating software of the waveform generator is continually optimized. Tap the **Help** button in the top toolbar and then tap the **Update the APK** button in the dropdown list to update the software.

Before update the waveform generator's software, please make sure the tablet has a stable Internet connection.

7.3.4.1 APK Update

NOTE

The acronym APK (Android Package Kit) is used on the tablet and in this manual. This file contains all the assets of a particular app. To update the APK, is to install the latest version of the app on your tablet.

To update the APK

1. Tap the **Help** button on the upper half of the screen. A dropdown menu displays.



Figure 7-2 Sample Help Screen

2. Tap the **Update the APK** in the dropdown menu. A confirmation message displays.



Figure 7-3 Sample Update Confirmation Screen

3. Tap **OK** to update the software or tap **Cancel** to exit.

7.3.5 Screen Layout and Operations

Tap the **Measurement** icon on the home screen and select **Waveform generator** from the menu, the waveform generator page displays. The screen typically includes the following button sections.

NOTE

The **Waveform generator** application can also be opened via the Android home screen. Tap the **Measurement** icon at the top of the Android home screen. Tap **Waveform generator** icon.

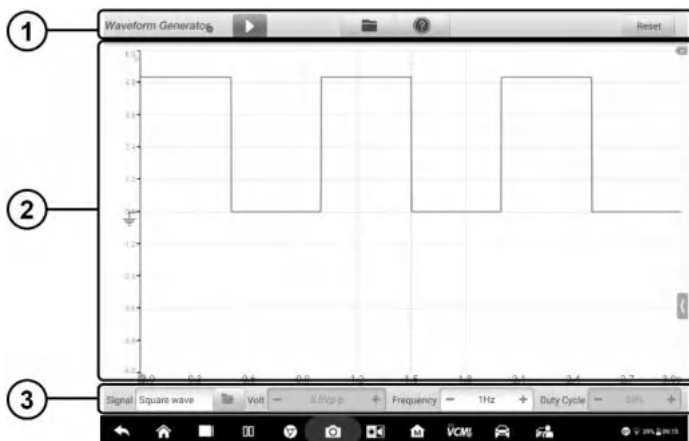





Figure 7-4 Sample Waveform Generator Menu Screen



1. Upper Toolbar - see [Upper Toolbar](#) on page 205 for details.
2. Main View Section – see [Main View Section](#) on page 208 for details.
3. Lower Toolbar - see [Lower Toolbar](#) on page 211 for details.

7.3.5.1 Upper Toolbar

The upper toolbar is used to configure settings and operations. The following table provides brief descriptions of each button.

Table 7-1 Upper Toolbar

Name	Button	Description
Waveform generator icon		Displays the waveform generator connection status. See Waveform generator Button on page 206 for more information.
Start/Stop		Start and stop the waveform generator device. See Start/Stop Button on page 206 for more information.
File		Print, open and save the waveform data. See File on page 206 for more information.



Name	Button	Description
Help		View the user manual, and update the software. See Help on page 207 for more information.
Reset		Reset the configurations and refresh the screen.

Waveform Generator Icon

This **Waveform generator icon** displays the waveform generator connection status. A **green** check mark means the tablet and the waveform generator are connected; a **red X** means the device and the tablet are not connected.

Start/Stop Button

You can tap the **Start/Stop Button** icon to start or stop the waveform generator device.

Name	Button	Description
Start		Tap to start the waveform generator.
Stop		Tap to stop the waveform generator.

File Menu

The file menu supports the following functions.

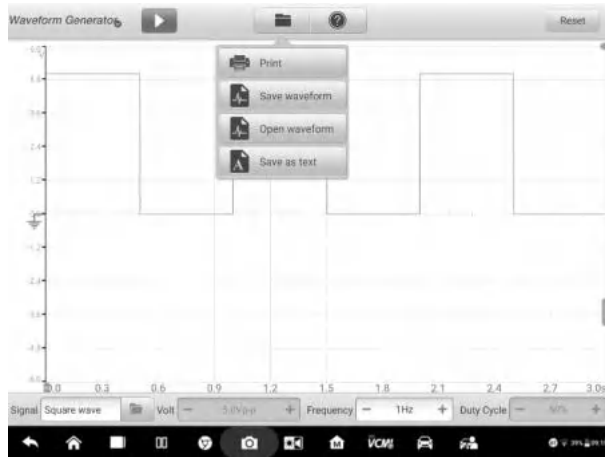

Figure 7-5 Sample File Menu Screen

- **Print** – Tap to create and print a temporary PNG picture of the current waveforms.

NOTE

Ensure the tablet is configured to print (see Printer setup instructions) and is connected to the printer. Ensure the tablet and printer share the same network.

- **Save Waveform** – Tap to capture and save the current waveform. On the Save File screen, tap each item to input the corresponding information and then tap **Save** or **Save Default** to finish.

NOTE

You must name the file to save the waveform.

- **Open Waveform** – Tap to retrieve the saved waveforms. Tap the **Edit** button in the upper right corner of the screen to select and delete the saved waveform.
- **Save as text** – Tap to save the current waveform data to a text file. Use the ES File Explorer app on the Android home screen to review file: **Home > ES File Explorer > Local > Internal Storage > Scan > Data > Signal > txt.**

Help Menu

The Help Menu allows you to view the user manual, update the software, and view versions of the device.



Figure 7-6 Sample Help Menu Screen

User Manual – displays instruction for the proper use of the waveform generator.

Update the APK – connects to the Autel server and get the latest application software version.

About – displays the model numbers and the installed versions of the software.

7.3.5.2 Main View Section

The main view section screen displays as a coordinate grid with **X-axis** and **Y-axis**, representing the duration and amplitude level respectively.

Channel Selection

In the main view section, a channel has two conditions: selected and unselected. A channel must be selected in order for the waveform to be movement, to use the zoom-in or to add measurement rulers.

➤ To select and unselect the channel

1. Tap the zero baseline marker or the Y-axis (the line thickens when selected).
2. Tap the zero baseline marker or the Y-axis again to exit the channel selection.

Waveform Zooming

The zooming function allows you to change the size and position of a signal during or after capturing a waveform to examine it in greater details. It does not change the stored data, only the way it displays.

The X-axis and Y-axis can be zoomed using your fingertips. The waveform can be zoomed during or after capturing the signal.

Measurement Ruler

In the coordinate grid, there are two types of **measurement rulers**, which allow the amplitude and duration of a waveform to be measured precisely. They are useful when determining signal characteristics such as amplitude at specific points, and the cycle time (duration).

The vertical **Time Ruler** - Tap the **Ruler Activator** in the lower left corner of the grid and drag it across the screen to the desired position. A **Time Ruler** is generated.

The horizontal **Signal Ruler** - The **Signal Ruler** can be generated in the similar way by clicking the **Ruler Activator** in the upper right corner and dragging it downwards.

When dragging the Measurement Rulers, a **Ruler Table** showing time and voltage values will be displayed. The **Delta** icon refers to the absolute difference between the values of the rulers, which can be locked by tapping the **Lock** icon. Tap the **X** button in the upper right corner of the ruler table to delete all rulers.

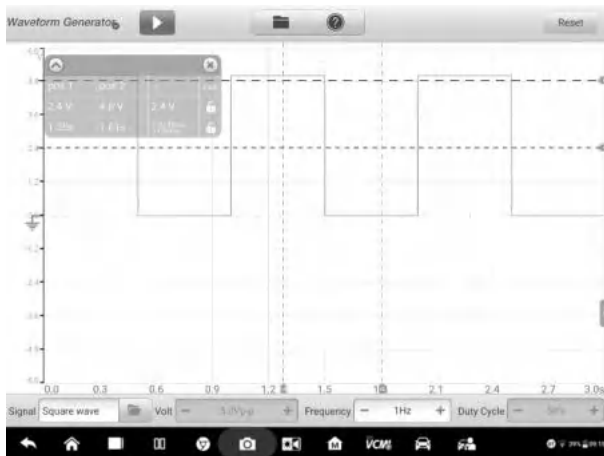

Figure 7-7 Sample Measurement Rulers Screen

Zero Baseline

The zero baseline is marked as the 0 value in the Y-axis, showing the ground level of each channel waveform. After the channel is selected, the Zero Baseline can be adjusted by dragging the zero baseline marker up/down along the Y-axis.

Wiring Diagram and Help

Tap the arrow button in the lower right corner of the screen to open the Wiring Diagram and Help window.

The **Wiring Diagram** function provides the connection diagram, operation steps and operation notes.

The **Help** function provides the content-sensitive help, displaying information relevant to the procedure, operation or instructions.

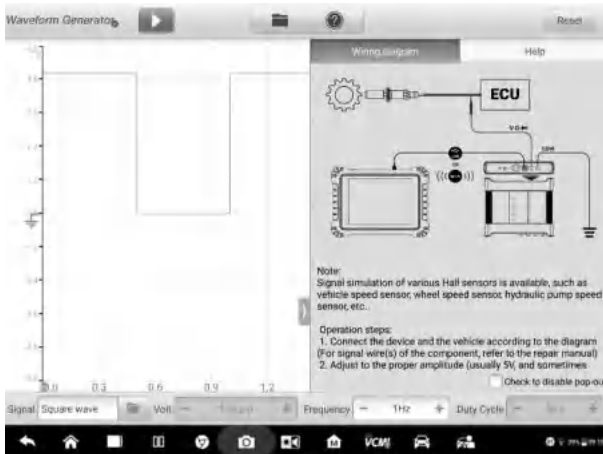

Figure 7-8 Sample Wiring Diagram and Help Screen

- **To open and close the Wiring Diagram and Help window**
 1. Tap the arrow button on the right-hand side of the screen.

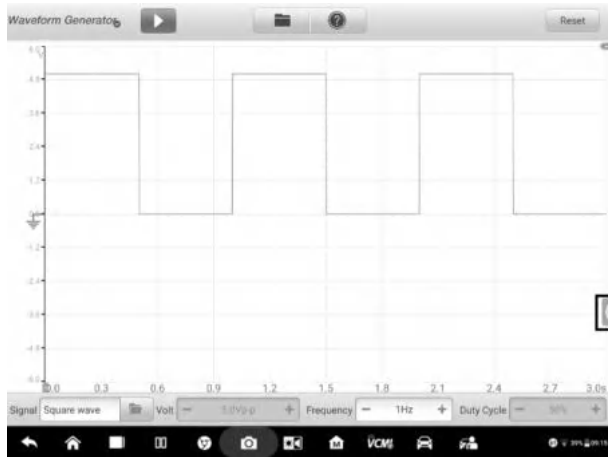

Figure 7-9 Arrow Button Position Screen

2. The Wiring Diagram and Help window displays.
3. Tap the arrow button again or tap any space outside of the window.

7.3.5.3 Lower Toolbar

The signal mode, voltage, frequency and duty cycle can be configured via the lower toolbar.

Table 7-2 Lower Toolbar

Name	Button	Description
Signal Mode Setting		Tap to select an appropriate signal mode. See Signal Mode Setting on page 212 for more information.
Voltage Setting		Tap to select an appropriate voltage value. See Voltage Setting on page 216 for more information.
Frequency Setting		Tap to select an appropriate frequency value. See Frequency Setting on page 219 for more information.

Name	Button	Description
Duty Cycle Setting		Tap to select an appropriate duty cycle value. See Duty Cycle Setting on page 221 for more information.

Signal Mode Setting

The waveform generator supports numerous signal modes including the DC voltage, square wave, square wave (X+Y), triangle wave, and actuators drive, and arbitrary waveform.



Figure 7-10 Signal Mode Setting Screen

DC Voltage

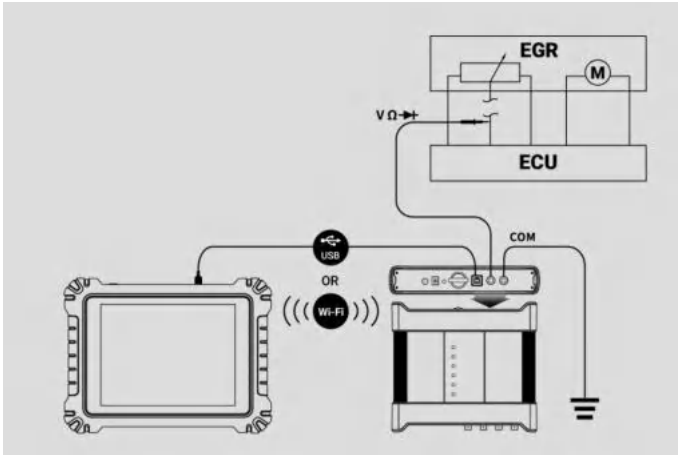

Figure 7-11 Sample DC Voltage Connection Diagram

Set the DC voltage in the waveform generator interface. The waveform generator can simulate the signals of numerous sensors including the water temperature sensor, oil pressure sensor and position sensor and then feed back to the engine ECU.

Actuator Drive

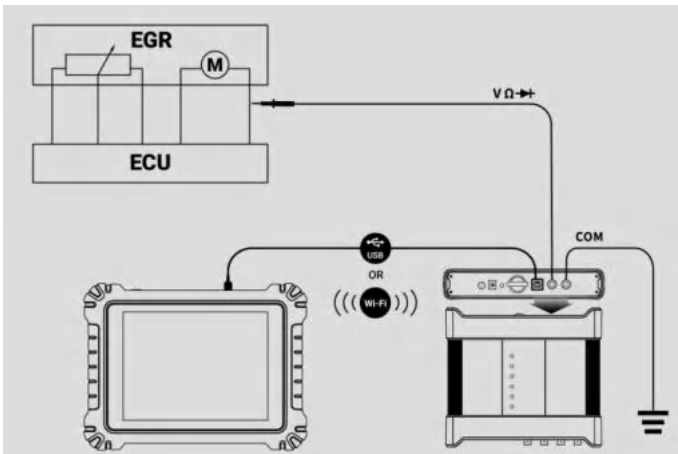

Figure 7-12 Sample Actuator Drive Connection Diagram

This function can drive 2-wire solenoid valve, solenoid coil and low-power motor, including the canister solenoid valve, injector solenoid valve, transmission hydraulic valve, hydraulic control valve, ignition coil, idle motor, and throttle motor.

It can change the operation speed and working time of the actuator by setting the frequency and duty cycle. The higher the frequency, the faster the speed, and the higher the duty cycle, the longer the working time, and vice versa.

NOTE

To avoid damaging the actuator, do not actuate it for a long time, and do not set too high a frequency.

This function needs to be tested on the car. If the actuator is removed, it cannot be driven individually.

NOTE

The maximum current supported by Actuator Drive cannot exceed 1.9A.

Square Wave

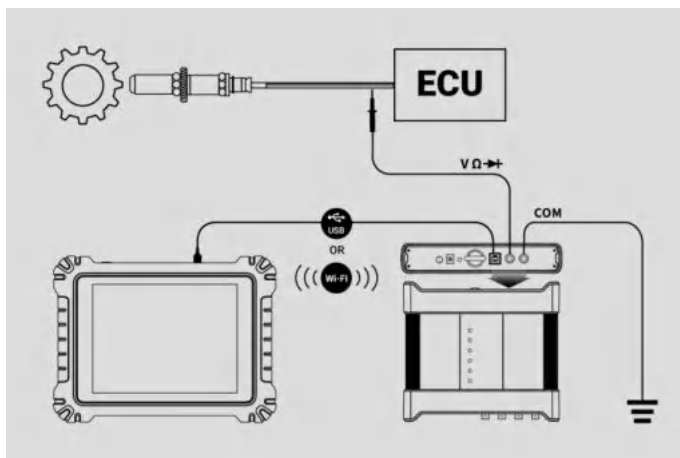

Figure 7-13 Sample Square Wave Connection Diagram

Once the voltage and frequency are set in the waveform generator interface, the square wave signals simulate the signals of various Hall sensors.

Square Wave (X+Y)

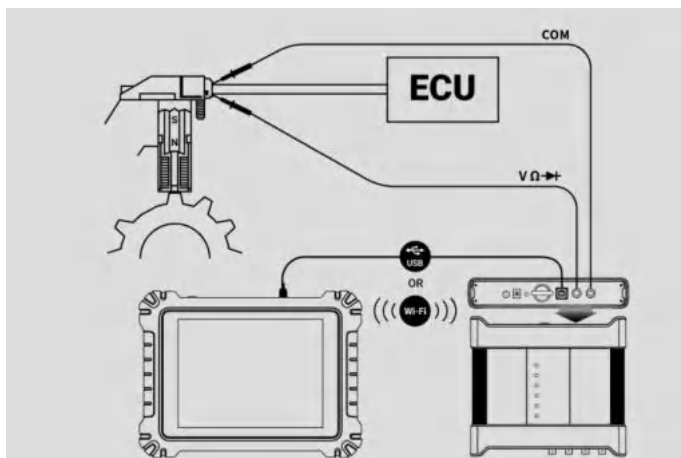

Figure 7-14 Sample Square Wave (X+Y) Connection Diagram

This function is mainly used to simulate the missing tooth signals of Hall-type crankshafts and camshafts. The X value represents the normal tooth signal and the Y represents the missing tooth signal. The default setting is 58+2, which can be adjusted as needed.

Triangle Waveform

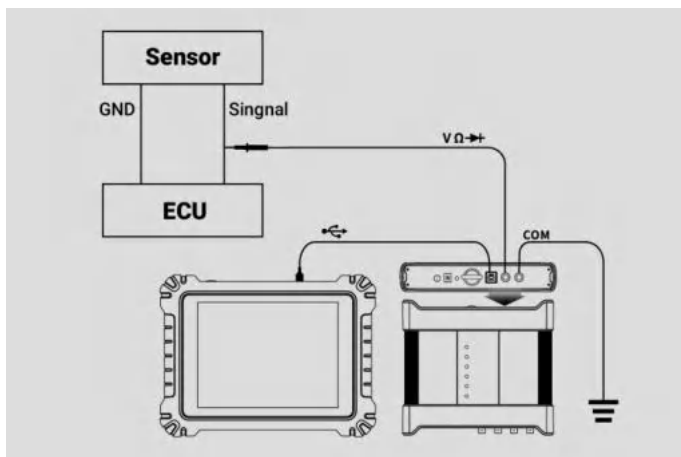

Figure 7-15 Sample Triangle Waveform Connection Diagram

This is a symmetrical triangular waveform, which is mainly used to simulate the triangle wave signals. The amplitude and frequency can be configured in this waveform.

Arbitrary Waveform

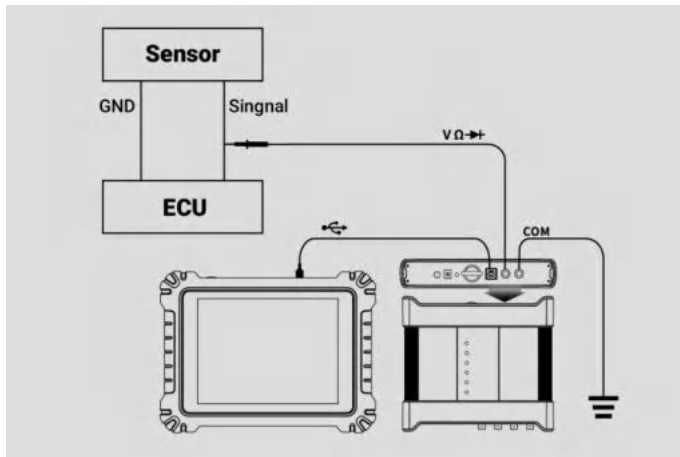

Figure 7-16 Sample Arbitrary Waveform Connection Diagram

Any type of the mentioned waveforms can be loaded again after the waveform and parameter settings are saved.

Voltage Setting

After you select the waveform mode, you can also set the amplitude value for that mode.

There are **three methods** to adjust the voltage value:

Method 1: Tap the **"+"** and **"-"** buttons at the bottom of the screen in the Voltage Setting.

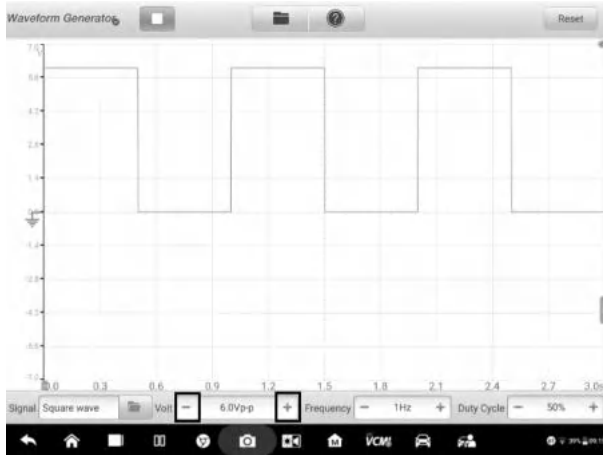





Figure 7-17 Sample Voltage Setting Screen 1

Range	Button	Description
0.1V to 0.9V		Raises the voltage by 0.1V
		Lowers the voltage by 0.1V
1V to 12V		Raises the voltage by 1V
		Lowers the voltage by 1V

Method 2: Tap the **Voltage Setting** button at the bottom of the screen to open a dialog box. Adjust the voltage value by tapping the **positive or negative value** at the bottom of the dialog box. Then tap **OK** to confirm or **Cancel** to exit without saving.

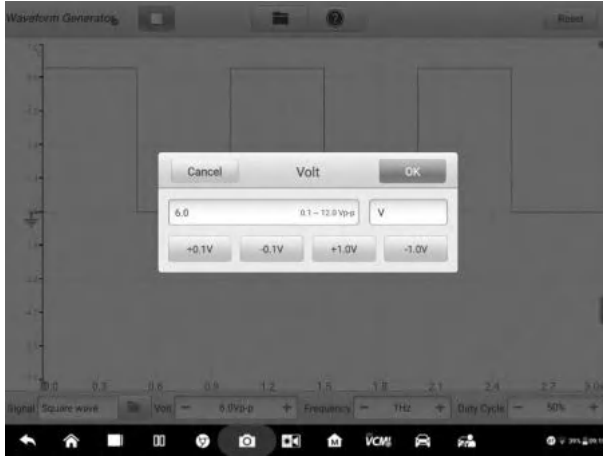

Figure 7-18 Sample Voltage Setting Screen 2

Value	Description
+0.1V	Raises the voltage by 0.1V
-0.1V	Lowers the voltage by 0.1V
+1.0V	Raises the voltage by 1V
-1.0V	Lowers the voltage by 1V

Method 3: Input the voltage value using the virtual keyboard. Tap the voltage field to clear the current value and input the new value. Tap **OK** to confirm or **Cancel** to exit without saving.



Figure 7-19 Sample Voltage Setting Screen 3

Frequency Setting

When the waveform mode is selected and the waveform generator is operating, you can also set the frequency value for that mode.

There are also three methods to adjust the frequency value:

Method 1: Tap the "+" and "-" buttons at the bottom of the screen in the Frequency Setting.

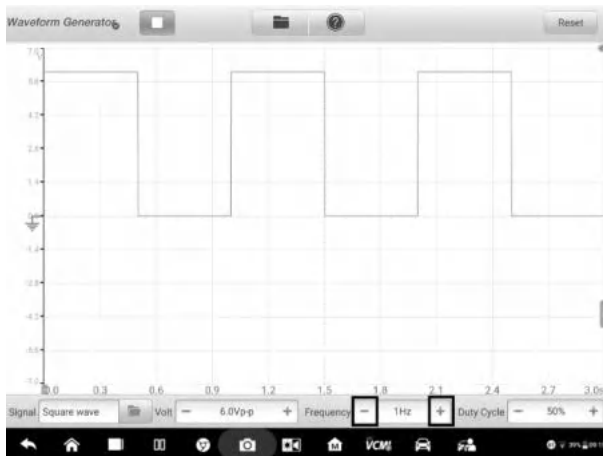









Figure 7-20 Sample Frequency Setting Screen 1

Range	Button	Description
1Hz to 10Hz		Raises the frequency by 1Hz
		Lowers the frequency by 1Hz
10Hz to 100Hz		Raises the frequency by 10Hz
		Lowers the frequency by 10Hz
100Hz to 1000Hz		Raises the frequency by 100Hz
		Lowers the frequency by 100Hz
1.0KHz to 30.0KHz		Raises the frequency by 1KHz
		Lowers the frequency by 1KHz

Method 2: Tap the **Frequency Setting** button at the bottom of the screen to open a dialog box. Adjust the frequency value by tapping the **positive or negative value** at the bottom of the dialog box. The unit of the frequency can be switched Hz to KHz. Tap **OK** to confirm or **Cancel** to exit without saving.

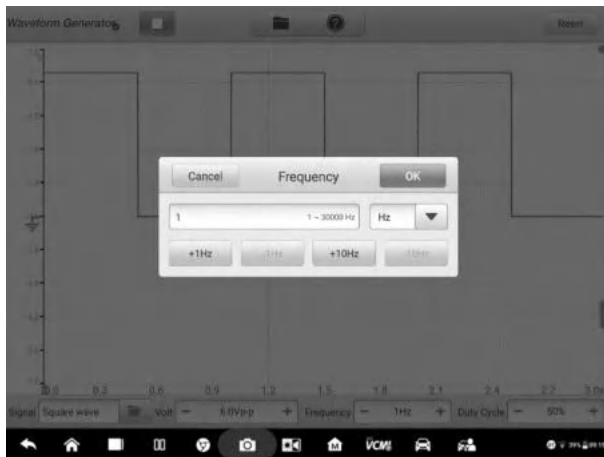

Figure 7-21 Sample Frequency Setting Screen 2

Value	Description
+1.0Hz	Raises the frequency by 1Hz
-1.0Hz	Lowers the frequency by 1Hz
+10.0Hz	Raises the frequency by 10Hz
-10.0Hz	Lowers the frequency by 10Hz
+1.0KHz	Raises the frequency by 1KHz
-1.0KHz	Lowers the frequency by 1KHz

Method 3: Input the frequency value using the virtual keyboard. Tap the frequency field to clear the current value and input the new value. Tap **OK** to confirm or **Cancel** to exit without saving.



Figure 7-22 Sample Frequency Setting Screen 3

Duty Cycle Setting

When the waveform mode is set, you can also set the duty cycle ratio for that mode.

There are three methods to adjust the duty cycle ratio:

Method 1: Tap the "+" and "-" buttons at the bottom of the screen in the Duty Cycle Setting.

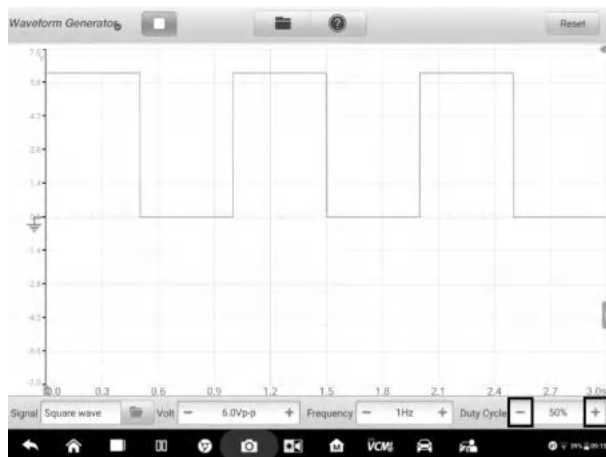



Figure 7-23 Sample Duty Cycle Setting Screen 1

Range	Button	Description
1% to 99%		Raises the duty cycle ratio by 1%
		Lowers the duty cycle ratio by 1%

Method 2: Tap the **Duty Cycle Setting** button at the bottom of the screen to open a dialog box. Adjust the duty cycle by tapping the **positive or negative ratio** at the bottom of the dialog box. Tap **OK** to confirm or **Cancel** to exit without saving.

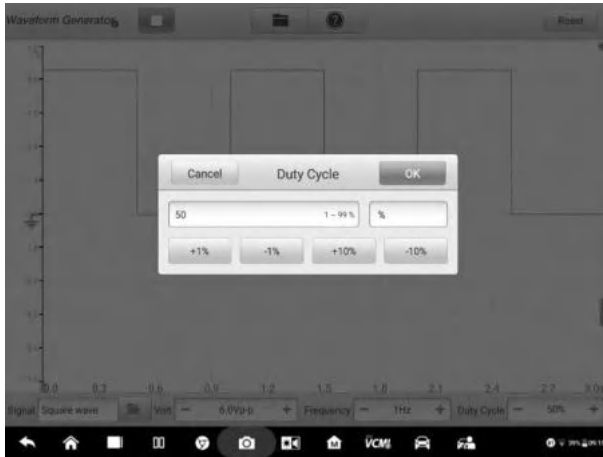

Figure 7-24 Sample Duty Cycle Setting Screen 2

Value	Description
+1.0%	Raises the duty cycle ratio by 1.0%
-1.0%	Lowers the duty cycle ratio by 1.0%
+10.0%	Raises the duty cycle ratio by 10%
-10.0%	Lowers the duty cycle ratio by 10%

Method 3: Input the duty cycle ratio using the virtual keyboard. Tap the duty cycle field to clear the current value and input the new value. Tap **OK** to confirm or **Cancel** to exit without saving.



Figure 7-25 Sample Duty Cycle Setting Screen 3

7.3.6 Troubleshooting

If the waveform generator cannot communicate with the MaxiSys Tablet:



- Check if the VCMI device is properly connected to the MaxiSys Tablet through the supplied USB cable.
- If the communication between the VCMI device and the MaxiSys Tablet still fails, restart the MaxiSys Tablet and reconnect the VCMI device.

IMPORTANT

To avoid damaging the vehicle and the equipment, all vehicle communications must be terminated before resetting the connection. The Internet connection may be aborted during resetting.

7.3.7 Glossary

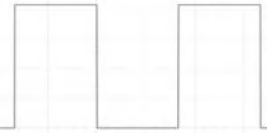
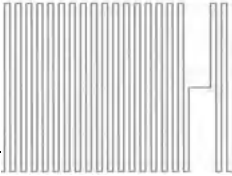
Waveform Type	Description	Sample Waveform
DC Voltage	A waveform with constant voltage	

Waveform Type	Description	Sample Waveform
Square Wave	The voltage waveform is a rectangular periodic signal	
Square Wave (X+Y)	A waveform signal of automobile crankshaft	
Triangle Wave	Periodic signal with triangular voltage waveform	

7.4 OBDII CAN Bus Check

OBDII CAN Bus Check is an instrument that detects the communication status of CAN Bus. When the VCMI (Vehicle Communication and Measurement Interface) device is connected with MaxiSys Ultra Tablet, you can open the **OBDII CAN Bus Check** application by tapping the Measurement icon on the Home screen of the tablet and then tapping the OBD icon, and perform the OBD-related functions including the signal detection. The indicator light flashes if the signals are detected. The indicator light displays in gray if no signal is detected.

Generally, the vehicle's electronic control systems are designed to comply with the specific communication protocols. The control units in the electronic control systems communicate with the Tablet through the OBDII (DLC) adapter.

With the OBDII CAN Bus Check function, you can check whether the control units in vehicle's electronic control systems work properly or not with the indicator light according to the condition of sending out the communication signals.

7.4.1 Safety Information

Follow the instructions below to ensure proper CAN Bus check performance.

- Different preconditions for different functions. Before check, please read the inspection guides carefully.
- The pin number for OBDII varies by vehicle modes. Please check and confirm for correct pin number and then proceed inspection.
- Select OBDII connector's signal pins manually if the test vehicle's actual communication signal pins are assigned differently.
- Ensure the DLC main cable is connected to the vehicle before inspection.
- Ensure the ignition key is in ON position when testing the vehicle's communication line.
- If the inspection fails due to no signal input, consult vehicle circuit diagram to ensure correct communications are being tested.
- Do not use in wet or damp conditions, or around explosive gas or vapor.
- Do not tamper with or disassemble the product, connectors or accessories. Internal damage will affect performance.
- Disconnect the product from power source, vehicle and tablet before cleaning.
- When cleaning the product, use a damp, soft cloth with mild detergent. Do not allow water to enter the product casing, as this will cause damage to the electronics inside.

7.4.2 General Introduction

7.4.2.1 Component Locations

The main connectors are located at the bottom of the VCMII device.

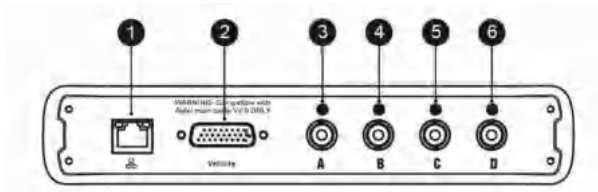

1. Ethernet Connector
2. Vehicle Data Connector
3. Input Channel A
4. Input Channel B
5. Input Channel C
6. Input Channel D

7.4.3 Getting Started

Before opening the OBDII CAN Bus Check application, you have to complete three steps below:

- 1) Connect the VCMII device to the Tablet via Wi-Fi or the supplied USB, see [Establish Vehicle Communication](#) on page 20.
- 2) Connect the VCMII device to the vehicle's OBDII connector.
- 3) Place the ignition in the key on position.

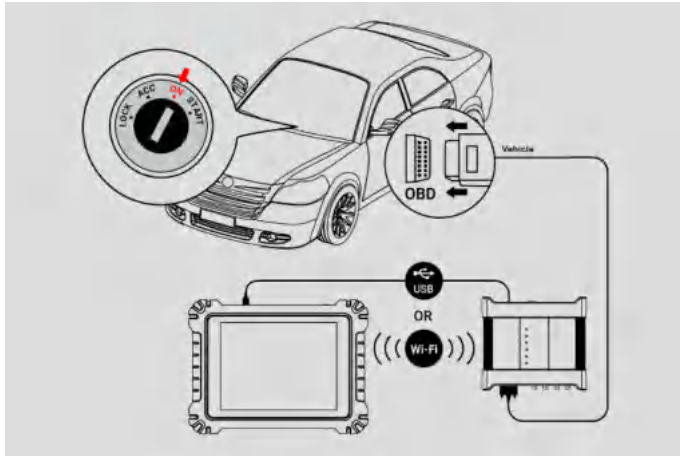

Figure 7-1 Sample Connection Diagram

➤ **To open the OBDII CAN Bus Check application**

1. Please refer to **Figure 7-1 Sample Connection Diagram** to complete the connection. Place the ignition in the key on position.
2. Tap the **Measurement** icon on the Home screen of the MaxiSys Ultra Tablet. The Measurement screen opens.
3. Tap the **OBD** icon to open the OBDII CAN Bus Check Menu.
4. Select a communication protocol to test.

7.4.4 OBDII CAN Bus Check Update

The operating software of the device is continually optimized. Tap the **Help** button in the top toolbar and then tap the **Update the APK** button in the dropdown list to update the software.

Before update the device's software, please make sure the tablet has a stable Internet connection.

7.4.4.1 APK Update

NOTE

The acronym APK (Android Package Kit) is used on the tablet and in this manual. This file contains all the assets of a particular app. To update the APK, is to install the latest version of the app on your tablet.

➤ **To update the APK**

1. Tap the **Help** button on the upper half of the screen. A dropdown menu displays.

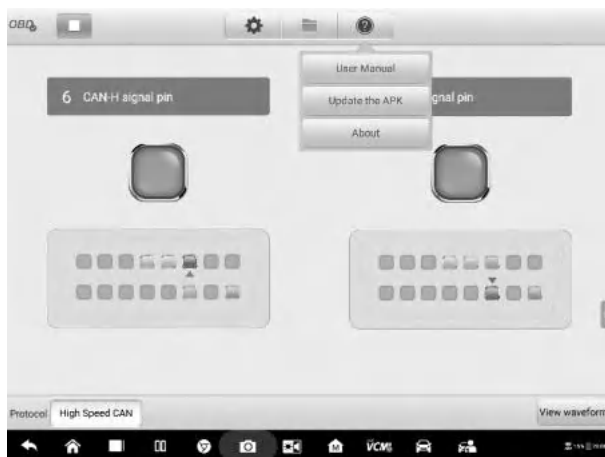

Figure 7-2 Sample Help Screen

2. Tap **Update the APK** in the dropdown menu. A confirmation message displays.

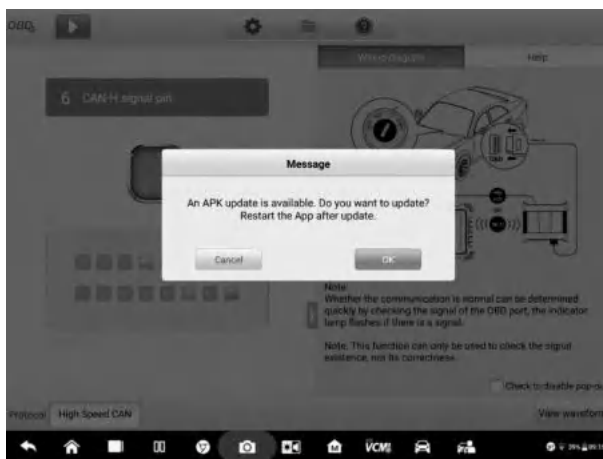

Figure 7-3 Sample Update Confirmation Screen

3. Tap **OK** to update the software or tap **Cancel** to exit.

7.4.5 Screen Layout and Operations

The OBDII CAN Bus Check application allows you to select the communication protocols, the signal pins and voltage value for testing.

Tap the **Measurement** icon on the home screen and select **OBD** in the menu, the OBDII CAN Bus Check window displays. The screen typically includes the following button sections.

NOTE

The OBDII CAN Bus Check application can also be opened via the Android home screen. Tap the **Measurement** icon at the top of the Android home screen. Tap the **OBD** app icon.

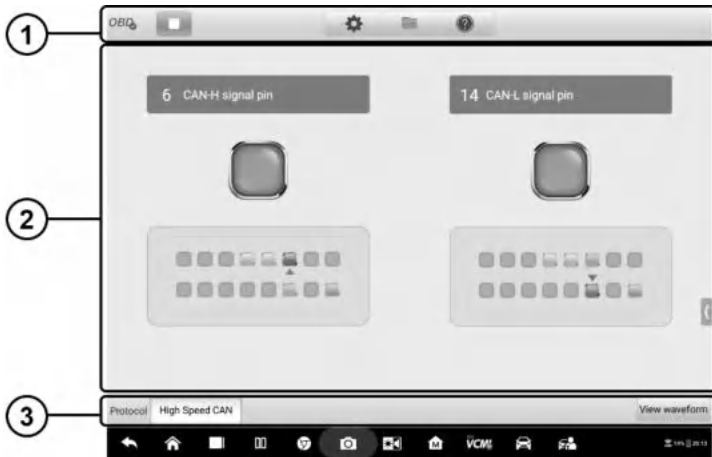





Figure 7-4 Sample OBDII CAN Bus Check Menu Screen

1. Upper Toolbar - see [Upper Toolbar](#) on page 230 for details.
2. Main View Section – see [Main View Section and Lower Toolbar](#) on page 235 for details.
3. Lower Toolbar– see [Main View Section and Lower Toolbar](#) on page 235 for details.

7.4.5.1 Upper Toolbar

The upper toolbar is used for configurations of various settings and operations. The following table provides brief descriptions of each button.

Table 7-1 Upper Toolbar

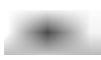

Name	Button	Description
OBD Icon		Displays the device connection status. See OBD Button on page 231 for more information.
Start/Stop		Start or stop the device. See Start/Stop Button on page 231 for more information.
Settings		Set the communication protocol pins manually. See Settings Menu on page 231 for more information.
File		Print, open and save the waveform data. See File Menu on page 233 for more information.
Help		View the user manual and update the software. See Help Menu on page 234 for more information.

OBD Icon

This OBD button indicates the OBD device connection status. A green check mark means the VCMI and the tablet are connected; a red X means no connection has been established.

Start/Stop Button

You can tap the **Start/Stop Button** icon to start or stop the device.

Name	Button	Description
Start		Tap to start the device.
Stop		Tap to stop the device.

Settings Menu

Tap the gear-shaped icon in the top navigation bar to enter the **Settings Menu**.

The pin number for OBDII may be different for different vehicle modes. In Settings Menu, you can select OBDII connector's signal pins manually if the test vehicle's actual communication signal pins are assigned differently.

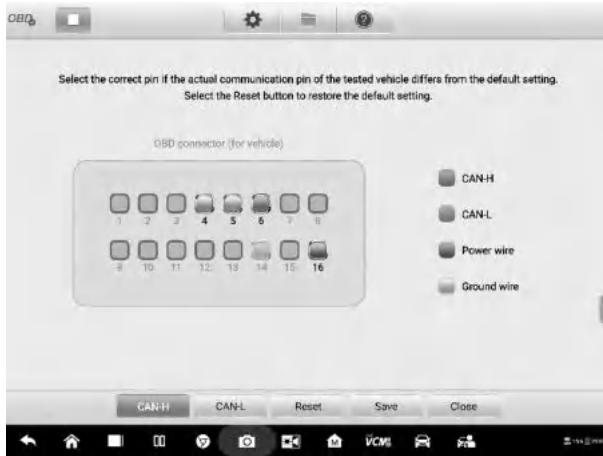

Figure 7-5 Sample Settings Menu Screen 1

At the bottom of the settings menu screen, the **Protocol**, **Reset**, **Save** and **Close** buttons are displayed. The protocol varies according to the protocol you set.

Take CAN protocol as an example.

CAN-H: select the pin assigned for high speed CAN-bus communication line

CAN-L: select the pin assigned for low speed CAN-bus communication line

Reset: restore the default settings

Save: save the changes when custom pin assignment is set

Close: exit the settings menu screen

➤ **To select the signal pins manually**

1. Tap the gear-shaped icon in the top navigation bar to enter the **Settings Menu**.
2. Tap **CAN-H** or **CAN-L** to select the communication protocol pins.



Figure 7-6 Sample Settings Menu Screen 2

3. Tap the correct pin number in the OBDII Connector Assignment image to match the test vehicle's actual communication signal pins.

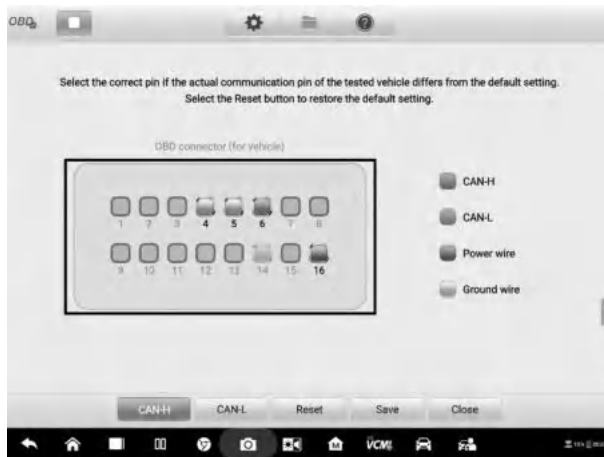

Figure 7-7 Sample Settings Menu Screen 3

4. Tap **Save** to save changes or tap **Close** to exit.

File Menu

The **File Menu** allows you to print, open and save the waveform data. The **File Menu** is enabled in the **Waveform Mode** and supports the following functions.



Figure 7-8 Sample File Menu Screen

- **Print** – Tap to create and print a temporary PNG picture of the current waveforms.

NOTE

Ensure the tablet is configure to print (see Printer setup instructions) and is connected to the printer. Ensure the tablet and printer share the same network.

- **Save Waveform** – Tap to capture and save the current waveforms. On the Save File screen, tap each item to input the corresponding information and then tap **Save** or **Save Default** to finish.

NOTE

A file name is required to save the waveform.

- **Open Waveform** – Tap to retrieve the saved waveforms. To select and delete the saved waveform, tap the **Edit** button in the upper right corner of the screen.
- **Save as text** – Tap to save the current waveform data to a text file. Use the ES File Explorer app on the Android home screen to review file: **Home > ES File Explorer > Local > Internal Storage > Scan > Data > OBD > txt.**

Help Menu

The Help Menu allows you to view the user manual, update the software, and view versions of the device.

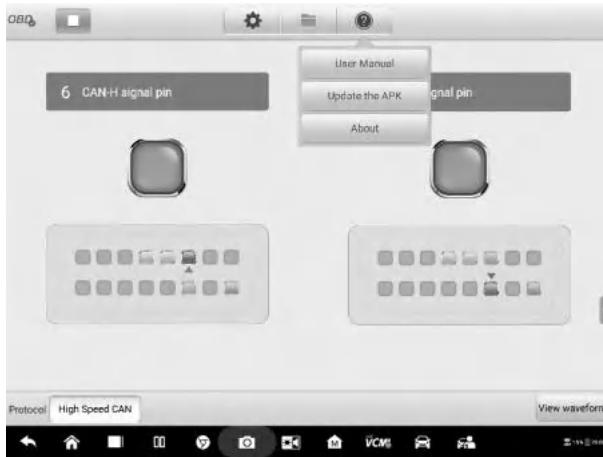

Figure 7-9 Sample Help Menu Screen

User Manual – displays instruction for the proper use of the OBDII CAN Bus Check application and the Ultra tablet.

Update the APK – connects to the Autel server and get the latest application software version.

About – displays the model number and the installed versions of the software.

7.4.5.2 Main View Section and Lower Toolbar

Two modes are available in the OBD communication line inspection function: Indicator Mode and Waveform Mode.

Indicator Mode

This mode is designed to show the condition of voltage fluctuation in vehicle's communication lines. In this mode, the indicator light of a selected pin flashes when the electronic control units are sending signals properly.

The Indicator Mode displays by default.

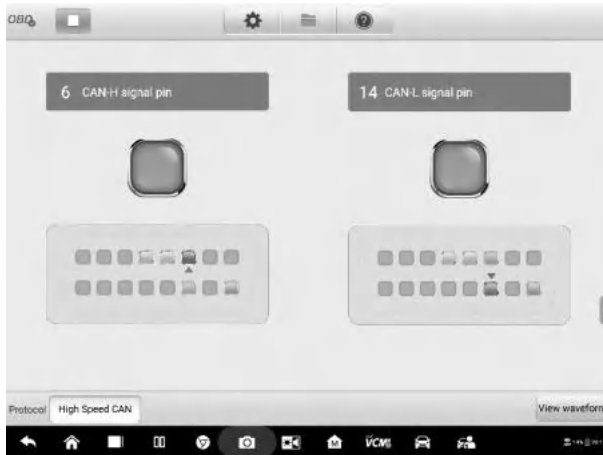

Figure 7-10 Sample Indicator Mode Screen

Main View Section

The **CAN-High** line is assigned to **Pin 6** and the **CAN-Low** line is assigned to **Pin 14** of the OBDII adapter by default according to the **CAN-Bus** standard protocol.

If the test vehicle's actual communication signal pins are assigned differently, you can select OBDII connector's signal pins manually in the [Settings Menu](#).

When the electronic control units send out signals properly, the left and right indicator lights will flash consecutively on the screen.

NOTE

The flashing indicator lights serve to confirm only that communication signals have been detected.

Lower Toolbar

- **Protocol Button**

In the left lower corner of the screen, you can select the protocol you want to test.

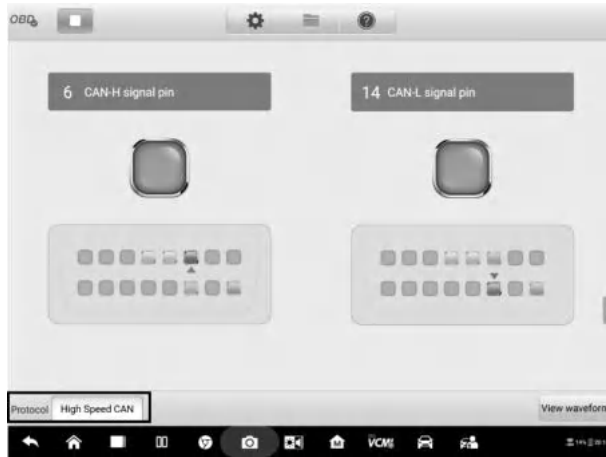

Figure 7-11 Sample Protocol Button Screen

The following protocols are included:

- ✧ **High Speed CAN** - offers baud rates from 40 Kbit/s to 1 Mbit/sec, depending on cable length. This is the most popular standard for the physical layer, since it allows for simple cable connection between devices. High speed CAN networks are terminated with 120 ohm resistors on each end of the network.
- ✧ **Low Speed CAN** - offers baud rates from 40 Kbit/s to 125 Kbits/sec. This standard allows CAN bus communication to continue in case of a wiring failure on the CAN bus lines. In low speed CAN networks, each device has its own termination.
- ✧ **Single CAN** - offers baud rates up to 33.3 Kbit/s (up to 88.3 Kbit/s for high-speed mode)
- ✧ **J1939 CAN** - is used in the commercial vehicle area for communication throughout the vehicle with the physical layer defined in ISO 11898. Under J1939/11 and J1939/15, the data rate is specified as 250 Kbit/s, with J1939/14 specifying 500 Kbit/s.
- ✧ **J1850 (PWM)** - SAE J1850 pulse-width modulation offers baud rates up to 41.6 Kbit/s, standard of the Ford Motor Company
- ✧ **J1850 (VPW)** - SAE J1850 variable pulse width offers baud rates up to 10.4 Kbit/s, standard of the General Motors
- ✧ **J1708 (SAE)** - the standard defines a double-wire 18-gauge cable that can run up to 130 feet (40 m) and operates at 9600 bit/s
- **View Waveform Button**

In the right lower corner of the screen, you can enter to the Waveform Mode by tapping the **View Waveform** button.

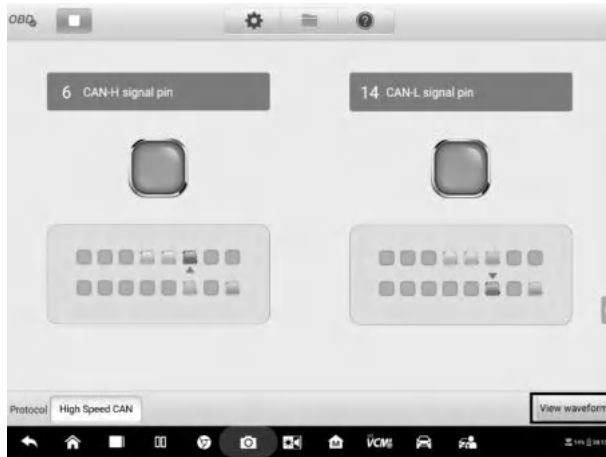

Figure 7-12 Sample View Waveform Button Screen

Test Procedure

The test procedure is the same for all the protocols.

➤ To test the communication line

Using High speed CAN-bus line as an example.

1. Make sure the VCMI is connected to the vehicle's OBDII connector. The VCMI is connected with tablet successfully. Please refer to the [Connection Diagram](#).
2. Place the ignition in the key ON position.
3. Tap the **Measurement** icon on the Home screen of the MaxiSys Ultra Tablet. The Measurement screen opens. Tap the **OBD** icon to open the OBD menu screen. Select the **High Speed CAN** protocol in the lower corner of the screen.
4. Tap the **Start** button on the upper left corner of the screen to start the device. The OBDII connector pin number that the signals are using is indicated, and the indicator light flashes if the signals are detected. Otherwise, the indicator light displays in gray.

ⓘ NOTE

If the indicator light is not flashing, ensure the ignition is in the key ON position and that signal pin assignment is correct.

Waveform Mode

This mode allows you to view the test result in a waveform form. This mode offers greater details and offers a larger number of configuration options.

The screen is displayed in the Indicator mode by default.

Tap the **View Waveform button** in the lower corner of the Indicator Mode screen to switch to the Waveform Mode. The screen is shown as below.

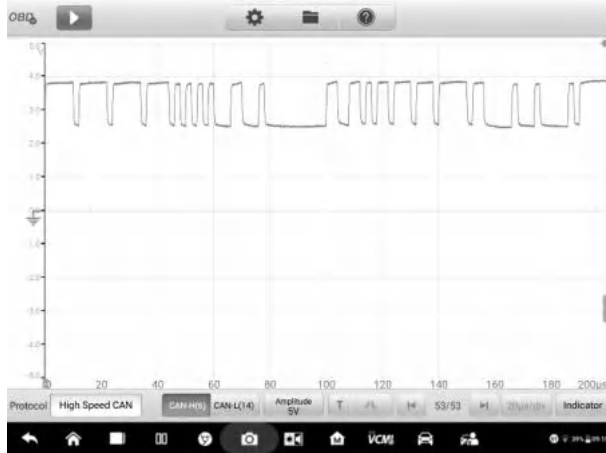

Figure 7-13 Sample Waveform Mode Screen

Main View Section

The main view section features as a coordinate grid with **X-axis** and **Y-axis**, representing the time duration and amplitude level respectively. The amplitude level can be configured in the Amplitude Settings and the time duration can be set in the Time Base Settings.

Channel Selection

Each channel has two conditions: selected and unselected. Some operations depend on the selected condition of the channel, such as measurement rulers, waveform movements and waveform zooming.

➤ To select and unselect the channel

1. Tap the zero baseline marker or the Y-axis (the line thickens when selected).
2. Tap the zero baseline marker or the Y-axis again to exit the channel selection.

Waveform Zooming

The zooming function allows you to change the size and position of a signal during or after capturing a waveform to examine. It does not change the stored data, only the way it displays.

The X-axis and Y-axis can be zoomed using your fingertips. The waveform can be zoomed during or after capturing the signal.

Measurement Rulers

In the coordinate grid, there are two types of **measurement rulers**, which allow the amplitude and time duration of a waveform to be measured precisely. They are useful when determining signal characteristics such as amplitude at specific points, the cycle time (duration) and frequency.

The vertical **Time Ruler** - Tap the **Ruler Activator** in the bottom left corner of the grid and drag it across the screen to the desired position. A **Time Ruler** is generated.

The horizontal **Signal Ruler** - The **Signal Ruler** can be generated in the similar way by clicking the **Ruler Activator** in the top right corner and dragging it downwards.

When dragging the Measurement Rulers, a **Ruler Table** showing time and voltage values for the corresponding channels will be displayed. The **Delta** icon refers to the absolute difference between the values of the rulers, which can be locked by tapping the **Lock** icon. Tap the **X** button in the upper right corner of the ruler table to delete all rulers.

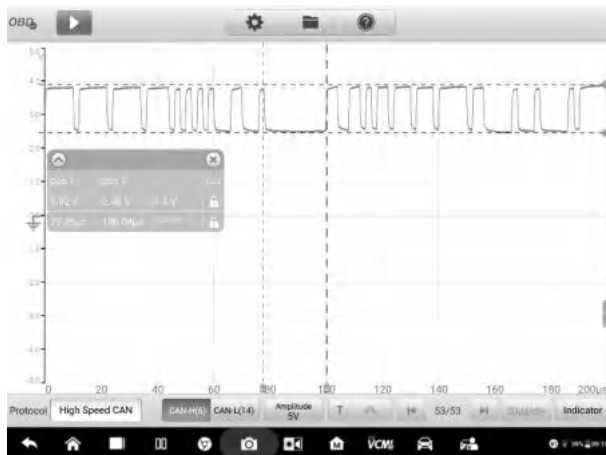

Figure 7-14 Sample Measurement Rulers Screen

Zero Baseline

The zero baseline is marked as the 0 value in the Y-axis, showing the base level of each channel waveform. After the channel is selected, the zero baseline can be adjusted by dragging the baseline marker up/down along the Y-axis, or dragging the waveform up/down or moving the screen up/down in the grid.

NOTE

Tap the baseline marker to make the vertical scale line thicker. In this case, the channel is selected. Tap the baseline marker again to unselect and the waveform cannot be dragged.

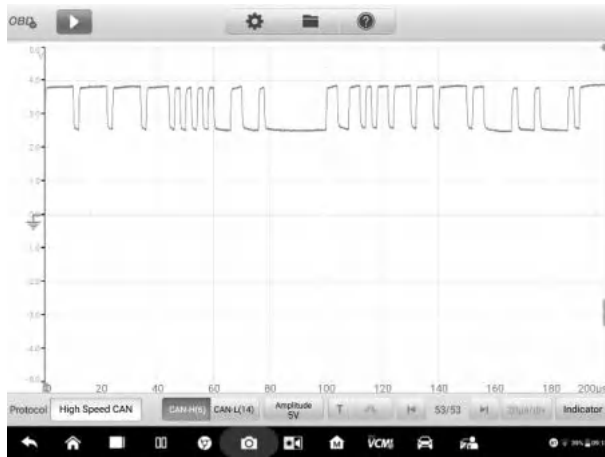
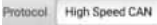







Figure 7-15 Sample Zero Baseline Screen

Lower Toolbar

The protocol, buffer and time base can be configured at the lower toolbar.

Table 7-2 Lower Toolbar

Name	Button	Description
Protocol		Tap to select an appropriate protocol. See Protocol Setting on page 242 for more information.
Communication Line		Tap to select the appropriate communication line. See Communication Line on page 243 for more information.

Name	Button	Description
Amplitude		Tap to select an appropriate amplitude value. See Amplitude Setting on page 243 for more information.
Trigger		Tap to open the trigger setting menu. See Trigger on page 244 for more information.
Buffer		Tap the Previous or Next button to switch to the previous or the next waveform. See Buffer on page 248 for more information.
Time Base		Tap to select an appropriate time per division. See Time Base on page 249 for more information.
Indicator		Tap to switch to the Indicator mode.

- **Protocol Setting**

Seven types of communication protocols are available: High Speed CAN, Low Speed CAN, Single CAN, J1939 CAN, J1850 (PWM), J1850 (VPW) and J1708 (SAE).

- **To select a protocol**

1. Tap the **Protocol** in the lower left corner of the screen. A dialog box opens.

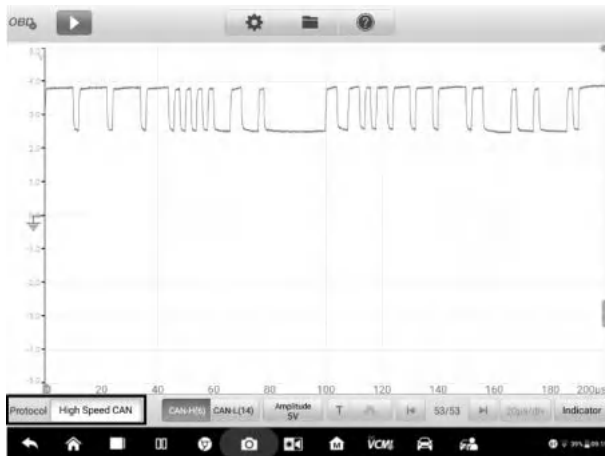

Figure 7-16 Sample Protocol Type Button Screen

2. Select the desired **Protocol type** in the dialog box.

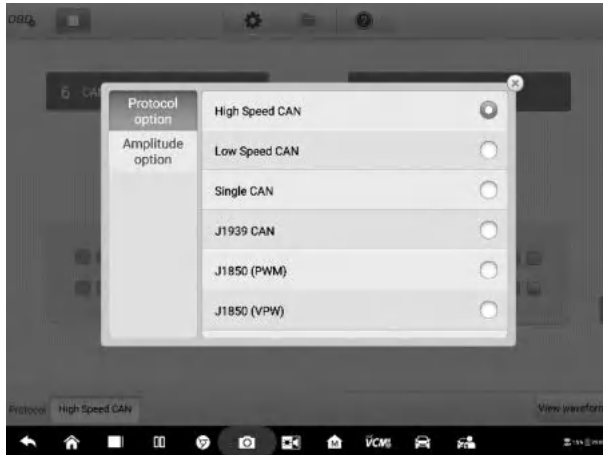

Figure 7-17 Sample Protocol Setting Screen

3. Tap the **X** icon to close the dialog box.

- **Communication Line**

The communication line selection varies according to the protocol selected. Tap the appropriate communication line at the bottom of the screen.

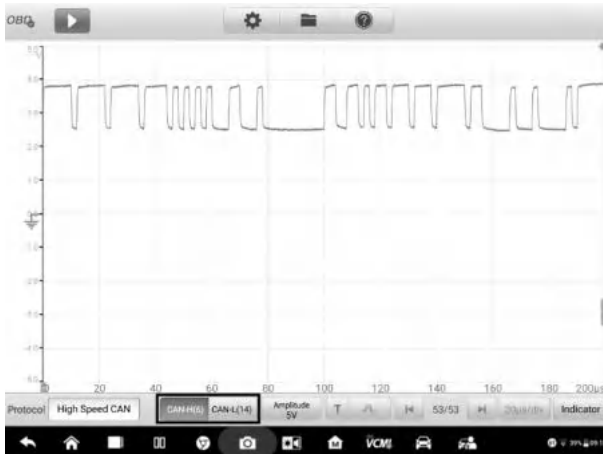

Figure 7-18 Sample Communication Line Button Screen

- **Amplitude Setting**

After selecting the protocol type, you can also set the amplitude value for that type.

➤ **To set the amplitude**

1. Tap the **Amplitude** button at the bottom of the screen. A dialog box displays.

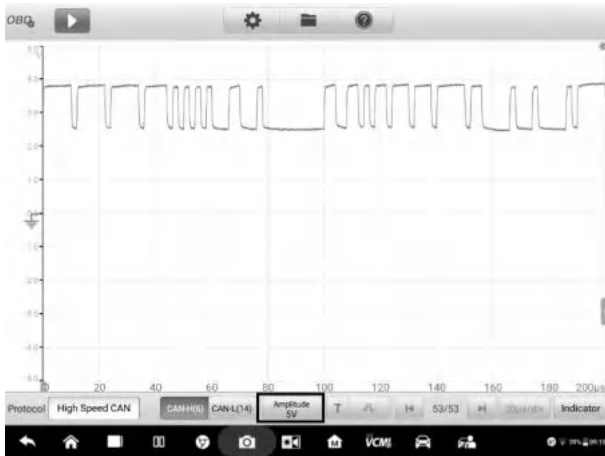

Figure 7-19 Sample Amplitude Button Screen

2. Select the appropriate amplitude for the protocol.



Figure 7-20 Sample Amplitude Setting Screen

3. Tap the **X** icon to close the dialog box.

● **Trigger**

The trigger feature is used to filter and capture specified waveform data.

According to the trigger setting condition, the trigger waveform will be captured when the signal meets the trigger condition. When capturing waveforms, you can manually set the trigger conditions. When the device is capturing the signal, tap the left column of the **Trigger** button to activate the trigger function. A trigger point displays as a blue point.

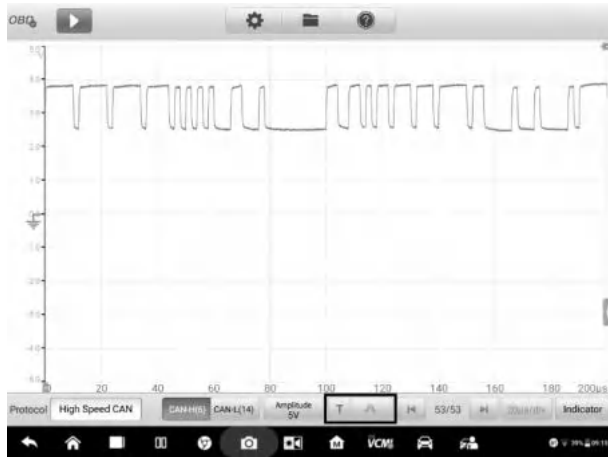

Figure 7-21 Sample Trigger Button Screen

The edge trigger is one of the most common trigger modes and is activated when voltage rises above or falls below a preset threshold. This trigger type allows you to configure the trigger mode, threshold, trigger channel and pulse direction settings. Tap **Done** to save the settings or tap **Cancel** to exit without saving.

When the device is capturing the signal, tap the right column of the **Trigger** button to open the trigger settings dialog box.



Figure 7-22 Sample Trigger Settings Screen

Trigger Mode

Three trigger modes are available: **None, Auto and Repeat.**



Figure 7-23 Sample Trigger Mode Screen

The table below offers brief description of each trigger mode.

Table 7-3 Trigger Mode Table

Trigger Mode	Description
None	In this trigger mode, the oscilloscope can continuously capture data, without waiting for a trigger event.
Auto	In this trigger mode, the oscilloscope will wait for a trigger before capturing data. It can automatically update after a short period, even if the signal does not cross the trigger point.
Repeat trigger	In this trigger mode, the oscilloscope waits until a trigger event occurs. If there is no trigger event, nothing will be displayed on the screen.

Channel

Select the applicable trigger channel from the dropdown menu. The selected channel is the communication line that the device monitors for the trigger condition.

Pulse Direction

Two pulse direction settings are available: **Rise** and **Fall**.



Figure 7-24 Sample Pulse Direction Screen

- ✧ **Rising Edge Trigger** - Indicates trigger is turned on to start the trace on the rising edge of the waveform.
- ✧ **Falling Edge Trigger** – Indicates trigger is turned on to start the trace on the falling edge of the waveform.

Threshold

The **Threshold** allows you to set the voltage threshold for the trigger.

- ✧ To precisely position the trigger point, input the value in the Threshold field in the trigger settings dialog box.
- ✧ To roughly position the trigger point, drag the trigger point to a desired position.
- **To configure the trigger settings**
 1. Tap the right column of the **Trigger** button to open the trigger settings dialog box.
 2. Select the trigger mode, trigger channel and pulse direction in the dropdown list.
 3. Input the value in the Threshold field in the trigger settings dialog box.
 4. Tap **Done** to save settings or tap **Cancel** to exit without saving.
- **Buffer**

The waveform buffer shows which signal waveform is displayed on the current screen and how many signal waveforms are captured and stored in the buffer memory.

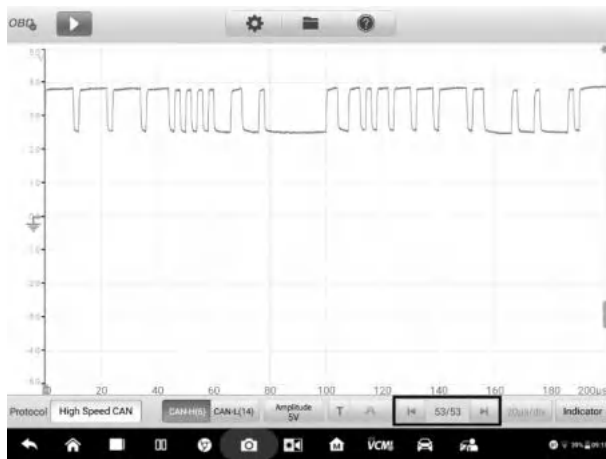





Figure 7-25 Sample Buffer Screen

The device can capture and store waveforms. You can select a waveform from the waveform buffer by tapping the **Previous** or **Next** button.

Name	Button	Description
Previous		Tap to display the previous waveform in the buffer.

Name	Button	Description
Buffer Index		Shows which waveform is currently being displayed and how many waveforms are in the buffer.
Next		Tap to display the next waveform in the buffer.

- **Time Base**

The time base controls the time interval across the device display. Tap the **Time Base** button at the bottom to open the setting dialog box.

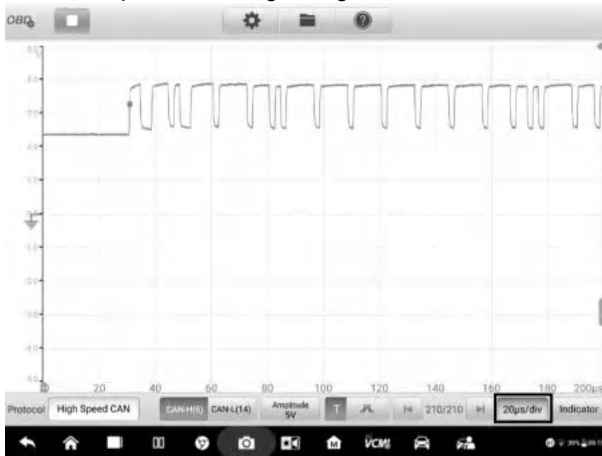

Figure 7-26 Sample Time Base Screen 1



Figure 7-27 Sample Time Base Screen 2

Continuous Mode: if the time base is set to more than or equal to 200ms/div, the device switches to the continuous mode. In this mode, the device updates the trace continuously as each capture progresses, rather than waiting for a complete capture before updating the trace.

- **Indicator Button**

In the lower corner of the screen, you can enter the Indicator Mode by tapping the **Indicator** button.

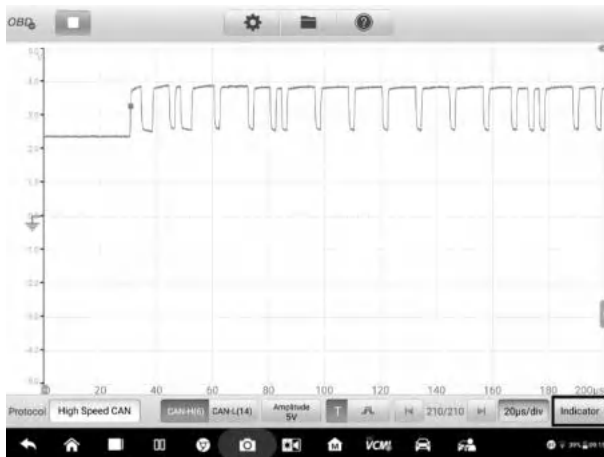

Figure 7-28 Sample Indicator Button Screen

7.4.6 Troubleshooting

If the VCM device cannot communicate with the MaxiSys Tablet:

- Ensure the VCM device is properly connected to the MaxiSys Tablet via Wi-Fi or with the supplied USB cable.
- Ensure the pin number is set properly.
- Ensure the ignition is in the Key **ON** position.
- Restart tablet and reconnect the VCM if communication continues to fail.

7.4.7 Glossary

Vehicle Bus

A vehicle bus is a specialized internal communications network that interconnects components inside a vehicle (e.g., automobile, bus, train, industrial or agricultural vehicle,

ship, or aircraft). Protocols include Controller Area Network (CAN), Local Interconnect Network (LIN) and others.

CAN Bus

A Controller Area Network (CAN bus) is a robust vehicle bus standard designed to allow microcontrollers and devices to communicate with each other in applications without a host computer.

SAE International

Initially established as the Society of Automotive Engineers, is a U.S.-based, globally active professional association and standards developing organization for engineering professionals in various industries. Principal emphasis is placed on transport industries such as automotive, aerospace, and commercial vehicles.

SAE J1708

SAE J1708 is a standard used for serial communications between ECUs on a heavy duty vehicle and also between a computer and the vehicle. With respect to Open System Interconnection model (OSI), J1708 defines the physical layer. Common higher layer protocols that operate on top of J1708 are SAE J1587 and SAE J1922. The protocol is maintained by SAE International.

SAE J1939

Society of Automotive Engineers standard SAE J1939 is the vehicle bus recommended practice used for communication and diagnostics among vehicle components. It is used in the commercial vehicle area for communication throughout the vehicle, with the physical layer defined in ISO 11898.

J1850

Defines a serial data protocol. There are two variants- 10.4 Kbit/s (single wire, VPW) and 41.6 Kbit/s (two wire, PWM). Mainly used by US manufacturers, also known as PCI (Chrysler, 10.4 Kbit/s), Class 2 (GM, 10.4 Kbit/s), and SCP (Ford, 41.6 Kbit/s).

OBD

On-board diagnostics (OBD) is an automotive term referring to a vehicle's self-diagnostic and reporting capability. OBD systems give the vehicle owner or repair technician access to the status of the various vehicle engine systems.

OBD-II diagnostic connector

The OBD-II DLC (post-1996 vehicles) is usually located under the instrument panel on the driver side, though there are several exceptions. The SAE J1962 specification provides for two standardized hardware interfaces, called type A and type B. Both are female, 9-pin (2x8), D-shaped connectors, and both have a groove between the two rows of pins.

DLC

The data link connector (DLC) is the multi-pin diagnostic connection port for automobiles, trucks, and motorcycles used to interface a scan tool with the control modules of a given vehicle and access on-board diagnostics and live data streams.

8 Data Manager

The Data Manager application allows you to store, print, and review the saved files, manage the workshop information, customer information records and keep test vehicle history records.



Selecting the Data Manager application opens the file system menu. There are eight main functions available.







Figure 8-1 Sample Data Manager Main Screen

The table below briefly describes each of the function buttons in the Data Manager application.

Table 8-1 Buttons in Data Manager

Name	Button	Description
Vehicle History		Tap to review the diagnostic history record.
Workshop Information		Tap to edit the information of workshops.
Customer		Tap to create a new customer account file.

Name	Button	Description
Image		Tap to review the screenshots
PDF		Tap to review the diagnostic reports.
Review Data		Tap to review the recorded data.
Uninstall Apps		Tap to uninstall applications.
Data Logging		Tap to review the communication data and ECU information of the test vehicle. The saved data can be reported and sent to the technical center via the internet.

8.1 Vehicle History

This function stores records of test vehicle history, including vehicle information and the retrieved DTCs from previous diagnostic sessions. Test information is summarized and displayed in an easy-to-read table listing. The Vehicle History also provides direct access to the previously tested vehicle and allows you to directly restart a diagnostic session without needing to perform auto or manual vehicle selection.

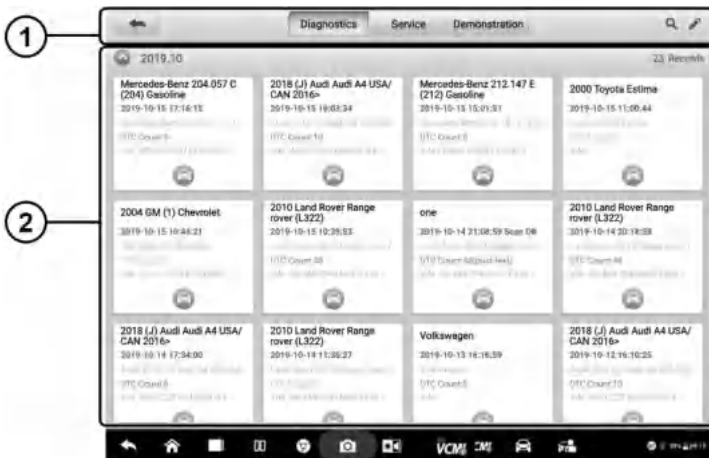

Figure 8-2 Sample Vehicle History Screen

1. Top Toolbar Buttons – navigation and application controls.

2. Main Section – displays all the vehicle history records.

➤ **To activate a test session for the recorded vehicle**

1. Tap **Data Manager** on the MaxiSys Job Menu.
2. Select **Vehicle History** to open the screen. Tap **Diagnostics** or **Service** to select diagnostic test records or service test records.
3. Tap **Diagnostics** icon at the bottom of the thumbnail of a vehicle record item.
4. The Diagnostics screen of the vehicle displays and a new diagnostic session is activated, see [Diagnostics](#) for detailed instructions on vehicle diagnostic operations. Or,
5. Select a vehicle thumbnail to select record. A Historical Test record sheet displays. Review the recorded information of the test vehicle, and tap the **Diagnostics** button on the upper right corner to continue diagnostics.

8.1.1 Historical Test Record

The Historical Test is a detailed data form of the tested vehicle, which includes general vehicle information, service record, customer information, and the diagnostic trouble codes retrieved from the previous test sessions. Technician Notes will also display if present.

 **NOTE**

The MaxiSys tablet must establish connection to the VCMII device to restart test sessions on the previously tested vehicles.

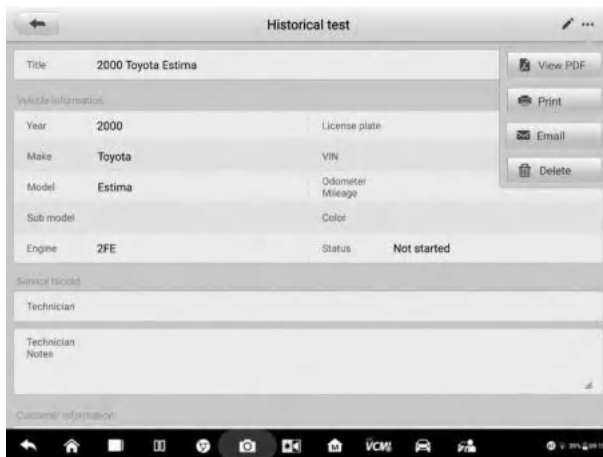

Figure 8-3 Sample Historical Test Record Sheet

➤ **To edit the Historical Test record**

1. Tap **Data Manager** on the MaxiSys Job Menu.
2. Select **Vehicle History**.
3. Select the specific vehicle history record thumbnail from the main section. The Historical Test record will display.
4. Tap **Edit** (a pen icon) to start editing.
5. Tap each item to input information or attach files or images.

 **NOTE**

The vehicle VIN, license number and customer account information are correlated by default. Vehicle records will automatically be correlated using this vehicle and customer identification.

6. Tap **Add to Customer** to correlate the Historical Test record sheet to an existing customer account, or add a new associated account to be correlated with the test vehicle record. See [Customer](#) on page 257 for more information.
7. Tap **Done** to save the updated record, or tap **Cancel** to exit without saving.

8.2 Workshop Information

The Workshop Information form allows you to input, edit, and save the detailed workshop information, such as shop name, address, phone number and other remarks, which, when printing vehicle diagnostic reports and other associated test file, will display as the header of the printed documents.

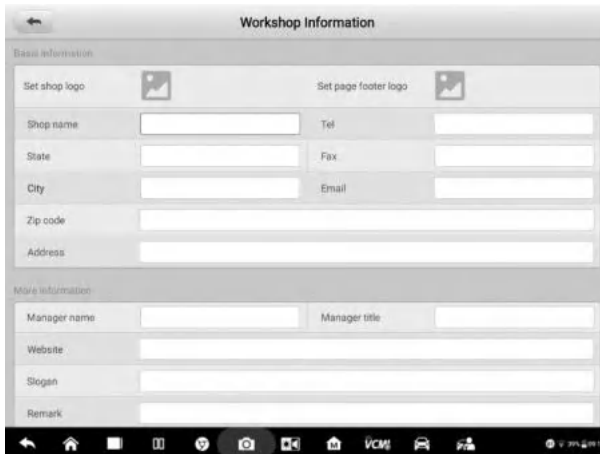

Figure 8-4 Sample Workshop Information Sheet

- **To edit the Workshop Information sheet**
 1. Tap the **Data Manager** application on the MaxiSys Job Menu.
 2. Select **Workshop Information**.
 3. Tap on each field to input the appropriate information.
 4. Tap **Done** to save the updated workshop information record, or tap **Cancel** to exit without saving.

8.3 Customer

The Customer function allows you to create and edit customer accounts. It helps you to save and organize all customer information accounts that are correlated with the associated test vehicle history records.

- **To create a customer account**
 1. Tap the **Data Manager** application on the MaxiSys Job Menu.
 2. Select **Customer**.
 3. Tap the **Add a customer** button. An empty information form displays, tap each field to input the appropriate information.

NOTE

The items that must be filled are indicated as required fields.

4. Some customers may have more than one vehicle for service; you can always add new vehicle information to the account. Tap **Add New Vehicle Information**, and then fill in the vehicle information. Tap the  button to cancel.
 5. Tap **OK** to save the account, or tap **Cancel** to exit without saving.
- **To edit a customer account**
 1. Tap **Data Manager** on the MaxiSys Job Menu.
 2. Select **Customer**.
 3. Select a customer account by tapping the corresponding name card. A Customer Information record displays.
 4. Tap **Edit** on the top toolbar to start editing.
 5. Tap on the input field to edit or amend information, and enter updated information.
 6. Tap **Complete** to save the updated information, or tap **Cancel** to exit without saving.
 - **To delete a customer account**

1. Tap **Data Manager** on the MaxiSys Job Menu.
2. Select **Customer**.
3. Select a customer account by tapping the corresponding name card. A Customer Information record displays.
4. Tap **Edit** on the top toolbar to start editing.
5. Tap **Delete** button on the top of the screen. A reminder message displays.
6. Tap **OK** to confirm the command, and the account is deleted. Tap **Cancel** to cancel the request.

8.4 Image

The Image section is a PNG database containing all captured screenshots.

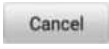





Figure 8-5 Sample Image Database Screen

1. Toolbar Buttons – used to edit, print and delete the image files. See [Table 8-2 Toolbar Buttons in PNG Database](#) on page 258 for detailed information.
2. Main Section – displays the stored images.

Table 8-2 Toolbar Buttons in PNG Database

Name	Button	Description
Back		Return to the previous screen.
Enter Search		Tap to enter the search page.

Name	Button	Description
Enter Edit		Tap to display the editing toolbar to select, delete, print, or email the image(s).
Cancel		Tap to close the editing toolbar or cancels file search.
Search		Quickly searches the image by entering the time of the screenshot.
Print		Tap to print the selected image.
Delete		Tap to delete the selected image.
Email		Tap to send the selected image to an email.

➤ **To edit/delete image(s)**

1. Select **Data Manager** from the MaxiSys Job Menu.
2. Select **Image** to access the PNG database.
3. Tap **Edit** on the top right corner of the window. The editing screen displays.
4. Select the image(s) you want to edit by tapping the check box at the bottom right corner of the image.
5. Tap **Delete** icon to delete the selected images or delete all images. Tap **Print** icon to print the selected image(s). Tap **Email** icon to send the selected image(s) to an email.

8.5 PDF Files

The PDF section stores and displays all PDF files of saved data. After entering the PDF database, select a PDF file to view the stored information.

This section uses the standard Adobe Reader application for file viewing and editing. Please refer to the associated Adobe Reader manual for more detailed instructions.

8.6 Review Data

The Review Data section allows you to playback the recorded data frames of live data streams.

On the Review Data main screen, select a record file to playback.



Figure 8-6 Sample Data Playback Screen

1. Main Section – displays the recorded data frames.
2. Navigation Toolbar – allows you to manipulate data playback.

Use the Navigation Toolbar buttons to playback the record data from frame to frame.

Tap **Back** to exit data playback.

8.7 Uninstall Apps

This section allows you to manage the firmware applications installed on the MaxiSys Diagnostics System. Selecting this section opens a managing screen, on which you can check all the available vehicle diagnostic applications.

Select the vehicle firmware you want to delete by tapping on the car brand icon, the selected item will display a blue check mark at the upper right corner. Tap the **Delete** button on the top bar to delete the firmware from the system database.

8.8 Data Logging

The Data Logging section allows you to launch Support platform directly to view all records of all feedback or not feedback (saved) data loggings on the diagnostic system. For more details, please refer to [Data Logging](#) on Page 277.

9 Settings

Access the Settings menu to adjust default setting and view information about the MaxiSys system. The following options are available for the MaxiSys system settings:

- Unit
- Language
- Printing Settings
- Notification Center
- Auto Update
- ADAS Registration
- Vehicle List
- Country Code
- System Settings
- About

9.1 Operations

This section describes the operation procedures for the settings.

9.1.1 Unit

This option allows you to adjust the measurement unit for the diagnostic system.

➤ **To adjust the unit setting**

1. Tap the **Settings** application on the MaxiSys Job Menu.
2. Tap the **Unit** option on the left column.
3. Select the appropriate measurement unit, Metric or English. A check mark will display to the right of the selected unit.
4. Tap the **Home** button on the top left corner to return to the MaxiSys Job Menu. Or select another setting option for the system setup.

9.1.2 Language

This option allows you to adjust the display language for the MaxiSys system.

➤ To adjust the language setting

1. Tap the **Settings** application on the MaxiSys Job Menu.
2. Tap the **Language** option on the left column.
3. Select the appropriate language. A check mark will display to the right of the selected language.
4. Tap the **Home** button on the top left corner to return to the MaxiSys Job Menu. Or select another setting option for the system setup.

9.1.3 Printing Settings

Printing Setting

This option allows you to print from the tablet to a network printer via a computer.

➤ To setup the printer connection

1. Tap **Settings** on the MaxiSys Job Menu.
2. Tap **Printing Settings** on the left column.
3. Tap **Print via Network** to activate the printing function, which enables the device to send files to the printer through the PC via Wi-Fi or Ethernet connection.
4. Tap **Home** on the top left corner to return to the MaxiSys Job Menu. Or select another setting option for the system setup.

Printing Operations

➤ To install the MaxiSys Printer driver program

1. Download **Maxi PC Suite** from www.autel.com > *Support* > *Downloads* > *Autel Update Tools*, and install to your windows-based computer.
2. Double click on **Setup.exe** item.
3. Select the installation language and the wizard will load.
4. Follow the instructions on the screen and Click **Next** to continue.
5. Click **Install** and the printer driver program will be installed onto the computer.
6. Click **Finish** to complete the installation.

NOTE

The MaxiSys Printer runs automatically after the installation.

This section describes how to receive file from the MaxiSys tablet and perform printing through the computer:

➤ **To perform printing through the computer**

1. Make sure the tablet is connected to the computer network, either via Wi-Fi or LAN, before printing.
2. Run the **MaxiSys Printer** program on the computer.
3. Click **Test Print** to make sure the printer is working successfully.
4. Tap the **Print** button on the toolbar of the tablet. A test document will be sent to the computer.
 - If the **Auto Print** option in the MaxiSys Printer is selected, the MaxiSys Printer will print the received document automatically.
 - If the **Auto Print** option is not selected, click **Open PDF File** button to view files. Select the file(s) to print and click **Print**.

 **NOTE**

Make sure the computer installed with the Printing Services program is connected to a printer.

9.1.4 Notification Center

This option allows you to turn the Notification Center function on or off. The Notification Center function configures the MaxiSys tablet to receive regular online messages from the server for system update notifications or other service information via the Internet. It is highly recommended that the Notification setting be on at all times so as not to miss news of updates or important service messages. Internet access is required for receiving online messages.

➤ **To enable the Notification Center function**

1. Tap **Settings** on the MaxiSys Job Menu.
2. Tap **Notification Center** on the left column.
3. Tap **ON/OFF** to enable or disable the Notifications function. If the function is enabled the button displays blue, or if disabled the button displays gray.
4. Tap **Home** on the top left corner to return to the MaxiSys Job Menu. Or select another setting option for the system setup.

When the Notification Center function is turned on, and new messages are received by the MaxiSys device, a notification message displays on the MaxiSys Job Menu. Press

on the message bar and drag it down to display a list of received messages. Slide the list up or down to view additional messages if present.

Tap a specific message to launch the corresponding application. For example, if you tap on an Update notification message, the Update application will be launched.

9.1.5 Auto Update

This option allows you to set the specific time for updating software automatically. There are three update options: OS Update, MaxiSys Update and Vehicle Update.

Tap **ON/OFF** to enable Auto Update. The button displays blue if Auto Update is enabled and displays gray if the Auto Update is disabled. Set the time of the day for updating. If a specific time is set, the selected software will be automatically updated at this specific time.

9.1.6 ADAS Registration

➤ To activate the MaxiSys ADAS Calibration

1. Confirm the registered MaxiSys has active updates.
2. Select **Settings** on the MaxiSys Job Menu.
3. Click on **ADAS Registration**.
4. Scan the QR code on the ADAS frame to bind, or manually input frame serial number when QR code is not available.
5. Enter the validation code from the ADAS Calibration Card.
6. The system will be reset and the main screen will display once registration has been completed.

9.1.7 Vehicle List

This option allows you to sort the vehicles either by alphabetic order or by frequency of use.

➤ To adjust the vehicle list setting

1. Tap the **Settings** application on the MaxiSys Job Menu.
2. Tap **Vehicle List** on the left column.
3. Select the required sort type. A check mark will display to the right of the selected language.
4. Tap the **Home** button in the top left corner to return to the MaxiSys Job Menu.

Or select another setting option for system setup.

9.1.8 Country Code

This function provides Wi-Fi channel options for different country regions to ensure reliable and stable Wi-Fi communication. Please connect the tablet with VCMI device before making adjustment.

➤ To adjust the country code setting

1. Tap the **Settings** application on the MaxiSys Job Menu.
2. Tap the **Country Code** option on the left column.
3. Select the appropriate country region. A message displays to confirm your selection.
4. Tap the **Home** button on the top left corner to return to the MaxiSys Job Menu. Or select another setting option for the system setup.

NOTE

If the tablet can NOT find the VCMI device via Wi-Fi connection after setting the country code, please use the USB or Bluetooth connection to retry.

9.1.9 System Settings

This function provides you with direct access to the Android system setting interface, where you can adjust various system settings for the Android system platform, regarding wireless and networks settings, various device settings such as sound and display, as well as system security settings, and check related information about the Android system. Refer to Android documentation for additional information.

9.1.10 About

The About function provides information of the MaxiSys diagnostic device including the product name, version, hardware, and serial number.

➤ To check the MaxiSys product information in About

1. Tap the **Settings** application on the MaxiSys Job Menu.
2. Tap the **About** option on the left column. The product information screen displays on the right.
3. Tap the **Home** button on the top left corner to return to the MaxiSys Job Menu, or select another setting option for the system setup, after viewing.

10 Update

The internal programming of the MaxiSys Diagnostic System, known as the firmware, can be updated using the Update application. Firmware updates increase the MaxiSys applications' capabilities, typically by adding new tests, new models, or enhanced applications to the database.

The display device automatically searches for available updates for all of the MaxiSys components when it is connected to the Internet. Any updates that are found can be downloaded and installed on the device. This section describes installing an update to the MaxiSys Diagnostic System firmware. A notification message displays if an update is available when the Notifications function is enabled in the Settings application (See [Notification Center](#) on page 263).



Figure 10-1 Sample Update Screen

1. Navigation and Controls
 - Home Button – returns to the MaxiSys Job Menu.
 - Update All – available updates for all tablet systems
 - Show Recent – shows the recent updates
 - Search Bar – searches specific update item by inputting the file name, for example: a specific vehicle manufacturer.
2. Status Bar

- Left Side – displays the MaxiSys device model information and serial number
 - Right Side – displays an update progress bar indicating the completion status
3. Main Section
- Left Column – displays vehicle logos and update firmware version information.
 - Middle Column – displays a brief introduction about the new changes to the firmware operation or capabilities. Tap ⓘ button to display an information screen to view more details, and tap the dim area around to close the window.
 - Right Column – according to the operation status of each firmware item, the button displays differently.
 - a) Tap **Update** to update the selected item.
 - b) Tap **Pause** to suspend the updating procedure.
 - c) Tap **Continue** to go on updating the suspended update.

➤ **To update the firmware**

1. Power up the tablet, and ensure that it is connected to a power source and has a steady Internet connection.
2. Tap the **Update** application button from the MaxiSys Job Menu; or tap the update notification message when received. The Update application screen displays.
3. Check all available updates:
 - If you decide to update all the items, tap the **Update All** button.
 - If you only want to update some individual items, tap the **Update** button on the right column of the specific item. This option is highly recommended to ensure updates are performed correctly, especially if unsure of the speed and stability of your shops Internet connection.
4. Tap the **Pause** button to suspend the updating process. Tap **Continue** to resume the update and the process will continue from the pause point.
5. When the updating process is completed, the firmware will be installed automatically. The new version will replace the older version.

11 VCMi Manager

VCMi Manager is for connecting the MaxiSys MS909 tablet with a VCMi device through Wi-Fi or Bluetooth. This application allows you to pair the tablet with the VCMi device and to check the communication status. You can either build the connection via the Bluetooth or Wi-Fi, of which the latter is more stable and faster in speed for module operation.



Figure 11-1 Sample VCMi Manager Screen

- 1. Connection Mode** – three connection modes are available. The connection status displays adjacent to each mode.
 - Wi-Fi Connection – when connected to a wireless device, the connection state displays as Connected, otherwise it displays as Not Connected.
 - BT Pairing – when paired to a wireless device, the connection state displays as Connected; otherwise it displays as Not Connected.
 - Update (for VCMi software only) – updates VCMi software via Internet through the MaxiSys tablet networking using USB connection.
 - Select a connection mode to manage and set up connection.
- 2. Settings** – this section allows you to manage wireless pairing or set up network connection.
 - Wi-Fi Setting - searches and displays the type and partial serial number of all

devices available for Wi-Fi connection.

- BT Setting – searches and displays the type and partial serial number of all devices available for pairing. Tap a device to start pairing. The BT status icon displays the received signal strength for the device.
- Ethernet Setting – allows you to perform network configuration.

11.1 Wi-Fi Connection

Wi-Fi Connection is an advanced function for quick linkage with VCMI. Since Wi-Fi connection supports 5G, the MaxiSys Ultra tablet and VCMI share a faster and more stable connection when using this communication method. The tablet can be operated up to 50 meters away from the VCMI device when connected to the vehicle.

The Wi-Fi connection is an ideal communication mode when using the oscilloscope measurement function, See [Oscilloscope](#) for details.



Figure 11-2 Sample Wi-Fi Connection Screen

- **To connect the VCMI device with the tablet via Wi-Fi connection**
1. Power on the tablet.
 2. Connect the 26-pin end of the data cable to the VCMI's vehicle data connector.
 3. Connect the 16-pin end of the data cable to the vehicle data link connector (DLC).
 4. Tap **VCMI Manager** on the MaxiSys Job Menu of the tablet.
 5. Select **Wi-Fi** from the connection mode list.
 6. Swipe the Wi-Fi toggle to turn it **ON**. Tap **Refresh** at the top right corner. The

device will start to search for available units.

7. Depending on the VCMi type you use, the device name may display as Maxi suffixed with a serial number. Select the appropriate device for connection.
8. When connection is established, the connection status displays as Connected.
9. The VCMi button on the system Navigation bar at the bottom of the screen displays a green Wi-Fi icon, indicating the tablet is connected to the VCMi device.
10. To disconnect the device, tap the connected device listing again.
11. Tap **Back** on the top left to return to the MaxiSys Job Menu.

NOTE

To ensure quick connection, please perform this operation in a steady network environment.

11.2BT Pairing

BT Paring is the basic way for wireless connection. The VCMi device needs to be either connected to a vehicle or to an available power source, so that it is powered up during the synchronization procedure. Make sure the tablet has a charged battery or is connected to an AC/DC power supply.



Figure 11-3 Sample BT Pairing Screen

- **To pair the VCMi device with the tablet**
 1. Power on the tablet.
 2. Connect the 26-pin end of the data cable to the VCMi's vehicle data connector.

3. Connect the 16-pin end of the data cable to the vehicle data link connector (DLC).
4. Tap **VCMi Manager** on the MaxiSys Job Menu of the tablet.
5. Select **BT**, short for Bluetooth, from the connection mode list.
6. Swipe the Bluetooth toggle to turn it **ON**. Tap **Scan** at the top right corner. Now the device starts searching for available pairing units.
7. Depending on the VCMi type you use, the device name may display as Maxi suffixed with a serial number. Select the required device for pairing.
8. When paired successfully, the connection status displays as Connected.
9. Wait a few seconds, and the VCMi button on the system Navigation bar at the bottom of the screen displays a green check mark, indicating the tablet is connected to the VCMi device.
10. To disconnect the device, tap the connected device listing again.
11. Tap **Back** on the top left to return to the MaxiSys Job Menu.

NOTE

A VCMi device can be paired to only one tablet at a time, and once it's been paired, the device will not be discoverable by any other unit.

11.3 Update

The Update module provides the [latest update](#) for the MaxiSys Ultra tablet. Before updating the VCMi software, please make sure the tablet network connection is stable.



Figure 11-4 Sample VCMI Update Screen

➤ **To update the VCMI device software**

1. Power on the tablet.
2. Connect the VCMI device to the tablet via USB.
3. Tap **VCMI Manager** on the MaxiSys Job Menu of the tablet.
4. Select **Update** from the connection mode list.
5. The current version and the latest version of the software will display. Tap **Update Now** to update the VCMI software.

12 ADAS

Advanced Driver Assistance Systems (ADAS) is an array of vehicle systems that aid the driver either through passive alerts or by active control of the vehicle to drive safer and with greater awareness and precision.

Cameras, sensors, ultrasound, radar and LIDAR are some of the systems used to capture the driving environment data, including travelling or static vehicles position, pedestrian location, road sign, driving lane and intersection detection, road (curves) and driving conditions (poor visibility or evening driving), use that information to instruct the vehicle to take its predetermined action. Cameras, sensors and sensing systems are typically located in front and rear bumpers, windshield, front grill and side and rear view mirrors.

Autel ADAS Calibration Tool provides comprehensive and precise ADAS calibration.

1. Covers many vehicle makes, including Benz, BMW, Audi, Volkswagen, Porsche, Infiniti, Lexus, GM, Ford, Volvo, Toyota, Nissan, Honda, Hyundai, and Kia.
2. Supports the calibration of multiple driver assistant systems, including Adaptive Cruise Control (ACC), Night Vision System (NVS), Lane Departure Warning (LDW), Blind Spot Detection (BSD), Around View Monitoring (AVM), Rear Collision Warning (RCW) and Heads-up Displays (HUD).
3. Supplies graphic illustrations and step-by-step instructions.
4. Provides demos to guide the technician through the calibration.



Figure 12-1 Sample ADAS Introduction Screen

13 Support

This application launches the Support platform which synchronizes Autel's online service base station with the MaxiSys tablet. In order to synchronize the device to your online account, you need to register the product through the Internet when you use it for the first time. The Support application is connected to Autel's service channel and online communities that provides the quickest way for problem solutions, allowing you to submit complaints or send help requests to obtain direct service and support.

13.1 Product Registration

In order to get access to the Support platform and obtain update and other services from Autel, you are required to register the MaxiSys Diagnostic Device the first time you use it.

➤ **To register the diagnostic device**

1. Visit the website: <http://pro.autel.com>.
2. If you have an Autel account, Sign In with your account ID and password.
3. If you are a new member to Autel, click on the **Create Autel ID** button on the left side to create an ID.
4. Enter the required information in the input fields, and click **Get Verification Code** button to get the verification code for email validation.
5. The online system will automatically send a verification code to the registered email address. Input the code in the Verification Code field and fill in the other input fields, read through Autel's Terms and Conditions and click on **Agree**, and then click **Create Autel ID** at the bottom. A product registration screen will display.
6. The device's serial number and password is located in the [About](#) section of the Settings application on the tablet.
7. Select your product model, enter the product serial number and password on the Product Registration screen, and tap **Submit** to complete the registration procedure.

13.2 Support Screen Layout

The Support application interface is navigated by the Home Button on the top navigation bar.

- Home Button – returns to the MaxiSys Job Menu.



Figure 13-1 Sample Support Application Screen

The main section of the Support screen is divided into two sections. The narrow column on the left is the main menu; selecting one subject from the main menu displays the corresponding functional interface on the right.

13.3 My Account

The My Account screen displays the comprehensive information of the user and the product, which is synchronized with the online registered account, including User Info, Device Info, Update Info and Service Info.

13.3.1 Personal Info

The User Info and Device Info are both included under the Personal Info section.

- User Info – displays detailed information of your registered online Autel account, such as your Autel ID, Name, Address and other contact information.
- Device Info – displays the registered product information, including the Serial Number, Registration Date, Expire Date, and Warranty Period.

13.3.2 Update Info

The Update Info section displays a detailed list of the product's software update history, including the product serial number, software version or name, and the update time.

13.3.3 Service Info

The Service Info section displays a detailed record list of the device's service history information. Every time the device has been sent back to Autel for repair, the device's serial number and the detailed repair information, such as the fault type, changed components, or system reinstallation will be recorded and updated to the associated online product account that will be synchronized to the Service Info section.

13.4 Complaint

The Complaint screen allows you to establish a new complaint case, as well as to view historical complaint records.

13.4.1 Screen Layout

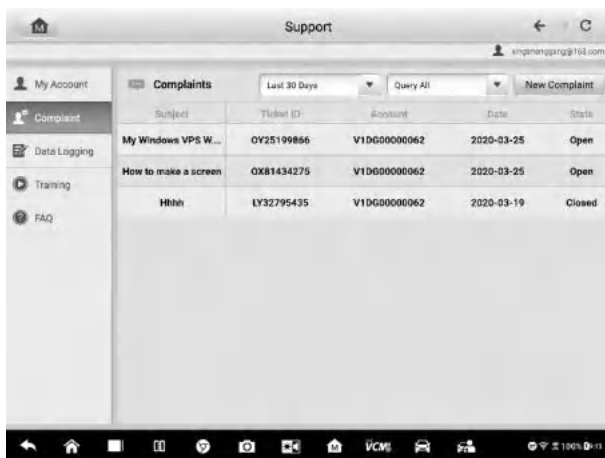

Figure 13-2 Sample Complaint Screen

Complaint List

The complaint list normally displays all the complaint records and their status by default. The summary information for each complaint item includes the Subject Name, Ticket ID, User's Account ID, Date, and the Case Status.

There are two kinds of case status:

- Open – indicates the complaint case has been started but not processed yet.
- Closed – indicates the complaint case has been processed, solved, and ended.

➤ **To establish a new complaint session**

1. Register the product online.
2. Tap **Support** on the MaxiSys Job Menu. The device information is automatically synchronized with the online account.
3. Tap **Complaint** on the Main Menu.
4. Tap **New Complaint** at the upper right corner. A selection menu with a category of service channels displays.
5. Select your target service channel and click **Next** to continue. A standard complaint form displays, on which you are allowed to enter detailed information, such as personal information, vehicle information, and device information, you can also attach image or PDF files with the form.
6. Enter in each input field the appropriate information. To settle the complaint more efficiently, it is recommended to complete the form with as much detail as possible.
7. Select the required processing time on the last section according to the urgency of the case.
8. Tap **Submit** to send the completed form to Autel's online service center. The submitted complaints will be carefully read and handled by the service personnel.

13.5 Data Logging

The Data Logging section keeps records of all **Feedback** (submitted), **Not Feedback** (but saved) or **History** (up to the latest 20 test records) data loggings on the diagnostic system. The support personnel will receive and process the submitted reports through the Support platform. The solution will be sent back within 48 hours. You may continue to correspond with Support until the issue is resolved.

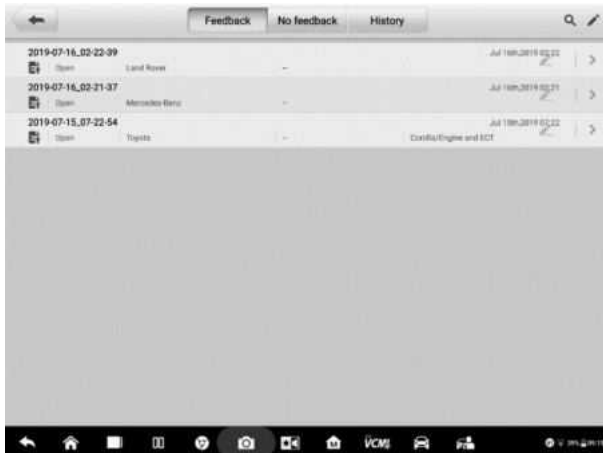

Figure 13-3 Sample Data Logging Screen

➤ **To make a reply in a Data Logging session**

1. Tap on the **Feedback** tag to view the list of submitted data loggings.
2. Select the latest message from Support.
3. Tap on the input field at the bottom of the screen, and enter your reply. Or tap the Audio button to record a voice message, or tap the camera button to take a screenshot.
4. Tap **Send** to deliver your message to Support.

13.6 Training

The Training section provides quick links to Autel's online video accounts. Select a video channel by language to see all available Autel online tutorial videos on such topics as product usage techniques and vehicle diagnostics practices.

13.7 FAQ Database

The FAQ section provides comprehensive references for all questions frequently asked and answered about the use of Autel's online member account, shopping and payment procedures.

- Account – displays questions and answers about the use of Autel's online user account.
- Shopping & Payment – displays questions and answers about online product purchase and payment methods or procedures.

14 Remote Desktop

The Remote Desktop application launches the TeamViewer Quick Support program, which is a simple, fast and secure remote control interface. You can use the application to receive ad-hoc remote support from Autel's support center, colleagues, or friends, by allowing them to control your MaxiSys tablet on their PC via the TeamViewer software.

14.1 Operations

If you think of a TeamViewer connection as a phone call, the TeamViewer ID would be the phone number under which all TeamViewer Clients can be reached separately. Computers and mobile devices that run TeamViewer are identified by a globally unique ID. The first time the Remote Desktop application is started, this ID is generated automatically based on the hardware characteristics and will not change.

Make sure the tablet is connected to the Internet before launching the Remote Desktop application, so that the tablet is able to receive remote support from the third party.

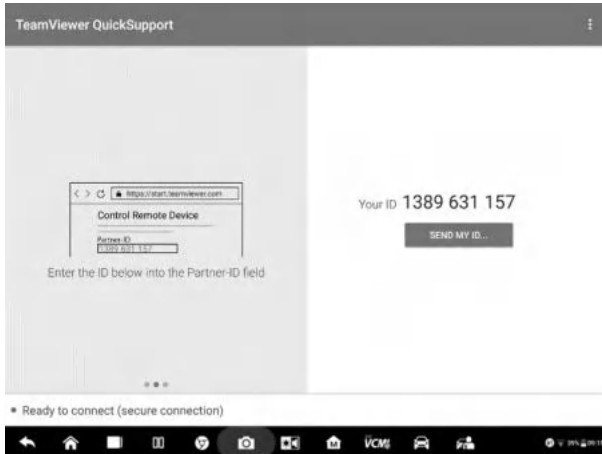

Figure 14-1 Sample Remote Desktop Screen

- **To receive remote support from a partner**
 1. Power on the tablet.
 2. Tap the **Remote Desktop** application on the MaxiSys Job Menu. The

TeamViewer interface displays and the device ID is generated and shown.

3. Your partner must install the Remote Control software to his/her computer by downloading the TeamViewer full version program online (<http://www.teamviewer.com>). Start the software on his/her computer at the same time, in order to provide support and take control of the tablet remotely.
4. Provide your ID to the partner, and wait for him/her to send you a remote control request.
5. A message displays to ask for your confirmation to allow remote control on your device.
6. Tap **Allow** to accept, or tap **Deny** to reject.

Refer to the associated TeamViewer documents for additional information.

15 Quick Link

The Quick Link application provides you with convenient access to Autel's official website and many other well-known sites in automotive service, which offers you abundant information and resources, such as technical help, knowledge bases, forums, training and expert consultations.

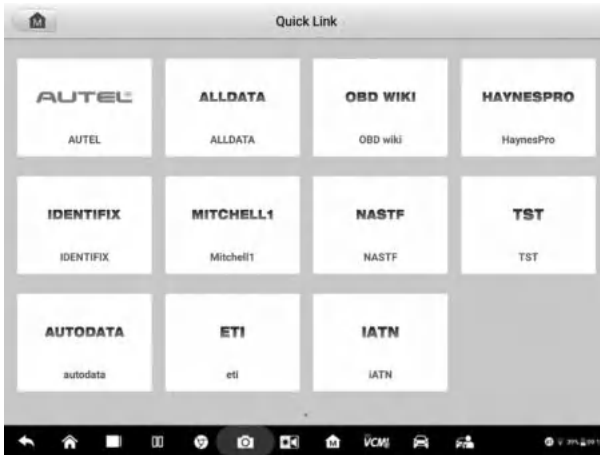

Figure 15-1 Sample Quick Link Screen

➤ **To open a quick link**

1. Tap **Quick Link** on the MaxiSys Job Menu. The Quick Link application screen displays.
2. Select a website thumbnail from the main section. The Chrome browser is launched and the selected website is opened.
3. Now you can start exploring the website!

16 MaxiViewer

The MaxiViewer allows you to search the functions supported by our tools and the version information. There are two ways of searching, either by searching the tool and the vehicle or searching the functions.

➤ **To search by the vehicle**

1. Tap the **MaxiViewer** application on the MaxiSys Job Menu. The MaxiViewer application screen displays.
2. Tap the tool name on the top left to drop down the tool list, tap the one you want to search.
3. Tap the vehicle brand, model, and year you want to search.

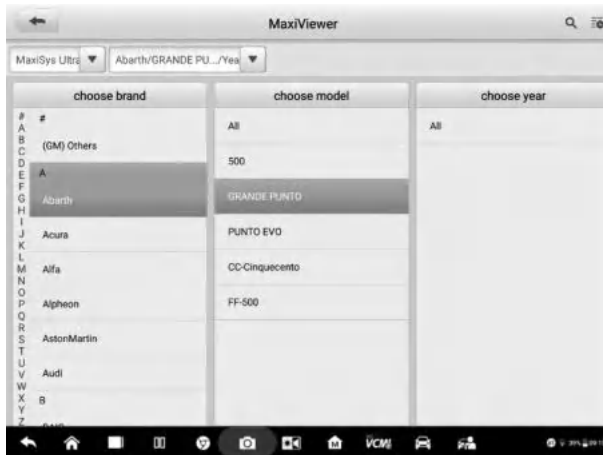

Figure 16-1 Sample MaxiViewer Screen 1

4. All the functions supported by the selected tool for the selected vehicle display within three columns, function, sub function, and version.



Figure 16-2 Sample MaxiViewer Screen 2

➤ **To search by the functions**

1. Tap the MaxiViewer application on the MaxiSys Job Menu. The MaxiViewer application screen displays.
2. Tap the tool name on the top left to drop down the tool list, tap the one you want to search.
3. Enter the function you want to search in the top right search box. The screen will display all vehicles that support this function, along with information such as the vehicles' year, system, capacity, type, function, sub-function, and version.

NOTE

Fuzzy search is supported, type in some part of the function-related keywords to find all the available information.

17 MaxiVideo

The MaxiVideo application configures the MaxiSys Diagnostic Device to operate as a digital video scope by simply connecting the tablet to a MaxiVideo Camera. This function allows you to examine difficult-to-reach areas normally hidden from sight, with the ability to record digital still images and videos, which offers you an economical solution to inspect machinery, facilities, and infrastructure in a safe and quick way.

WARNINGS & IMPORTANTS:

Follow these instructions to reduce the risk of injury from electric shock, entanglement and other causes and prevent tool damage.

- Do not place the imager head and cable into anything or anywhere that may contain a live electric charge or moving parts, which increases the risk of electric shock or entanglement injuries.
- Do not use the imager head cable to modify surroundings, clear pathways or clogged areas.
- When inspection is completed, carefully withdraw the imager head cable from the inspection area.
- The imager head cable is waterproof to a depth of 3m (10'), greater depths may cause leakage into the imager head cable, electric shock or tool damage.
- The working temperature of the imager head is between 32°F (0°C) and 113°F (45°C).

Check-Ups:

- ✓ **FOR AUTOMOBILES:** Ensure the automobile is not running during inspection. Metal and liquid under the hood may be hot. Don't get oil or gas on the imager head.
- ✓ **FOR PIPES:** If you suspect a metal pipe could contain an electric charge, have a qualified electrician to check the pipe before using.
- ✓ **FOR WALLS:** For inspecting the inside walls, be sure to shut off the circuit breaker to the whole house before using the tool.
- ✓ **WORK AREA:** Ensure the work area has sufficient light.

17.1 Additional Accessories

The MaxiVideo Camera and its fittings are the additional accessories. Both sizes (8.5 mm and 5.5 mm) of the imager head are optional and available for purchase along with the standard MaxiSys tool kit.

17.1.1 MaxiVideo Camera

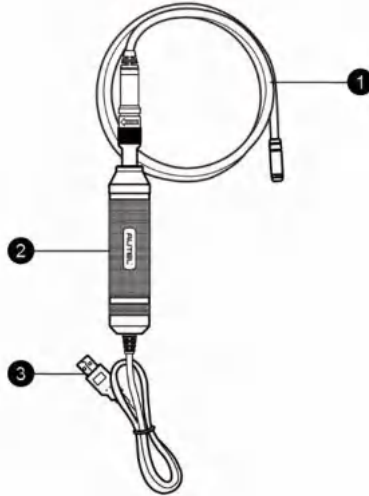

Figure 17-1 MaxiVideo Camera

1. Removable Imager Head Cable – connects to the tool when performing MaxiVideos for image and video viewing.
2. Handgrip – ergonomically designed handle for comfortable grips and agile operation.
3. USB Cable – connects the MaxiVideo Camera to MaxiSys tablet.

17.1.2 Imager Head Accessories

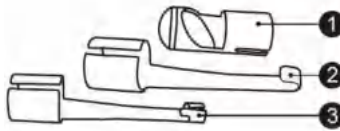

Figure 17-2 8.5mm Imager Head Accessories

1. Magnet – picks up small metal objects, such as dropped rings or screws.
2. Hook – unclogs obstacles and picks up wires in the pipes or confined areas.
3. Mirror – helps to look around corners and see the unreachable areas.

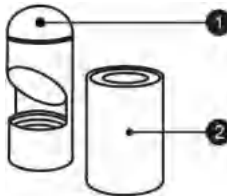

Figure 17-3 5.5mm Imager Head Accessories

1. Mirror – helps to look around corners and see the unreachable areas.
2. Magnet – picks up small metal objects, such as dropped rings or screws.

17.1.3 Accessory Assembly

17.1.3.1 For 8.5mm Imager Head

The three accessories, including the Magnet, Hook, and Mirror, can be attached to the Imager Head with the same manner described below:

1. Hold the accessory and the imager head.

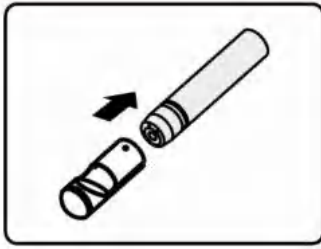

2. Slip the end of the accessory over the imager head and then fix the accessory.

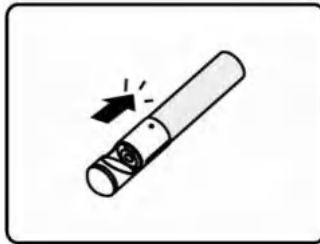

17.1.3.2 For 5.5mm Imager Head

The two accessories, including the Magnet and Mirror, can be attached to the Imager Head with the same manner described below:

1. Hold the accessory and the imager head.

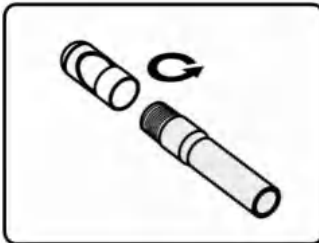

2. Screw the thread part of the accessory over the imager head to fix the accessory.



17.1.4 Technical Specifications

Table 17-1 Specifications

Item	Description
Optimal Viewing Distance	1" to 14" (2.54cm to 35.56cm) with 8.5mm diameter imager head 3/8" to 12" (0.95cm to 30cm) with 5.5mm diameter imager head
Image Capture	JPG images (640x480) AVI videos (320 x 240)
Operating Temperature	Main Unit: 0°C to 55°C (ambient) Cable: -10°C to 70°C
Storage Temperature	-20°C to 75°C (ambient)
Waterproof	Imager head and cable to 1m
Weigh	0.3 kg with 8.5 mm diameter imager head 0.2 kg with 5.5 mm diameter imager head

17.2 Operations

Before opening the MaxiVideo application, the Imager Head Cable must be connected to the tablet through the USB port. Install the correct imager head accessories according to the specific needs.

 **NOTE**

When in operation, the imager head cable can be manipulated so as to better access confined or awkward spaces.

➤ **To take images using the MaxiVideo application**

1. Connect the Imager Head Cable to the USB port on the top side of the tablet.
2. If not already done, power up the tablet.
3. Tap the **MaxiVideo** application on the MaxiSys Job Menu. The MaxiVideo interface displays, showing a camera operating screen. The Imager head camera is used by default.
4. Select the **camera** icon at the lower right corner to take images.
5. Focus the image to be captured in the view finder by adjusting and properly locating the imager head cable.
6. Tap the blue ring on the screen. The view finder now displays the captured picture and auto-saves the taken photo.
7. Tap the thumbnail image on the top right corner of the screen to view the stored image, slide the screen left and right to view the images.
8. Tap on the selected image and the edit toolbar instantly displays.
9. Tap the corresponding button to **share or delete** an image.
10. Tap the **Back** or **Home** button on the Navigation bar at the bottom of the screen to exit the MaxiVideo application.

➤ **To record a video using the MaxiVideo application**

1. Connect the Imager Head Cable to the USB port on the top side of the tablet.
2. If not already done, power up the tablet.
3. Tap the **MaxiVideo** application on the MaxiSys Job Menu. The MaxiVideo interface displays, showing a camera operating screen. The Imager head camera is used by default.
4. Select the **Video** icon at the lower right corner to record a video.
5. Properly locate the imager head cable to focus the inspection scene for recording.
6. Tap the red ring on the operating screen to start recording.
7. Tap the red circle again to stop recording. The recorded video is automatically saved.
8. Tap the gallery icon at the bottom right corner to review all the recorded videos.
9. Select the corresponding button on the upper right corner to search or delete a video.

18 Maintenance and Service

To ensure that the tablet and the combined VCMI unit perform at their optimum level, we advise that the product maintenance instructions in this section are strictly followed.

18.1 Maintenance Instructions

The following shows how to maintain your devices, together with precautions to take.

- Use a soft cloth and alcohol or a mild window cleaner to clean the touch screen of the tablet.
- Do not use any abrasive cleansers, detergent, or automotive chemicals to the tablet.
- Keep the devices in dry conditions and within specified operating temperatures.
- Dry your hands before using the tablet. The touch screen of the tablet may not work if the touch screen is moist, or if you tap the touch screen with wet hands.
- Do not store the devices in humid, dusty or dirty areas.
- Check the housing, wiring, and connectors for dirt and damage before and after each use.
- Check the housing, wiring, and connectors for dirt and damage before and after each use.
- Do not attempt to disassemble your tablet or the VCMI unit.
- Do not drop or cause severe impact to the devices.
- Use only authorized battery chargers and accessories. Any malfunction or damage caused by the use of unauthorized battery charger and accessories will void the limited product warranty.
- Ensure that the battery charger does not come in contact with conductive objects.
- Do not use the tablet beside microwave ovens, cordless phones and some medical or scientific instruments to prevent signal interference.

18.2 Troubleshooting Checklist

- A. When the tablet does not work properly:
- Make sure the tablet has been registered online.

- Make sure the system software and diagnostic application software are properly updated.
 - Make sure the tablet is connected to the Internet.
 - Check all cables, connections, and indicators to see if the signal is being received.
- B. When battery life is shorter than usual:
- This may happen when you are in an area with low signal strength. Turn off your device if is not in use.
- C. When you cannot turn on the tablet:
- Make sure the tablet is connected to a power source or the battery is charged.
- D. When you are unable to charge the tablet:
- Your charger maybe out of order. Contact your nearest dealer.
 - You may be attempting to use the device in an overly hot/cold temperature. Charge the device in a cooler or warmer area.
 - Your device may have not been connected to the charger properly. Check the connector.

 **NOTE**

If the problems persist, please contact Autel's technical support personnel or your local selling agent.

18.3 About Battery Usage

Your tablet is powered by a built-in lithium-ion polymer battery, which enables you to recharge your battery when there is electricity left.

 **DANGER**

The built-in Lithium-ion Polymer battery is factory replaceable only; incorrect replacement or tampering with the battery pack may cause an explosion.

- Do not use a damaged battery charger.
- Do not disassemble or open crush, bend, deform, puncture or shred.
- Do not modify, remanufacture or attempt to insert foreign objects into the battery, or expose the battery to fire, explosion or another hazards.
- Only use the specified charger and USB cables. Failure to use Autel-authorized charger and/or USB cables, may result in device malfunction or failure.

- Use of an unqualified battery or charger may present a risk of fire, explosion, leakage, or another hazards.
- Avoid dropping the tablet. If the tablet is dropped, especially on a hard surface, and you suspect damage, take the tablet to a service center for inspection.
- Try to keep closer to your wireless router to reduce battery usage.
- The time needed to recharge the battery varies depending on the remaining battery capacity.
- Battery life inevitably shortens over time.
- Unplug the charger once the tablet is fully charged since overcharging may shorten battery life.
- Keep the battery in temperate environments. Do not place it inside a car when it is too hot or too cold, which may reduce the capacity and life of the battery.

18.4 Service Procedures

This section introduces information for technical support, repair service, and application for replacement or optional parts.

18.4.1 Technical Support

If you have any question or problem on the operation of the product, please contact us.

AUTEL NORTH AMERICA

- **Phone:** 1-855-AUTEL-US (855-288-3587) Monday-Friday 9am-6pm EST
- **Website:** sales@autel.com, www.autel.com
- **Email:** ussupport@autel.com
- **Address:** 175 Central Avenue, Suite 200, Farmingdale, New York, USA 11735

AUTEL EUROPE

- **Phone:** 0049 (0) 6103-2000520
- **Website:** www.autel.eu
- **Email:** sales.eu@autel.com, support.eu@autel.com
- **Address:** Robert-Bosch-Strasse 25, 63225, Langen, Germany

AUTEL CHINA HQ

- **Phone:** 0086-755-2267-2493

- **Website:** www.autel.com
- **Email:** sales@auteltech.net, support@autel.com
- **Address:** 7th, 8th and 10th Floor, Building B1, Zhiyuan, Xueyuan Road, Xili, Nanshan, Shenzhen, 518055, China

AUTEL LATIN AMERICA

- **Website:** www.autel.com
- **Email:** sales.latin@autel.com; latsupport@autel.com
- **Address:** Avenida Americas 1905, 6B, Colonia Aldrete, Guadalajara, Jalisco, Mexico

AUTEL APAC

- **Phone:** +045 5948465
- **Email:** sales.jp@autel.com; support.jp@autel.com
- **Address:** 719, Nissou Building, 3-7-18, Shinyokohama, Kouhoku, Yokohama, Kanagawa, Japan 222-0033
- **Website:** www.autel.com/jp/

AUTEL IMEA DMCC

- **Website:** www.autel.com
- **Phone:** +971 585 002709
- **Email:** sales.imea@autel.com, imea-support@autel.com
- **Address:** Office 1006-1010, Cluster C, Fortune Tower, Jumeirah Lakes Tower (JLT), Dubai, U.A.E

For technical assistance in other markets, please contact your local selling agent.

18.4.2 Repair Service

If it becomes necessary to return your device for repair, please download the repair service form from www.autel.com, and fill in the form. The following information must be included:

- Contact name
- Return address
- Telephone number
- Product name
- Complete description of the problem
- Proof-of-purchase for warranty repairs

- Preferred method of payment for non-warranty repairs



NOTE

For non-warranty repairs, payment can be made with Visa, Master Card, or with approved credit terms.

Send the device to your local agent, or to the below address:

7-8th, 10th Floor, Building B1, Zhiyuan,

Xueyuan Road, Xili, Nanshan,

Shenzhen, 518055, China

18.4.3 Other Services

You can purchase the optional accessories directly from Autel's authorized tool suppliers, and/or your local distributor or agent.

Your purchase order should include the following information:

- Contact information
- Product or part name
- Item description
- Purchase quantity

19 Compliance Information

FCC Compliance

FCC ID: WQ8MAXISYSULTRA

This equipment has been tested and found to comply with the limits for a Class B digital device, pursuant to Part 15 of the FCC Rules. These limits are designed to provide reasonable protection against harmful interference in a residential installation. This equipment generates uses and can radiate radio frequency energy and, if not installed and used in accordance with the instructions, may cause harmful interference to radio communications. However, there is no guarantee that interference will not occur in a particular installation. If this equipment does cause harmful interference to radio or television reception, which can be determined by turning the equipment off and on, the user is encouraged to try to correct the interference by one or more of the following measures:

- Reorient or relocate the receiving antenna.
- Increase the separation between the equipment and receiver.
- Consult the dealer or an experienced radio/TV technician for help.

This device complies with part 15 of the FCC Rules. Operation is subject to the following two conditions:

- (1) This device may not cause harmful interference, and
- (2) This device must accept any interference received, including interference that may cause undesired operation.

Changes or modifications not expressly approved by the party responsible for compliance could void the user's authority to operate the equipment.

SAR

The radiated output power of this device is below the FCC radio frequency exposure limits. Nevertheless, the device should be used in such a manner that the potential for human contact is minimized during normal operation.

The exposure standard for wireless devices employs a unit of measurement known as the Specific Absorption Rate, or SAR. The SAR limit set by the FCC is 1.6 W/Kg. Tests for SAR are conducted using standard operating positions accepted by the FCC with the

device transmitting at its highest certified power level in all tested frequency bands. Although the SAR is determined at the highest certified power level, the actual SAR level of the device while operating can be well below the maximum value. This is because the device is designed to operate at multiple power levels so as to use only the power required to reach the network. To avoid the possibility of exceeding the FCC radio frequency exposure limits, human proximity to antenna should be minimized.

20 Warranty

20.1 12-Month Limited Warranty

Autel Intelligent Technology Corp., Ltd. (the Company) warrants to the original retail purchaser of this MaxiSys Diagnostic Device that should this product or any part thereof during normal usage and under normal conditions be proven defective in material or workmanship that results in product failure within twelve (12) months period from the date of purchase, such defect(s) will be repaired, or replaced (with new or rebuilt parts) with Proof of Purchase, at the Company's option, without charge for parts or labor directly related to the defect(s).

The Company shall not be liable for any incidental or consequential damages arising from the use, misuse, or mounting of the device. Some states do not allow limitation on how long an implied warranty lasts, so the above limitations may not apply to you.

This warranty does not apply to:

- a) Products subjected to abnormal use or conditions, accident, mishandling, neglect, unauthorized alteration, misuse, improper installation or repair or improper storage;
- b) Products whose mechanical serial number or electronic serial number has been removed, altered or defaced;
- c) Damage from exposure to excessive temperatures or extreme environmental conditions;
- d) Damage resulting from connection to, or use of any accessory or other product not approved or authorized by the Company;
- e) Defects in appearance, cosmetic, decorative or structural items such as framing and non-operative parts.
- f) Products damaged from external causes such as fire, dirt, sand, battery leakage, blown fuse, theft or improper usage of any electrical source.

! IMPORTANT

All contents of the product may be deleted during the process of repair. You should create a back-up copy of any contents of your product before delivering the product for warranty service.
