

NP SMART 5 in 1 tool

[Instructions for use V1]

Thanks for your purchasing, in order to you can understand and use the tool, please read the manual. please keep it for future reference after you reading.

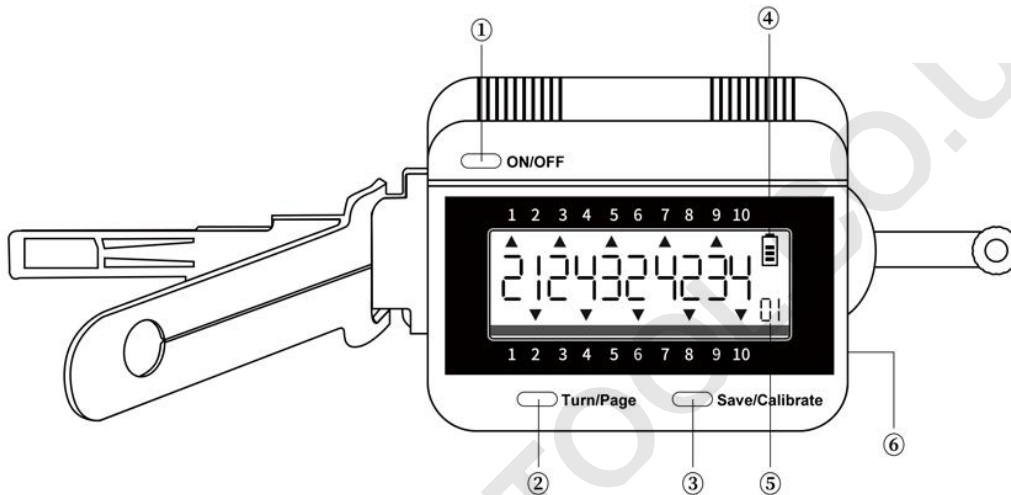

- ① On/off button
- ② Save pick number button
- ③ Lock/modify button
- ④ Battery capacity
- ⑤ Save pick number quantity
- ⑥ Android interface

Outline

Smart 5 in 1 tool is a tool with LED indicator light, unlocking, readout, data storage, auto-calibration.

Battery Installation

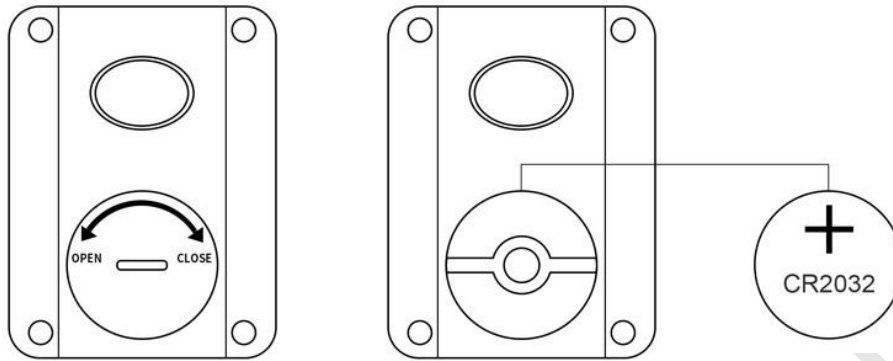

1. Turn the battery cover in the direction of the arrow

2. Insert the battery in the direction of the battery label

3. battery install direction

Button description

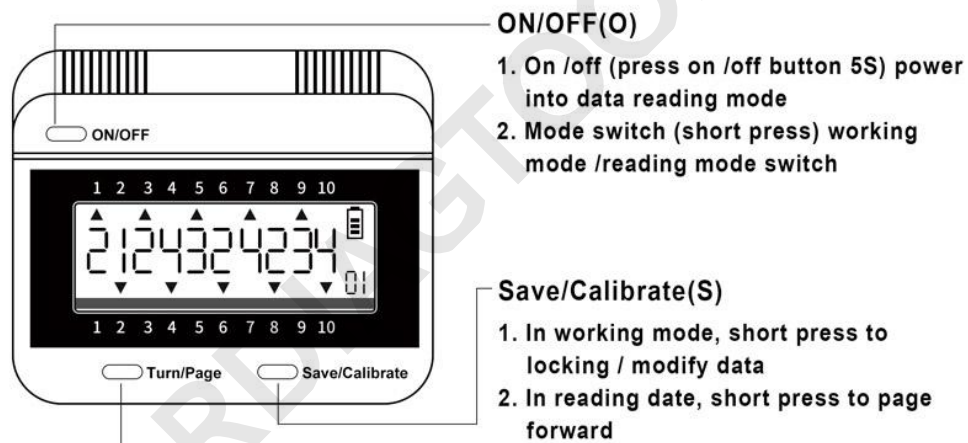

Turn/Page(T)

1. In working mode , short press to turn on
2. In reading mode , short press to next page
3. In working mode , long press to save a set of data

Operational Steps

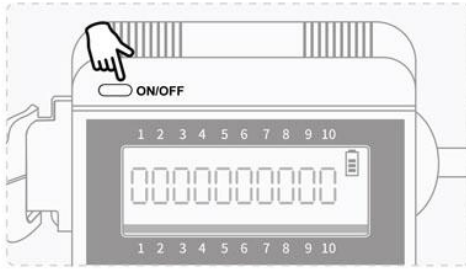

1. Long press "O" button to power on

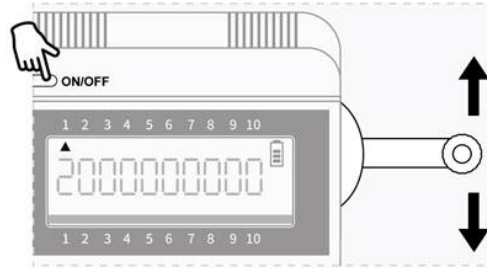

2. Short press "O" button until the indicator light on, moving the pick up and down to change the data

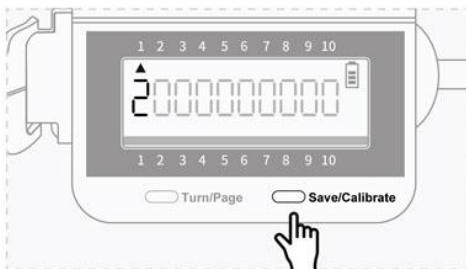

3. Short press "S" to lock the value

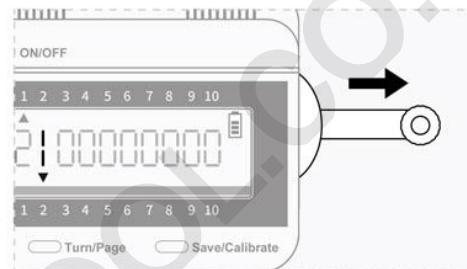

4. Continue to pull out the pick, change the data in second position

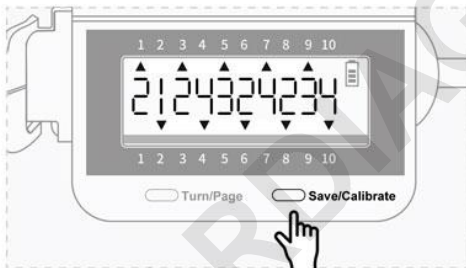

5. Press "S" button to lock data after changing the data, Repeat the previous steps until all data is changed.

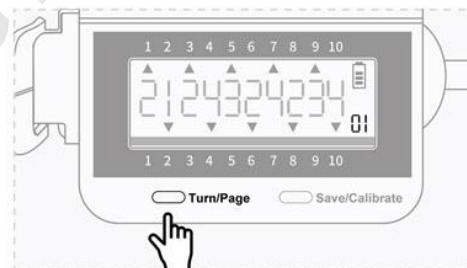

6. Long press "T" button to save data, a set of data has been stored in the bottom right corner, and the data has been saved successfully

Reading Pick Steps

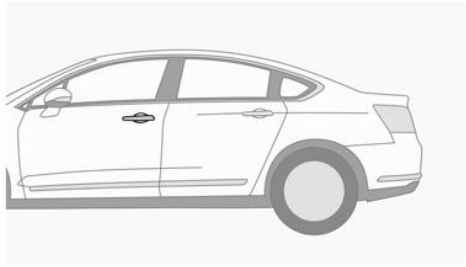

1. Opening the car lock

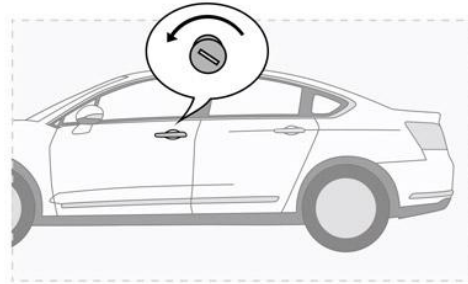

2. Switching the lock to read data in fixed position

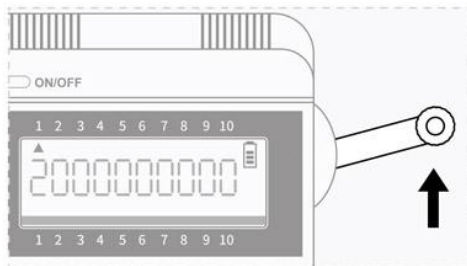

3. Select the direction where pick has no force to read the code

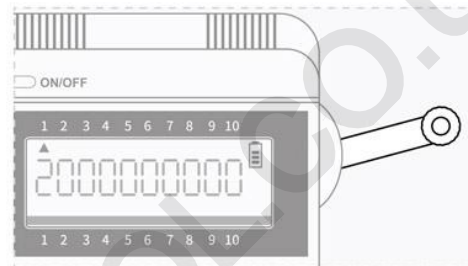

4. Turn the pick to the end for the pick number

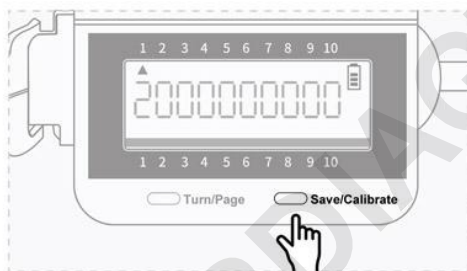

5. Press "S" button to lock single data after reading

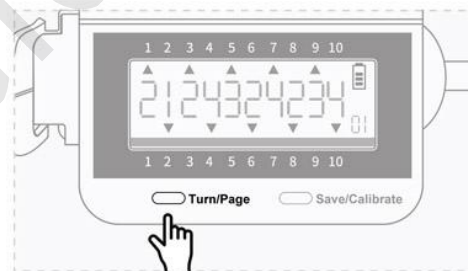

6. Long press "T" button to save data after reading

WWW.CARPICKING.COM

Code Interpretation

Error code	Description	Approach
Err-01	X axis overstep the lock	Pick returns to the initial position, turn off and restart.
Err-02	Y axis overstep the lock	Pick returns to the initial position, turn off and restart.
Err-03	Save failed	Press the save button again, please check the hardware after multiple failures
Err-04	Full storage	<ol style="list-style-type: none">1. long press 3S "T" button until the screen flash 3 times , so clean storage data, put and save the current data as the first storage data2. Don't save the current data, switch to working mode

WWW.CARDIAGTOOLS.COM

Specifications

Display screen	LCD with white backlight board
Data bit light	Red LED with number, double instructions
Battery	DC3.3V (CR2032)
Support storage capacity	12 sets data
Power consumption	About 30-50 times
Operating temperature	-20°C - 45°C
Working humidity	Humidity under 95% (No condensation)
Gross weight	160g
Size	160MM*70MM*40MM

Precautions

1. When the battery shows only one bar left, please use the new battery in time, avoid affecting normal use
2. Please use 3.3V, CR2032 battery, cannot use other battery specifications